

SK8N

User Guide



Motherboard

E1311

First Edition

June 2003

Copyright © 2003 ASUSTeK COMPUTER INC. All Rights Reserved.

No part of this manual, including the products and software described in it, may be reproduced, transmitted, transcribed, stored in a retrieval system, or translated into any language in any form or by any means, except documentation kept by the purchaser for backup purposes, without the express written permission of ASUSTeK COMPUTER INC. ("ASUS").

Product warranty or service will not be extended if: (1) the product is repaired, modified or altered, unless such repair, modification or alteration is authorized in writing by ASUS; or (2) the serial number of the product is defaced or missing.

ASUS PROVIDES THIS MANUAL "AS IS" WITHOUT WARRANTY OF ANY KIND, EITHER EXPRESS OR IMPLIED, INCLUDING BUT NOT LIMITED TO THE IMPLIED WARRANTIES OR CONDITIONS OF MERCHANTABILITY OR FITNESS FOR A PARTICULAR PURPOSE. IN NO EVENT SHALL ASUS, ITS DIRECTORS, OFFICERS, EMPLOYEES OR AGENTS BE LIABLE FOR ANY INDIRECT, SPECIAL, INCIDENTAL, OR CONSEQUENTIAL DAMAGES (INCLUDING DAMAGES FOR LOSS OF PROFITS, LOSS OF BUSINESS, LOSS OF USE OR DATA, INTERRUPTION OF BUSINESS AND THE LIKE), EVEN IF ASUS HAS BEEN ADVISED OF THE POSSIBILITY OF SUCH DAMAGES ARISING FROM ANY DEFECT OR ERROR IN THIS MANUAL OR PRODUCT.

SPECIFICATIONS AND INFORMATION CONTAINED IN THIS MANUAL ARE FURNISHED FOR INFORMATIONAL USE ONLY, AND ARE SUBJECT TO CHANGE AT ANY TIME WITHOUT NOTICE, AND SHOULD NOT BE CONSTRUED AS A COMMITMENT BY ASUS. ASUS ASSUMES NO RESPONSIBILITY OR LIABILITY FOR ANY ERRORS OR INACCURACIES THAT MAY APPEAR IN THIS MANUAL, INCLUDING THE PRODUCTS AND SOFTWARE DESCRIBED IN IT.

Products and corporate names appearing in this manual may or may not be registered trademarks or copyrights of their respective companies, and are used only for identification or explanation and to the owners' benefit, without intent to infringe.

Contents

Notices	vi
Safety information	vii
About this guide	viii
How this guide is organized	viii
Conventions used in this guide	ix
Where to find more information	ix
ASUS contact information	x
SK8N specifications summary	xi

Chapter 1: Product introduction

1.1 Welcome!	1-1
1.2 Package contents	1-1
1.3 Special features	1-2
1.3.1 Product highlights	1-2
1.3.2 Value-added solutions	1-5
1.4 Motherboard overview	1-6
1.4.1 Major components	1-6
1.4.2 Core specifications	1-8

Chapter 2: Hardware information

2.1 Motherboard installation	2-1
2.1.1 Placement direction	2-1
2.1.2 Screw holes	2-1
2.2 Motherboard layout	2-2
2.3 Before you proceed	2-3
2.4 Central Processing Unit (CPU)	2-4
2.4.1 Overview	2-4
2.4.2 Installing the CPU	2-5
2.4.3 Installing the heatsink and fan	2-7
2.4.4 Connecting the CPU Fan cable	2-9
2.4.5 CPU heatsink and fan qualified vendor list	2-10
2.5 System memory	2-11
2.5.1 Overview	2-11
2.5.2 Memory configurations	2-12
2.5.3 Installing a DIMM	2-14
2.5.4 Removing a DIMM	2-14

Contents

2.6	Expansion slots	2-15
2.6.1	Installing an expansion card	2-15
2.6.2	Configuring an expansion card	2-15
2.6.3	PCI slots	2-17
2.6.4	AGP slot	2-18
2.7	Jumpers	2-19
2.8	Connectors	2-21

Chapter 3: Powering up

3.1	Starting up for the first time	3-1
3.2	Powering off the computer	3-2

Chapter 4: BIOS setup

4.1	Managing and updating your BIOS	4-1
4.1.1	Creating a bootable floppy disk	4-1
4.1.2	Using AFUDOS to update the BIOS	4-1
4.1.3	Using AFUDOS to copy BIOS from PC	4-3
4.1.4	Using ASUS EZ Flash to update the BIOS	4-4
4.1.5	Recovering the BIOS with CrashFree BIOS 2	4-5
4.2	BIOS Setup program	4-7
4.2.1	BIOS menu screen	4-8
4.2.2	Menu bar	4-8
4.2.3	Navigation keys	4-8
4.2.4	Menu items	4-9
4.2.5	Sub-menu items	4-9
4.2.6	Configuration fields	4-9
4.2.7	Pop-up window	4-9
4.2.8	Scroll bar	4-9
4.2.9	General help	4-9
4.3	Main menu	4-10
4.3.1	System Time [xx:xx:xxxx]	4-10
4.3.2	System Date [Day xx/xx/xxxx]	4-10
4.3.3	Legacy Diskette A [1.44M, 3.5 in.]	4-10
4.3.4	Primary and Secondary IDE Master/Slave	4-11
4.3.5	System Information	4-12
4.4	Advanced menu	4-13
4.4.1	CPU Configuration	4-13
4.4.2	Chipset	4-14
4.4.3	Onboard Devices Configuration	4-22
4.4.4	PCI PnP	4-23

Contents

4.5	Power menu	4-25
4.5.1	ACPI Suspend Mode [Auto]	4-25
4.5.2	Repost Video on S3 Resume [No]	4-25
4.5.3	ACPI 2.0 Support [No]	4-25
4.5.4	ACPI APIC Support [Enabled]	4-25
4.5.5	BIOS -> AML ACPI Table [Enabled]	4-25
4.5.6	APM Configuration	4-26
4.5.7	Hardware Monitor	4-27
4.6	Boot menu	4-29
4.6.1	Boot Device Priority	4-29
4.6.2	Boot Settings Configuration	4-30
4.6.3	Security	4-32
4.7	Exit menu	4-34

Chapter 5: Software support

5.1	Install an operating system	5-1
5.2	Support CD information	5-1
5.2.1	Running the support CD	5-1
5.2.2	Drivers menu	5-2
5.2.3	Utilities menu	5-3
5.2.4	ASUS Contact Information	5-4
5.2.5	Other information	5-5
5.3	Software information	5-7
5.3.1	ASUS Update	5-7
5.3.2	ASUS MyLogo2™	5-8
5.3.3	ASUS PC Probe	5-10
5.3.4	Multi-channel Audio Feature	5-15
5.4	RAID configurations	5-17
5.4.1	Install the hard disks	5-18
5.4.2	Enter the MBFastBuild™ utility	5-19
5.4.3	Creating a RAID 0 array (Performance)	5-20
5.4.4	Creating a RAID 1 array (Security)	5-21
5.4.5	Other FastBuild Utility Commands	5-23
5.5	Using Makedisk.exe	5-25

Notices

Federal Communications Commission Statement

This device complies with FCC Rules Part 15. Operation is subject to the following two conditions:

- This device may not cause harmful interference, and
- This device must accept any interference received including interference that may cause undesired operation.

This equipment has been tested and found to comply with the limits for a Class B digital device, pursuant to Part 15 of the FCC Rules. These limits are designed to provide reasonable protection against harmful interference in a residential installation. This equipment generates, uses and can radiate radio frequency energy and, if not installed and used in accordance with manufacturer's instructions, may cause harmful interference to radio communications. However, there is no guarantee that interference will not occur in a particular installation. If this equipment does cause harmful interference to radio or television reception, which can be determined by turning the equipment off and on, the user is encouraged to try to correct the interference by one or more of the following measures:

- Reorient or relocate the receiving antenna.
- Increase the separation between the equipment and receiver.
- Connect the equipment to an outlet on a circuit different from that to which the receiver is connected.
- Consult the dealer or an experienced radio/TV technician for help.



The use of shielded cables for connection of the monitor to the graphics card is required to assure compliance with FCC regulations. Changes or modifications to this unit not expressly approved by the party responsible for compliance could void the user's authority to operate this equipment.

Canadian Department of Communications Statement

This digital apparatus does not exceed the Class B limits for radio noise emissions from digital apparatus set out in the Radio Interference Regulations of the Canadian Department of Communications.

This class B digital apparatus complies with Canadian ICES-003.

Safety information

Electrical safety

- To prevent electrical shock hazard, disconnect the power cable from the electrical outlet before relocating the system.
- When adding or removing devices to or from the system, ensure that the power cables for the devices are unplugged before the signal cables are connected. If possible, disconnect all power cables from the existing system before you add a device.
- Before connecting or removing signal cables from the motherboard, ensure that all power cables are unplugged.
- Seek professional assistance before using an adapter or extension cord. These devices could interrupt the grounding circuit.
- Make sure that your power supply is set to the correct voltage in your area. If you are not sure about the voltage of the electrical outlet you are using, contact your local power company.
- If the power supply is broken, do not try to fix it by yourself. Contact a qualified service technician or your retailer.

Operation safety

- Before installing the motherboard and adding devices on it, carefully read all the manuals that came with the package.
- Before using the product, make sure all cables are correctly connected and the power cables are not damaged. If you detect any damage, contact your dealer immediately.
- To avoid short circuits, keep paper clips, screws, and staples away from connectors, slots, sockets and circuitry.
- Avoid dust, humidity, and temperature extremes. Do not place the product in any area where it may become wet.
- Place the product on a stable surface.
- If you encounter technical problems with the product, contact a qualified service technician or your retailer.

About this guide

This user guide contains the information you need when installing the ASUS SK8N motherboard.

How this guide is organized

This manual contains the following parts:

- **Chapter 1: Product introduction**
This chapter describes the features of the SK8N motherboard. It includes brief descriptions of the special attributes of the motherboard and the new technology it supports.
- **Chapter 2: Hardware information**
This chapter lists the hardware setup procedures that you have to perform when installing system components. It includes description of the switches, jumpers, and connectors on the motherboard.
- **Chapter 3: Powering up**
This chapter describes the power up sequence and ways of shutting down the system.
- **Chapter 4: BIOS setup**
This chapter tells how to change system settings through the BIOS Setup menus. Detailed descriptions of the BIOS parameters are also provided.
- **Chapter 5: Software support**
This chapter describes the contents of the support CD that comes with the motherboard package.

Conventions used in this guide

To make sure that you perform certain tasks properly, take note of the following symbols used throughout this manual.



DANGER/WARNING: Information to prevent injury to yourself when trying to complete a task.



CAUTION: Information to prevent damage to the components when trying to complete a task.

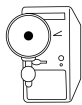

IMPORTANT: Information that you **MUST** follow to complete a task.



NOTE: Tips and additional information to aid in completing a task.

Where to find more information

Refer to the following sources for additional information and for product and software updates.

1. ASUS Websites

The ASUS websites worldwide provide updated information on ASUS hardware and software products. The ASUS websites are listed in the ASUS Contact Information on page x.

2. Optional Documentation

Your product package may include optional documentation, such as warranty flyers, that may have been added by your dealer. These documents are not part of the standard package.

ASUS contact information

ASUSTeK COMPUTER INC. (Asia-Pacific)

Address: 150 Li-Te Road, Peitou, Taipei, Taiwan 112
General Tel: +886-2-2894-3447
General Fax: +886-2-2894-3449
General Email: info@asus.com.tw

Technical Support

MB/Others (Tel): +886-2-2890-7121 (English)
Notebook (Tel): +886-2-2890-7122 (English)
Desktop/Server (Tel): +886-2-2890-7123 (English)
Support Fax: +886-2-2890-7698
Web Site: www.asus.com.tw

ASUS COMPUTER INTERNATIONAL (America)

Address: 44370 Nobel Drive, Fremont, CA 94538, USA
General Fax: +1-502-933-8713
General Email: tmd1@asus.com

Technical Support

Support Fax: +1-502-933-8713
General Support: +1-502-995-0883
Notebook Support: +1-510-739-3777 x5110
Web Site: usa.asus.com
Support Email: tsd@asus.com

ASUS COMPUTER GmbH (Germany and Austria)

Address: Harkortstr. 25, 40880 Ratingen, BRD, Germany
General Email: sales@asuscom.de (for marketing requests only)
General Fax: +49-2102-9599-31

Technical Support

Support Hotlines: (Components) +49-2102-9599-0
(Notebook PC) +49-2102-9599-10
Support Fax: +49-2102-9599-11
Support Email: www.asuscom.de/kontakt (for online support)
Web Site: www.asuscom.de

SK8N specifications summary

CPU	Socket 940 for AMD Opteron processor
Chipset	NVIDIA nForce 3 Pro150
System Bus	Scalable Hyper-Transport Bus
Memory	Dual-Channel memory architecture Supports PC2700/PC2100/PC1600 ECC DDR SDRAM Registered DIMMs 4 x 184-pin DDR DIMM sockets for up to 8GB memory
Expansion slots	1 x AGP 8X 5 x PCI
Storage	2 x UltraDMA 133/100 Promise PDC20378 RAID controller: 1 x UltraDMA 133 support for two hard drives 2 x Serial ATA RAID 0, RAID 1, RAID 0+1
Audio	ALC 650 S/PDIF out interface
LAN	CK8 MAC+ Realtek RTL8201BL PHY
USB 2.0	Integrated 6 USB 2.0 ports
IEEE 1394	2 x port at 400 Mbps transfer rate
Special Features	ASUS MyLogo2 ASUS EZ Flash Supports S/PDIF out interface ASUS CrashFree BIOS 2 ASUS Q-Fan
Internal I/O connectors	1 x USB 2.0 connector support additional 2 USB 2.0 ports 20-pin ATX power connector 4-pin ATX 12V power connector CPU/chassis/power FAN connectors COM2 connector CD/AUX audio-in IEEE 1394 connector
OverclockFeatures	ASUS Jumperfree Memory and AGP voltage adjustable SFS (Stepless Frequency Selection) from 200MHz up to 300MHz at 1MHz increment

(continued on the next page)

SK8N specifications summary

Back Panel I/O Ports	1 x Parallel 1 x Serial 1 x PS/2 Keyboard 1 x PS/2 Mouse 1 x Audio I/O 4 x USB 2.0 1 x RJ-45 Port 1 x IEEE 1394
BIOS features	4Mb Flash EEPROM AMI BIOS with enhanced ACPI, DMI, PnP, Green ASUS EZ Flash, ASUS MyLogo2, ASUS Q-Fan, CrashFree BIOS 2, SM BIOS 2.3
Industry standard	PCI 2.3, USB 2.0
Manageability	WOL by PME, WOR by PME
Form Factor	ATX form factor: 12 in x 9.6 in (30.5 cm x 24.5 cm)
Support CD contents	Device drivers ASUS PC Probe Trend Micro™ PC-cillin 2002 anti-virus software

* Specifications are subject to change without notice.

Chapter 1

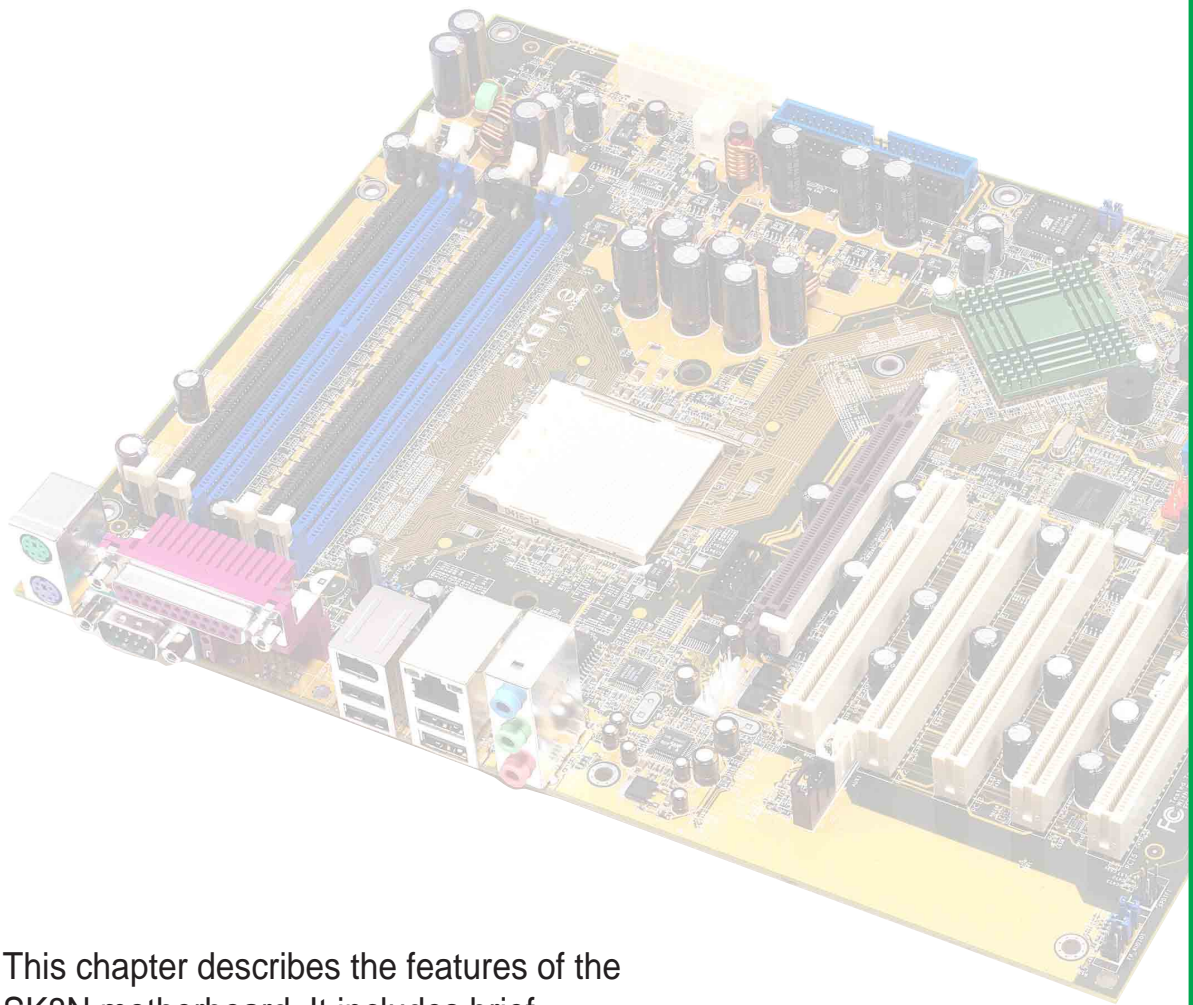

This chapter describes the features of the SK8N motherboard. It includes brief explanations of the special attributes of the motherboard and the new technology it supports.

Product introduction

Chapter summary

1.1	Welcome!	1-1
1.2	Package contents	1-1
1.3	Special features	1-2
1.4	Motherboard overview	1-6

1.1 Welcome!

Thank you for buying the ASUS® SK8N motherboard!

The ASUS SK8N motherboard delivers a host of new features and latest technologies making it another standout in the long line of ASUS quality motherboards!

The SK8N incorporates the AMD® Opteron™ Processor in a Socket 940 package that is designed for high performance workstation and server applications. It provides three high-performance HyperTransport™ links to I/O devices, as well as a 128-bit high-performance DDR SDRAM memory controller with the NVIDIA® nForce 3 Pro150 chipset that sets a new benchmark for an effective desktop platform solution.

Supporting up to 8GB of system memory with PC2700/PC2100/PC1600 DDR SDRAM registered modules, high-resolution graphics via an AGP 8X slot, Serial ATA support, RAID, IEEE 1394, USB 2.0, and 6-channel audio features, the SK8N takes you ahead in the world of power computing!

Before you start installing the motherboard, and hardware devices on it, check the items in your package with the list below.

1.2 Package contents

Check your SK8N package for the following items.

- ✓ ASUS SK8N motherboard
- ✓ ASUS support CD
- ✓ 2 x SATA cable
- ✓ 1 x USB cable
- ✓ 1 x COM2 cable
- ✓ 1 x Single port 1394 module
- ✓ S/PDIF out module
- ✓ 80-conductor ribbon cable for UltraDMA/66/100/133 IDE drives
- ✓ 40-conductor IDE cable
- ✓ Ribbon cable for a 3.5-inch floppy drive
- ✓ I/O shield
- ✓ Bag of extra jumper caps
- ✓ User Guide



If any of the above items is damaged or missing, contact your retailer.

1.3 Special features

1.3.1 Product highlights

Latest processor technology

The AMD Opteron™ processor for servers and workstations is based on AMD's 64-bit architecture, which represents the landmark introduction of the industry's first x86-64 technology. This next-generation processor provides a dramatic leap forward in compatibility, performance, investment protection, and reduced total cost of ownership and development. See page 2-4 for details.

HyperTransport™ Technology

HyperTransport™ Technology is a high-speed, low latency, point-to-point link designed to increase the communication speed between integrated circuits in computers, servers, embedded systems, and networking and telecommunications equipment up to 48 times faster than some existing technologies.

Serial ATA solution, RAID support



The motherboard supports two interfaces compliant to the Serial ATA (SATA) specification, an evolutionary replacement of the Parallel ATA storage interface. The Serial ATA specification allows for thinner, more flexible cables with lower pin count, reduced voltage requirement, up to 150 MB/s data transfer rate. With the Promise® PDC 20378 RAID controller onboard, the motherboard supports RAID 0, RAID 1 and RAID 0+1 configuration using SATA drives. See pages 2-23, 5-17.

AGP 8X support

AGP 8X (AGP 3.0) is the next generation VGA interface specification that enables enhanced graphics performance with high bandwidth speeds up to 2.12 GB/s. See page 2-18.

6-Channel Audio solution

The SK8N uses an onboard audio CODEC that lets you enjoy high-quality 6-channel audio without having to buy advanced sound cards. See page 5-15.

S/PDIF out

The SK8N's S/PDIF out function turns your computer into a high-end entertainment system with digital connectivity to powerful speaker systems.

IEEE 1394 support

The IEEE 1394 interface provides high-speed and flexible PC connectivity to a wide range of peripherals and devices compliant to IEEE 1394a standards. The IEEE 1394 interface allows up to 400Mbps transfer rates through simple, low-cost, high-bandwidth asynchronous (real-time) data interfacing between computers, peripherals, and consumer electronic devices such as camcorders, VCRs, printers, TVs, and digital cameras. See page 2-28.

USB 2.0 technology

The motherboard implements the new Universal Serial Bus (USB) 2.0 specification, extending the connection speed from 12 Mbps on USB 1.1 to a fast 480 Mbps on USB 2.0 - supporting up to 6 USB 2.0 ports. The higher bandwidth of USB 2.0 allows connection of devices such as high resolution video conferencing cameras, next generation scanners and printers, and fast storage units. USB 2.0 is backward compatible with USB 1.1. See page 2-20.

ASUS MyLogo2™

This new feature present in the SK8N motherboard allows you to personalize and add style to your system with customizable boot logos. See pages 4-30, 5-8.

ASUS EZ Flash BIOS

With the ASUS EZ Flash, you can easily update the system BIOS even before loading the operating system. No need to use a DOS-based utility or boot from a floppy disk. See page 4-4.

ASUS Q-Fan technology

The ASUS Q-Fan technology smartly adjusts the fan speeds according to the system loading to ensure quiet, cool, and efficient operation. See page 4-28.

CrashFree BIOS 2

This feature allows you to restore the original BIOS data from the ASUS support CD in case when the BIOS codes and data are corrupted. This protection eliminates the need to buy a replacement ROM chip. See page 4-5.

BONUS!

Free bundled TrendMicro™ PC-cillin 2002 anti-virus software (OEM version)

1.3.2 Value-added solutions

Temperature, fan, and voltage monitoring

The CPU temperature is monitored by the IT8712F to prevent overheating and damage. The system fan rotations per minute (RPM) is monitored for timely failure detection. The system voltage levels are monitored to ensure stable supply of current for critical components.

ASUS update

This utility allows you to update the motherboard BIOS through a user-friendly interface. Connect to the Internet then to the ASUS FTP site nearest you to obtain the latest BIOS version for your motherboard.

1.4 Motherboard overview

Before you install the SK8N motherboard, familiarize yourself with its physical configuration and available features to facilitate the motherboard installation and future upgrades. A sufficient knowledge of the motherboard specifications will also help you avoid mistakes that may damage the board and its components.

1.4.1 Major components

The following are the major components of the SK8N motherboard as pointed out in the picture on page 1-7.

1. DDR DIMM sockets
2. CPU socket
3. 12V ATX power connector
4. ATX Power connector
5. IDE connectors
6. Flash ROM
7. System chipset
8. Super I/O controller
9. Floppy disk connector
10. RAID Ultra ATA/133 connector
11. Standby power LED
12. IEEE 1394 controller
13. Serial ATA controller
14. Serial ATA connectors
15. PCI slots
16. AGP slot
17. Audio CODEC
18. LAN PHY
19. PS/2 Mouse
20. Parallel port
21. IEEE 1394 port
22. RJ-45 port
23. Line In jack
24. Line Out jack
25. Microphone jack
26. USB 2.0 ports 1 and 2
27. USB 2.0 ports 3 and 4
28. Serial port
29. Keyboard port



See page 1-8 for the specifications of each component. Refer to Chapter 2 for detailed information on the components.

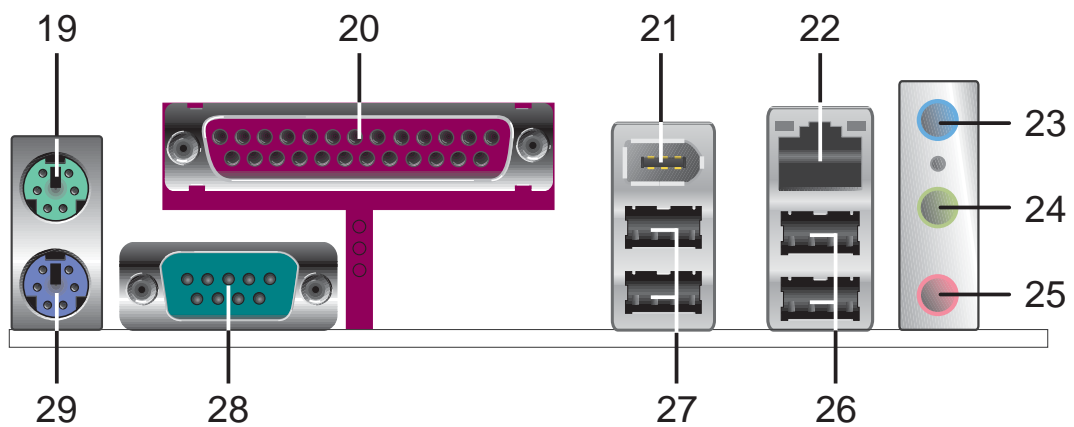
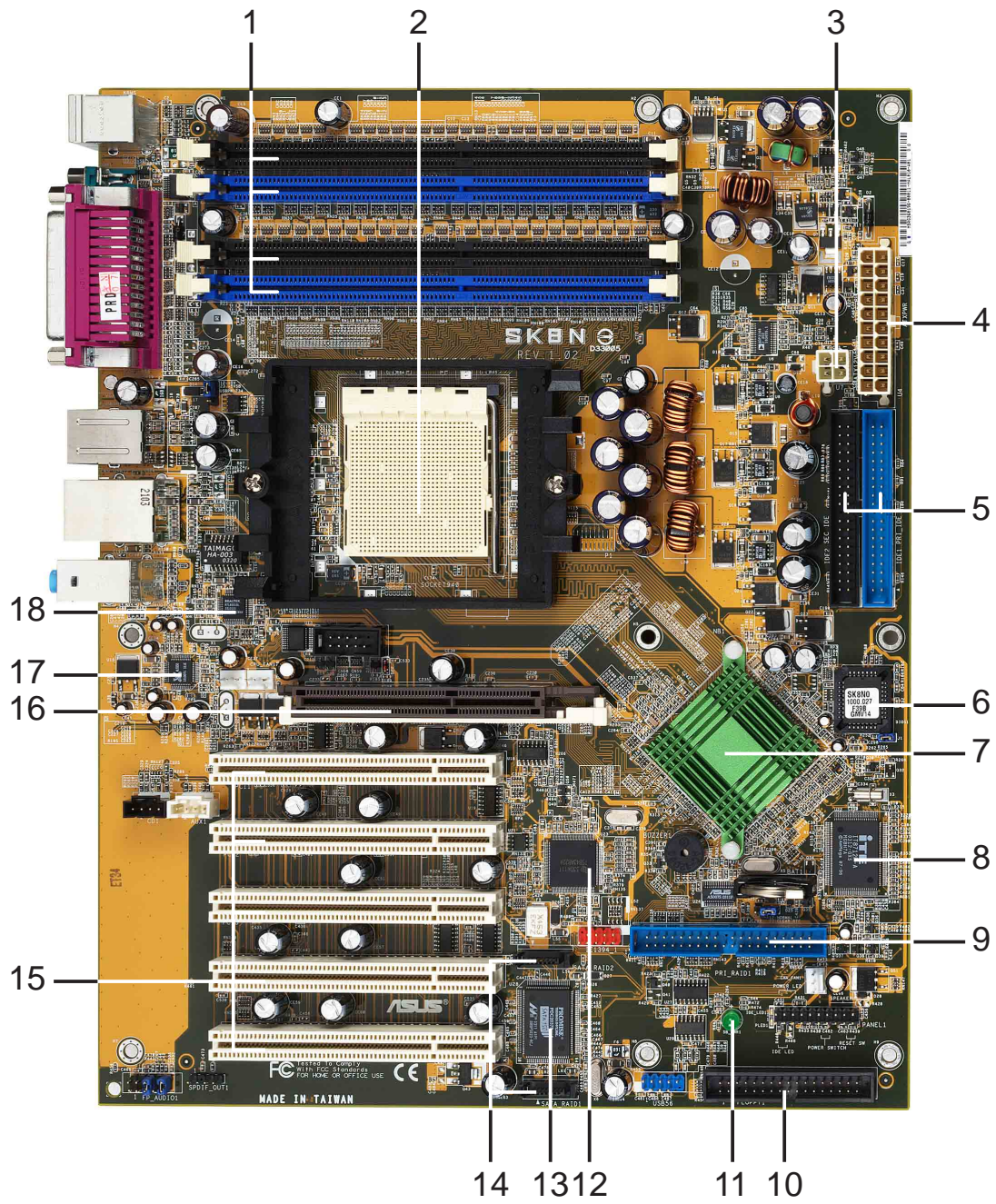

1.4.2 Core specifications

- 1 DDR DIMM sockets.** These four 184-pin DIMM sockets support up to 8GB system memory using registered ECC PC2700/2100/1600 DDR DIMMs.
- 2 CPU socket.** A 940-pin surface mount, Zero Insertion Force (ZIF) socket designed for the AMD® Opteron™ processor with an integrated low-latency high-bandwidth memory controller and a highly-scalable HyperTransport™ technology-based system bus.
- 3 ATX 12V connector.** This power connector connects the 4-pin 12V plug from the ATX 12V power supply.
- 4 ATX power connector.** This 20-pin connector connects to an ATX +12V power supply. The power supply must have at least 1.5A on the +5V standby lead (+5VSB).
- 5 IDE connectors.** These dual-channel bus master IDE connectors support Ultra DMA133/100, PIO Modes 3 & 4 IDE devices. Both the primary (blue) and secondary (black) connectors are slotted to prevent incorrect insertion of the IDE ribbon cable.
- 6 Flash ROM.** This 4Mb firmware contains the programmable BIOS program.
- 7 System chipset.** The Nvidia® nForce 3 Pro 150 is a low-latency subsystem that provides an extremely fast dedicated HyperTransport link that sets the communication with the CPU at up to 3.6 GB/s, a speed that ensures ample bandwidth for integrated support for AGP, PCI, Serial ATA and other devices.
- 8 Super I/O controller.** The ITE IT8712F-A interface provides the commonly used Super I/O functionality. The chipset supports a high-performance floppy disk controller for a 360K/720K/1.44M/2.88M floppy disk drive, a multi-mode parallel port, 2 serial ports, the mouse and keyboard interface and the LPC (Low Pin Count) interface.
- 9 Floppy disk connector.** This connector accommodates the provided ribbon cable for the floppy disk drive. One side of the connector is slotted to prevent incorrect insertion of the floppy disk cable.
- 10 RAID ATA133 connector.** This bus master IDE connector supports Ultra DMA/133 IDE devices. This connector is slotted to prevent incorrect insertion of the IDE ribbon cable.

- 11 Standby power LED.** This LED lights up if there is a standby power on the motherboard. This LED acts as a reminder to turn off the system power before plugging or unplugging devices.
- 12 IEEE 1394 controller.** The Texas Instruments TSB43AB22A device is an integrated 1394a-2000 OHCI PHY/link-layer controller (LLC) device that is fully compliant with the PCI Local Bus Specification, the PCI Bus Power Management Interface Specification, IEEE Std 1394-1995, IEEE Std 1394a-2000, and the 1394 Open Host Controller Interface Specification. It is capable of transferring data between the 33-MHz PCI bus and the 1394 bus at 100M bits/s, 200M bits/s, and 400M bits/s.
- 13 SATA RAID controller.** The Promise® PDC20378 RAID controller provides high-performance RAID 0/RAID 1/RAID 0+1. Together with the UltraDMA133 devices, if present, the Serial ATA RAID devices may be set up as a multi-RAID configuration.
- 14 SATA connectors.** These two 7-pin connectors support Serial ATA HDDs and allows for up to 150MB/s data transfer rate, faster than the standard Parallel ATA with 133 MB/s.
- 15 PCI slots.** These five 32-bit PCI 2.3 expansion slots support bus master PCI cards like SCSI or LAN cards with 133MB/s maximum throughput.
- 16 AGP slot.** This Accelerated Graphics Port (AGP) slot supports 1.5V AGP8X mode graphics cards for 3D graphical applications.
- 17 Audio CODEC.** The Realtek® ALC 650 is an AC'97 CODEC that allows 6-channel audio playback. The audio CODEC provides six DAC channels for 5.1 surround sound, AUX and Line In stereo inputs, and an integrated headphone amplifier.
- 18 LAN PHY.** The Realtek® RTL8201BL Ethernet PHY with the CK8 MAC forms a solution for LAN on Motherboard (LOM) application. They support 100/10 Mbps data transfer rates.
- 19 PS/2 mouse port.** This green 6-pin connector is for a PS/2 mouse.
- 20 Parallel port.** This 25-pin port connects a parallel printer, a scanner, or other devices.
- 21 IEEE1394 port.** This 6-pin IEEE 1394 port provides high-speed connectivity for audio/video devices, storage peripherals, other PCs and/or portable devices.

- 22** **RJ-45 port.** This port allows connection to a Local Area Network (LAN) through a network hub.
- 23** **Line In jack.** This Line In (light blue) jack connects a tape player or other audio sources. In 6-channel mode, the function of this jack becomes Rear Speaker Out.
- 24** **Line Out jack.** This Line Out (lime) jack connects a headphone or a speaker. In 6-channel mode, the function of this jack becomes Front Speaker Out.
- 25** **Microphone jack.** This Mic (pink) jack connects a microphone. In 6-channel mode, the function of this jack becomes Bass/Center Speaker Out.
- 26** **USB 2.0 ports 1 and 2.** These two 4-pin Universal Serial Bus (USB) ports are available for connecting USB 2.0 devices.
- 27** **USB 2.0 ports 3 and 4.** These two 4-pin Universal Serial Bus (USB) ports are available for connecting USB 2.0 devices.
- 28** **Serial port.** This 9-pin COM1 port is for pointing devices or other serial devices.
- 29** **PS/2 keyboard port.** This purple connector is for a PS/2 keyboard.

Chapter 2

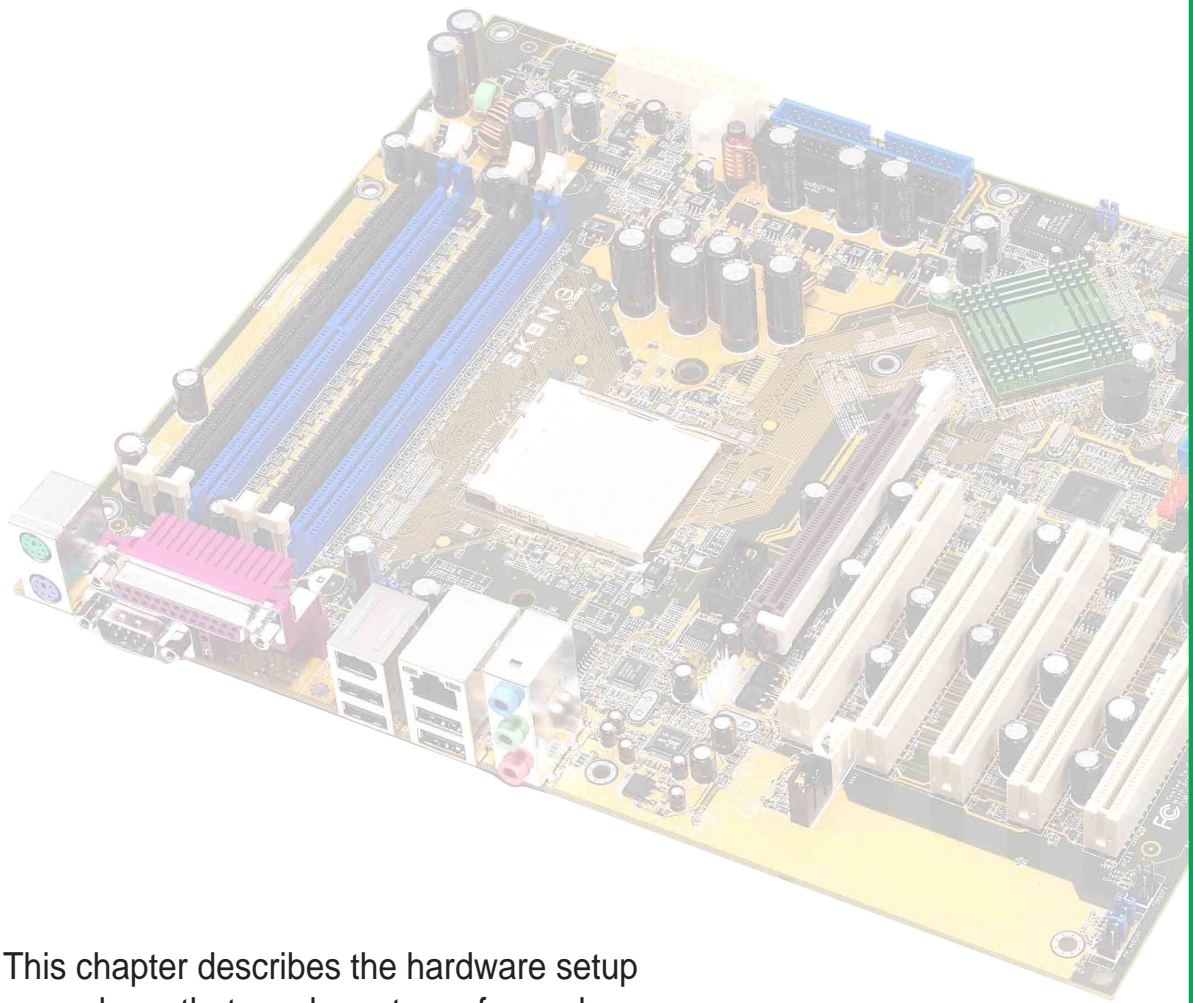

This chapter describes the hardware setup procedures that you have to perform when installing system components. It includes details on the switches, jumpers, and connectors on the motherboard.

Hardware information

Chapter summary

2.1	Motherboard installation	2-1
2.2	Motherboard layout	2-2
2.3	Before you proceed	2-3
2.4	Central Processing Unit (CPU)	2-4
2.5	System memory	2-11
2.6	Expansion slots	2-15
2.7	Jumpers	2-19
2.8	Connectors	2-21

2.1 Motherboard installation

Before you install the motherboard, study the configuration of your chassis to ensure that the motherboard fits into it. The SK8N uses the ATX form factor that measures 12 inches x 9.6 inches.



Make sure to unplug the power cord before installing or removing the motherboard. Failure to do so may cause you physical injury and damage motherboard components.

2.1.1 Placement direction

When installing the motherboard, make sure that you place it into the chassis in the correct orientation. The edge with external ports goes to the rear part of the chassis as indicated in the image below.

2.1.2 Screw holes

Place nine (9) screws into the holes indicated by circles to secure the motherboard to the chassis.



Do not overtighten the screws! Doing so may damage the motherboard.

Place this side towards the rear of the chassis

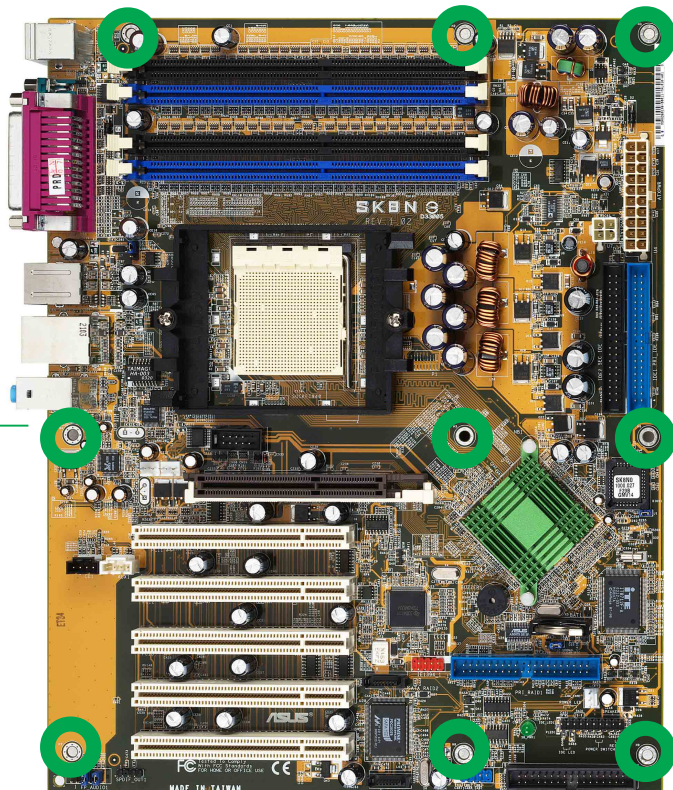

2.2 Motherboard layout

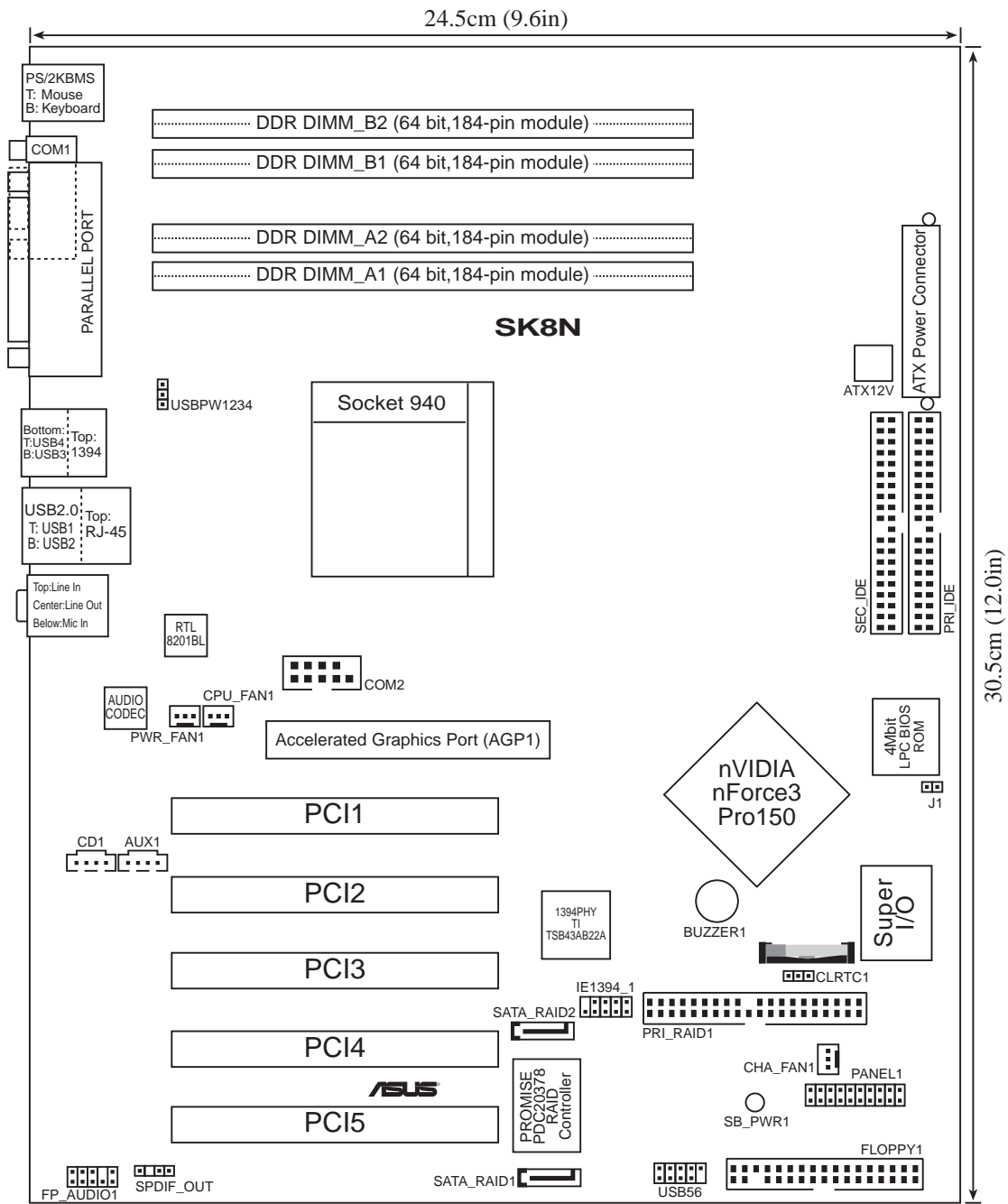

2.3 Before you proceed

Take note of the following precautions before you install motherboard components or change any motherboard settings.



1. Unplug the power cord from the wall socket before touching any component.
2. Use a grounded wrist strap or touch a safely grounded object or to a metal object, such as the power supply case, before handling components to avoid damaging them due to static electricity.
3. Hold components by the edges to avoid touching the ICs on them.
4. Whenever you uninstall any component, place it on a grounded antistatic pad or in the bag that came with the component.
5. **Before you install or remove any component, ensure that the ATX power supply is switched off or the power cord is detached from the power supply.** Failure to do so may cause severe damage to the motherboard, peripherals, and/or components.

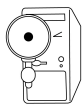

When lit, the green LED (SB_PWR1) indicates that the system is ON, in sleep mode, or in soft-off mode, a reminder that you should shut down the system and unplug the power cable before removing or plugging in any motherboard component.

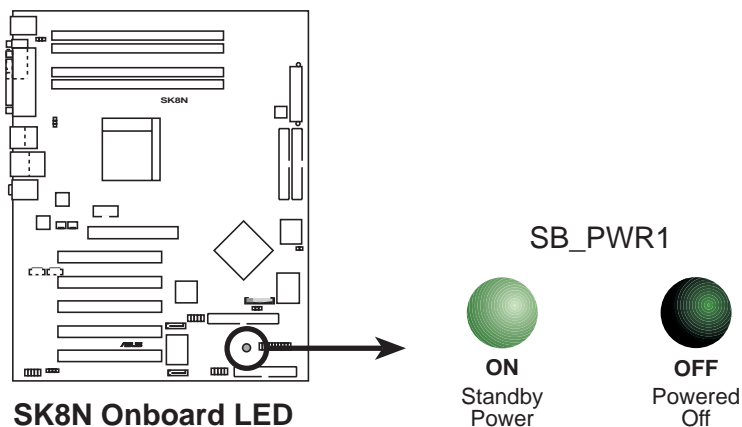

2.4 Central Processing Unit (CPU)

2.4.1 Overview

The motherboard comes with a surface mount 940-pin Zero Insertion Force (ZIF) socket. The socket is designed for the new AMD Opteron™ Processor in the 940-pin lidded ceramic micro PGA package. The AMD Opteron™ processor is a 64-bit server and workstation processor based on the industry-standard x86 instruction set architecture that can run x86-based 32 and 64-bit applications. Integrated with the processor is a low-latency high-bandwidth memory controller and a highly scalable HyperTransport™ technology-based system bus. Also, the processor includes Error Correcting Code (ECC) protection for L1 and L2 cache data and DRAM ECC protection with chipkill.

Additionally, the 128-bit-wide data paths of the AMD Opteron™ processor run applications faster than traditional processors with only 32 or 64-bit wide data paths. Current 32-bit processors have a 4 gigabyte memory addressing cap; the AMD Opteron™ has a 40-bit physical and 48-bit virtual addressing cap that enable systems to address up to 1 terabyte of physical memory space and 256 terabytes of virtual memory.

Note in the illustration that the CPU has a chamfer in one corner. This mark indicates the processor Pin A1 that should match a specific corner of the CPU socket.



2.4.2 Installing the CPU

Follow these steps to install a CPU.

1. Locate the 940-pin ZIF socket on the motherboard.

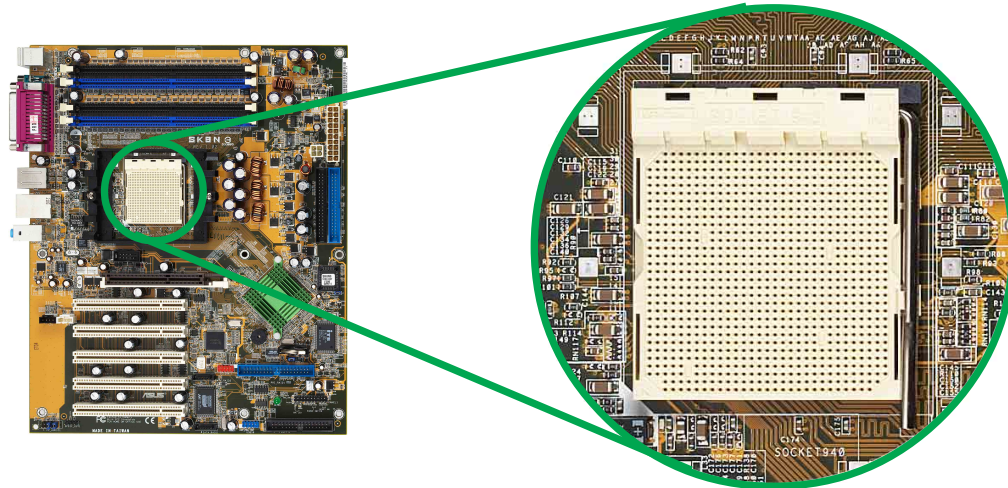

2. Unlock the socket by pressing the lever sideways, then lift it up to a 90°-100° angle.

Socket Lever

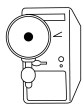

Make sure that the socket lever is lifted up to 90°-100° angle, otherwise the CPU does not fit in completely.



Incorrect installation of the CPU into the socket may bend the pins and severely damage the CPU!

3. Position the CPU above the socket such that its marked corner matches the base of the socket lever.
4. Carefully insert the CPU into the socket until it fits in place.



The CPU fits only in one correct orientation. **DO NOT** force the CPU into the socket to prevent bending the pins and damaging the CPU!

5. When the CPU is in place, push down the socket lever to secure the CPU. The lever clicks on the side tab to indicate that it is locked.

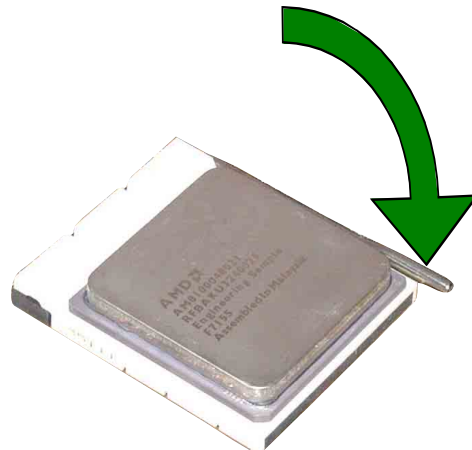

2.4.3 Installing the heatsink and fan

The AMD Opteron™ Processor requires a specially designed heatsink and fan assembly to ensure optimum thermal condition and performance.

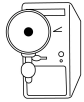

Make sure that you use only qualified heatsink and fan assembly.

Follow these steps to install the CPU heatsink and fan.

1. Place the heatsink on top of the installed CPU, making sure that the heatsink fits properly on the retention module base.



The retention module base is already installed on the motherboard upon purchase.

You do not have to remove the retention module base when installing the CPU or installing other motherboard components.

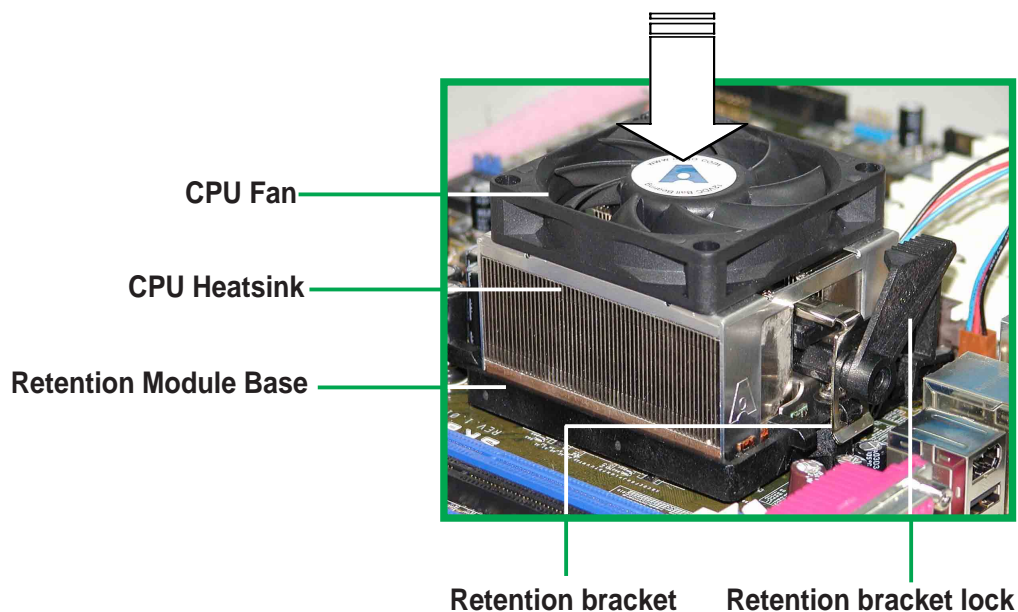

Your boxed CPU heatsink and fan assembly should come with installation instructions for the CPU, heatsink, and the retention mechanism. If the instructions in this section do not match the CPU documentation, follow the latter.

2. Attach one end of the retention bracket to the retention module base.

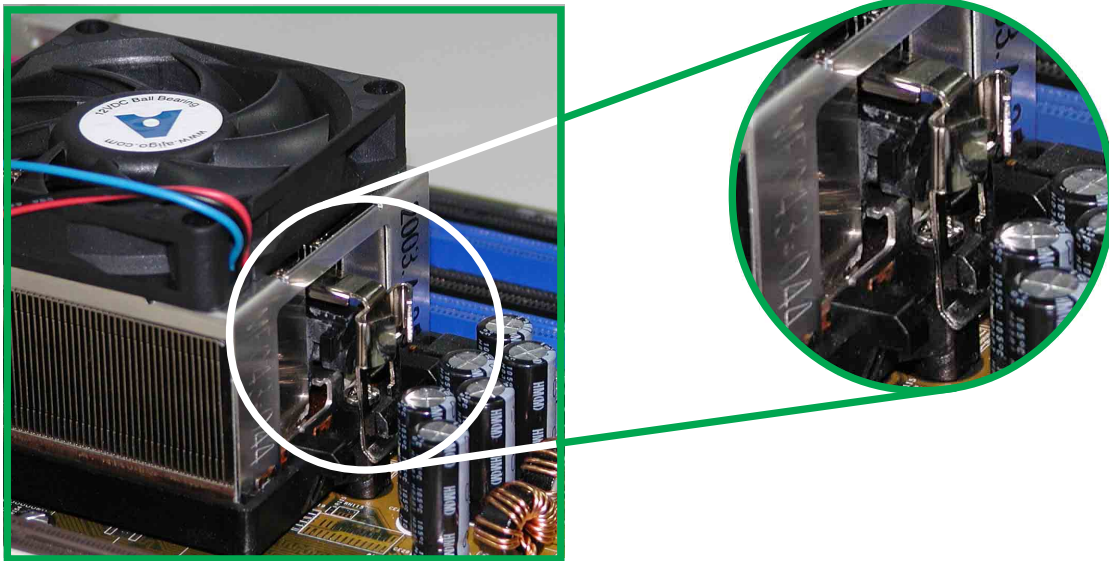

3. Align the other end of the retention bracket (near the retention bracket lock) to the retention module base. A clicking sound denotes that the retention bracket is in place.

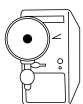
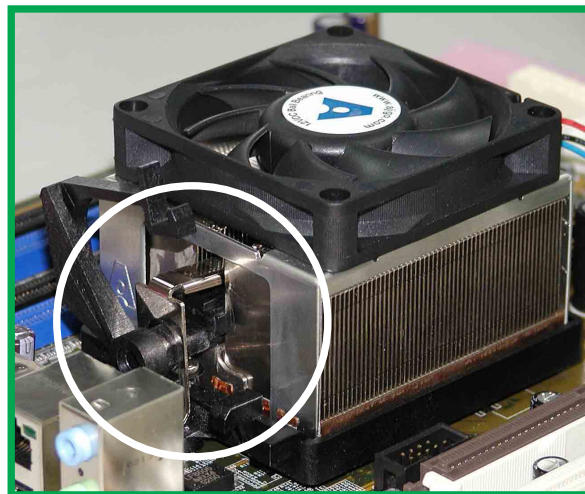

Make sure that the fan and heatsink assembly perfectly fits the retention mechanism module base, otherwise you cannot snap the retention bracket in place.

4. Push down the retention bracket lock on the retention mechanism to secure the heatsink and fan to the module base.

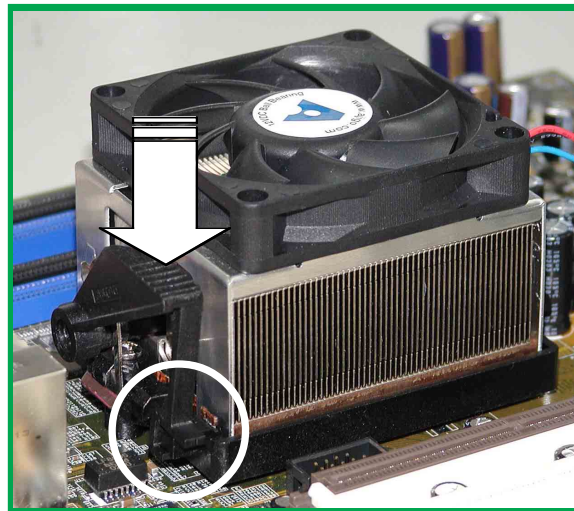

2.4.4 Connecting the CPU fan cable

When the fan, heatsink, and the retention mechanism are in place, connect the CPU fan cable to the connector on the motherboard labeled CPU_FAN1.

CPU Fan Connector
(CPU_FAN1)

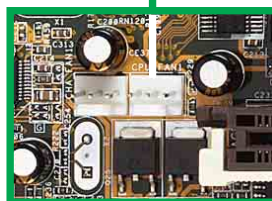

Don't forget to connect the CPU fan connector! Hardware monitoring errors may occur if you fail to plug this connector.

2.4.5 CPU Heatsink and Fan Qualified Vendor List

The following table lists the CPU heatsink and fan assembly that have been tested and qualified for use with this motherboard.

Vendor	Part Number	Performance
Thermaltake	A1724	0.31C/W
Foxconn	NBT-K5011NE1DBVCB-001	0.30C/W
Ajigo	MF043-044	0.30C/W

2.5 System memory

2.5.1 Overview

The motherboard comes with four Double Data Rate (DDR) Dual Inline Memory Module (DIMM) sockets. These sockets support up to 8GB system memory using 184-pin PC2700/PC2100/PC1600 ECC DDR registered DIMMs and allow up to 5.33 GB/s data transfer rate.

The following figure illustrates the location of the DDR DIMM sockets.

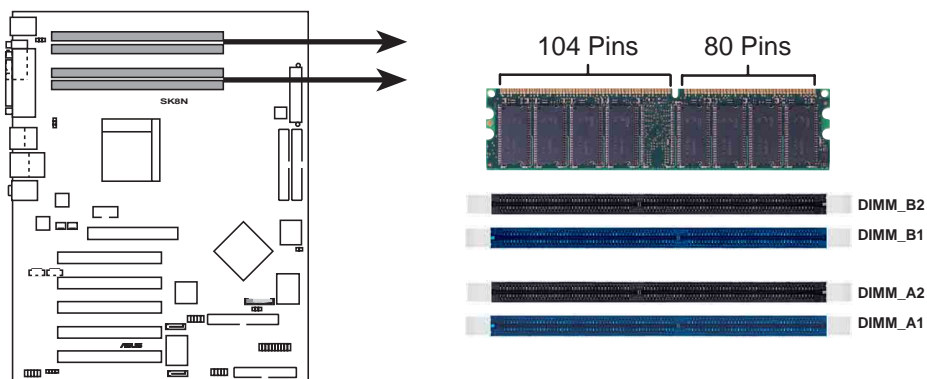

SK8N 184-Pin DDR DIMM Sockets

Notes on DDR technology

The DDR SDRAM technology evolved from the mainstream PC66, PC100, PC133 memory known as Single Data Rate (SDR) SDRAM. DDR memory however, has the ability to perform two data operations in one clock cycle, thus providing twice the throughput of SDR memory.

A DDR DIMM has the same physical dimensions as an SDR DIMM, but it has a 184-pin footprint compared to the 168-pin of the SDR DIMM. Also, a DDR DIMM is single notched while an SDR DIMM is double notched. Therefore, a DDR DIMM is not backward compatible with SDR, and should be installed only in a socket specially designed for DDR DIMMs.

2.5.2 Memory configurations

You may install 64MB, 128MB, 256MB, 512MB, 1GB and 2GB DDR DIMMs into the DIMM sockets using the memory configurations in this section.

Important notes on memory configurations



1. Installing DDR DIMMs other than the recommended configurations may cause memory sizing error or system boot failure. Use any of the recommended configurations in Table 1.
2. In Dual-channel configurations, install only identical (the same type and size) DDR DIMM pairs for each channel.
3. Always install DIMMs with the same CAS latency. For optimum compatibility, it is recommended that you obtain memory modules from the same vendor. See list of Qualified Vendors List on page 2-13.
4. When all four sockets are populated with 1GB DIMMs (total 4GB), the system may detect only 3+GB (a little less than 4GB) due to the Northbridge resource allocation.
5. It is recommended to use the black DIMM slots first.

Table 1 Recommended memory configurations

Mode	Sockets			
	DIMM_A1	DIMM_A2	DIMM_B1	DIMM_B2
Single-channel	(1) —	Populated	—	—
	(2) Populated	—	—	—
	(3) Populated	Populated	—	—
Dual-channel*	(1) —	Populated	—	Populated
	(2) Populated	—	Populated	—
	(3) Populated	Populated	Populated	Populated

* Use only identical DDR DIMM pairs.

* For dual-channel configuration (3), you may:

- install identical DIMMs in all four sockets

or

- install identical DIMM pair in DIMM_A1 and DIMM_B1 (blue sockets) and identical DIMM pair in DIMM_A2 and DIMM_B2 (black sockets)

2.5.2.1 DDR Qualified Vendor List

The following table lists the PC2700 (DDR333) memory modules that have been tested and qualified for use with this motherboard.

Size	Vendor	Model	Brand	SS/DS	Component	A*	B*	C*
256MB	Apacer	77.10632.112	Infineon	SS	HYB25D256800BT-6B	•	•	•
512MB	Apacer	77.10732.112	Infineon	DS	HYB25D256800BT-6B	•	•	
512MB	Apacer	78.91052.111	Infineon	DS	HYB25D256800BT-6B	•	•	•
256MB	ATP	AB32L72Q8SQB3S	SAMSUNG	SS	K4H560838D-TCB3	•	•	•
512MB	ATP	AB64L72Q8S8B3S	SAMSUNG	DS	K4H560838D-TCB3	•	•	•
1024MB	ATP	AB28L72P4SMB3C	Infineon	DS	HYB25D256400BT	•	•	•
512MB	CORSAIR	CM72SD512RLP-2700/S	SAMSUNG	DS	K4H560838D-TCB3	•	•	
1024MB	CORSAIR	CM74SD1024RLP-2700/S	SAMSUNG	DS	K4H560438D-TCB3	•	•	•
512MB	SAMSUNG	CM72SD512RLP-2700/S	SAMSUNG	DS	K4H560838D-TCB3	•	•	•
1024MB	SAMSUNG	M312L282DG0-CB3	SAMSUNG		K4H560438D-GCB3	•	•	

- A*** - supports one module inserted in any slot in a Single-channel memory configuration.
- B*** - supports one pair of modules inserted into either the blue slots or the black slots as one pair of Dual-channel memory configuration .
- C*** - support for 4 modules inserted into the blue and black slots as two pairs of Dual-channel memory configuration.



Visit the ASUS website (www.asus.com) for the latest qualified vendor DDR333 module list for this motherboard.

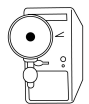

Obtain DDR DIMMs only from ASUS qualified vendors for better system performance.

2.5.3 Installing a DIMM



Make sure to unplug the power supply before adding or removing DIMMs or other system components. Failure to do so may cause severe damage to both the motherboard and the components.

Follow these steps to install a DIMM.

1. Locate the DIMM sockets in the motherboard.

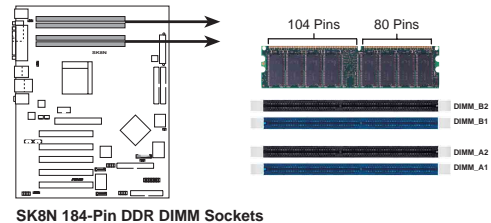

SK8N 184-Pin DDR DIMM Sockets

2. Unlock a DIMM socket by pressing the retaining clips outward.
3. Align a DIMM on the socket such that the notch on the DIMM matches the break on the socket.

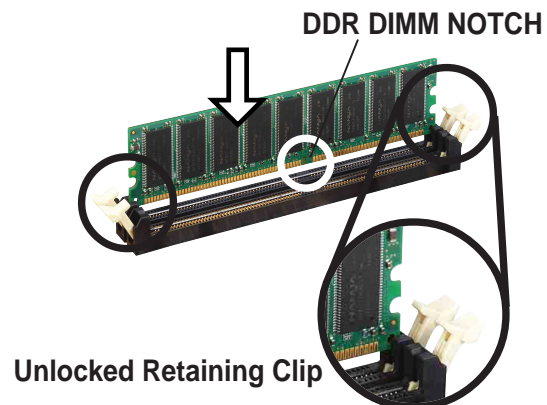

A DDR DIMM is keyed with a notch so that it fits in only one direction. **DO NOT** force a DIMM into a socket to avoid damaging the DIMM.

4. Firmly insert the DIMM into the socket until the retaining clips snap back in place and the DIMM is properly seated.

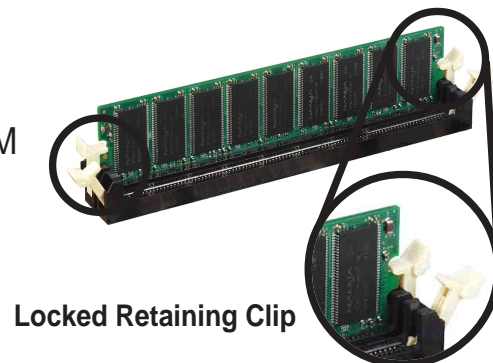

2.5.4 Removing a DIMM

Follow these steps to remove a DIMM.

1. Simultaneously press the retaining clips outward to unlock the DIMM.

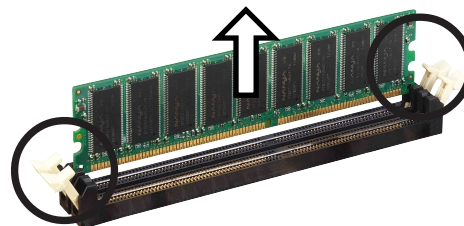

Support the DIMM lightly with your fingers when pressing the retaining clips. The DIMM might get damaged when it flips out with extra force.

2. Remove the DIMM from the socket.

2.6 Expansion slots

In the future, you may need to install expansion cards. The motherboard has five PCI slots and one Accelerated Graphics Port (AGP) slot. The following sub-sections describe the slots and the expansion cards that they support.



Make sure to unplug the power cord before adding or removing expansion cards. Failure to do so may cause you physical injury and damage motherboard components.

2.6.1 Installing an expansion card

Follow these steps to install an expansion card.

1. Before installing the expansion card, read the documentation that came with it and make the necessary hardware settings for the card.
2. Remove the system unit cover (if your motherboard is already installed in a chassis).
3. Remove the bracket opposite the slot that you intend to use. Keep the screw for later use.
4. Align the card connector with the slot and press firmly until the card is completely seated on the slot.
5. Secure the card to the chassis with the screw you removed earlier.
6. Replace the system cover.

2.5.2 Configuring an expansion card

After installing the expansion card, configure the card by adjusting the software settings.

1. Turn on the system and change the necessary BIOS settings, if any. See Chapter 4 for information on BIOS setup.
2. Assign an IRQ to the card. Refer to the tables on the next page.
3. Install the software drivers for the expansion card.

Standard Interrupt Assignments

IRQ	Priority	Standard Function
0	1	System Timer
1	2	Keyboard Controller
2	N/A	Programmable Interrupt
3*	11	Communications Port (COM2)
4*	12	Communications Port (COM1)
5*	13	Sound Card (sometimes LPT2)
6	14	Floppy Disk Controller
7*	15	Printer Port (LPT1)
8	3	System CMOS/Real Time Clock
9*	4	ACPI Mode when used
10*	5	IRQ Holder for PCI Steering
11*	6	IRQ Holder for PCI Steering
12*	7	PS/2 Compatible Mouse Port
13	8	Numeric Data Processor
14*	9	Primary IDE Channel
15*	10	Secondary IDE Channel

* These IRQs are usually available for ISA or PCI devices.

IRQ assignments for this motherboard

	PCI INT A	PCI INT B	PCI INT C	PCI INT D
PCI slot 1	INT A	INT B	INT C	INT D
PCI slot 2	INT B	INT C	INT D	INT A
PCI slot 3	INT C	INT D	INT A	INT B
PCI slot 4	INT D	INT A	INT B	INT C
PCI slot 5	INT A	INT B	INT C	INT D
AGP slot	INT E	INT D	—	—
Onboard RAID	INT C	—	—	—
Onboard 1394	INT D	—	—	—

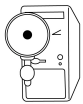

When using PCI cards on shared slots, ensure that the drivers support “Share IRQ” or that the cards do not need IRQ assignments. Otherwise, conflicts will arise between the two PCI groups, making the system unstable and the card inoperable.

2.6.3 PCI slots

There are five 32-bit PCI slots on this motherboard. The slots support PCI cards such as a LAN card, SCSI card, USB card, and other cards that comply with PCI specifications. The following figure shows a LAN card installed on a PCI slot.



2.6.4 AGP slot

This motherboard has an Accelerated Graphics Port (AGP) slot that only supports +1.5V AGP cards. When you buy an AGP card, make sure that you ask for one with +1.5V specification. Note the notches on the card golden fingers to ensure that they fit the AGP slot on your motherboard.



Install only 1.5V AGP cards on this motherboard! 3.3V AGP cards are not supported in this motherboard.

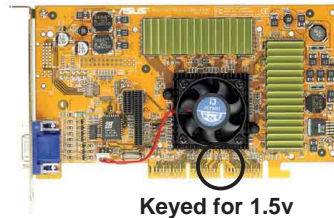
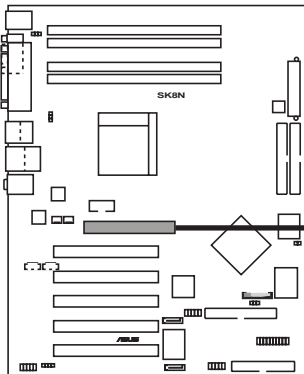

SK8N Accelerated Graphics Port (AGP)

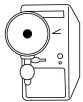

If installing the ATi 9500 or 9700 Pro Series VGA cards, use only the card version **PN xxx-xxxx-30** or later, for optimum performance and overclocking stability.



2.7 Jumpers

1. Clear RTC RAM (CLRTC1)

This jumper allows you to clear the Real Time Clock (RTC) RAM in CMOS. You can clear the CMOS memory of date, time, and system setup parameters by erasing the CMOS RTC RAM data. The RAM data in CMOS, that include system setup information such as system passwords, is powered by the onboard button cell battery.

To erase the RTC RAM:

1. Turn OFF the computer and unplug the power cord.
2. Remove the onboard battery.
3. Place a jumper cap to pins 2-3. Keep the cap on pins 2-3 for about 5~10 seconds, then remove the cap.
4. Replace the battery.
5. Plug the power cord and turn ON the computer.
6. Hold down the key during the boot process and enter BIOS setup to re-enter data.

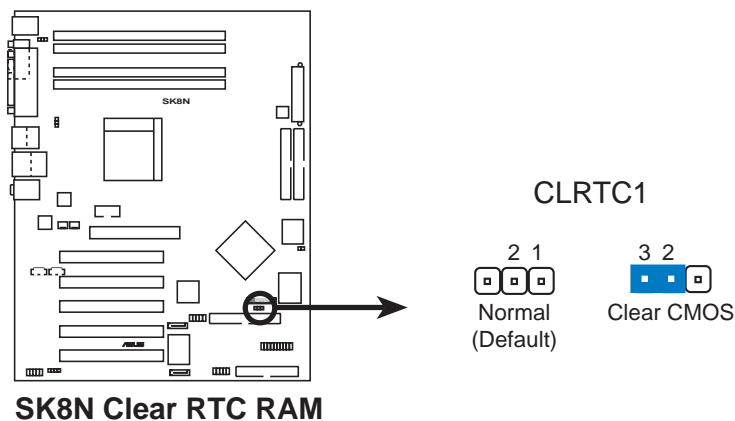

2. Boot Block Write Protect (2- pin J1)

This jumper allows you to enable or disable the boot block write protect feature. Remove the jumper cap to enable the boot block write protect feature (the default setting is disabled).

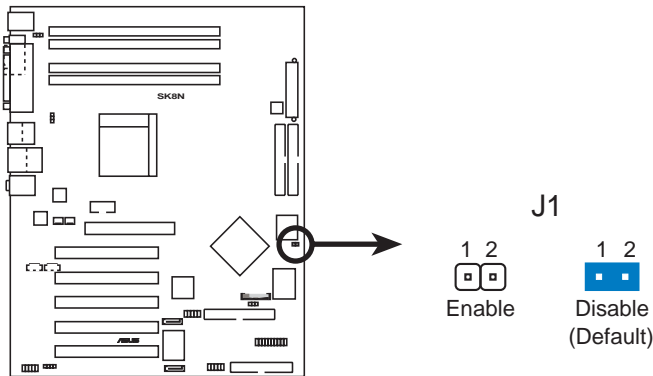

SK8N Boot Block Write Protect

3. USB device wake-up (3-pin USBPW1234)

Set these jumpers to +5V to wake up the computer from S1 sleep mode (CPU stopped, DRAM refreshed, system running in low power mode) using the connected USB devices. Set to +5VSB to wake up from S3 and S4 sleep modes (no power to CPU, DRAM in slow refresh, power supply in reduced power mode).

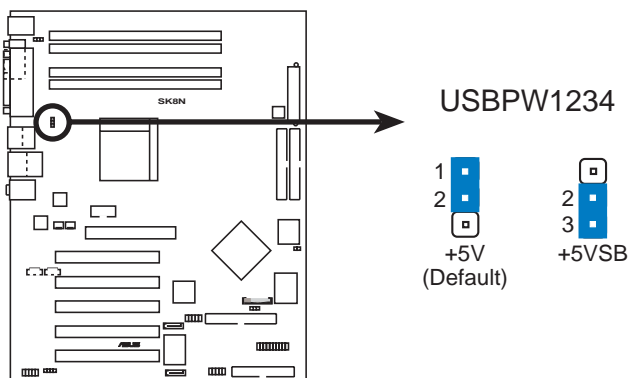

SK8N USB Device Wake Up

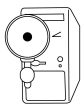

- The USB device wake-up feature requires a power supply that can provide 500mA on the +5VSB lead for each USB port. Otherwise, the system would not power up.
- The total current consumed must NOT exceed the power supply capability (+5VSB) whether under normal condition or in sleep mode.

2.8 Connectors

This section describes and illustrates the internal connectors on the motherboard.

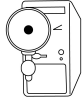

Always connect ribbon cables with the colored to Pin 1 on the connectors. Pin 1 is usually on the side closest to the power connector on hard drives and CD-ROM drives, but may be on the opposite side on floppy disk drives.

1. Floppy disk drive connector (34-1 pin FLOPPY1)

This connector supports the provided floppy drive ribbon cable. After connecting one end to the motherboard, connect the other end to the floppy drive. (Pin 5 is removed to prevent incorrect insertion when using ribbon cables with pin 5 plug).

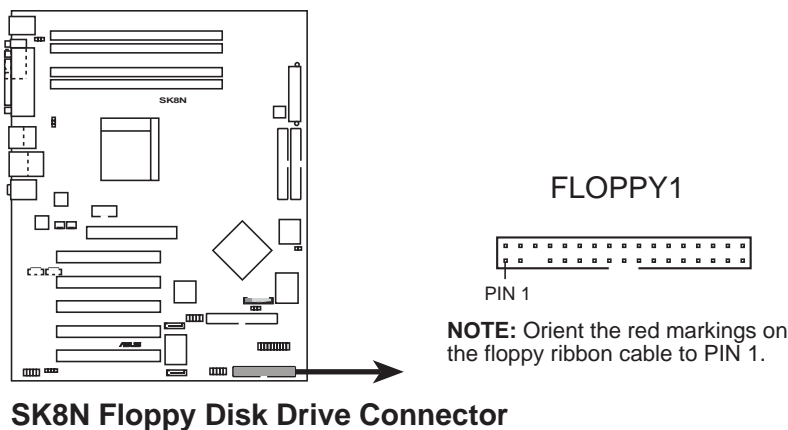

SK8N Floppy Disk Drive Connector

2. IDE connectors (40-1 pin PRI_IDE, SEC_IDE)

This connector supports the provided UltraDMA133/100/66 IDE hard disk ribbon cable. Connect the cable's blue connector to the primary (recommended) or secondary IDE connector, then connect the gray connector to the UltraDMA133/100/66 slave device (hard disk drive) and the black connector to the UltraDMA133/100/66 master device. It is recommended that you connect non-UltraDMA133/100/66 devices to the secondary IDE connector. If you install two hard disks, you must configure the second drive as a slave device by setting its jumper accordingly. Refer to the hard disk documentation for the jumper settings. BIOS supports specific device bootup. If you have more than two UltraDMA133/100/66 devices, purchase another UltraDMA133/100/66 cable. You may configure two hard disks to be both master devices with two ribbon cables – one for the primary IDE connector and another for the secondary IDE connector.

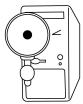

- Pin 20 on each IDE connector is removed to match the covered hole on the UltraDMA cable connector. This prevents incorrect orientation when you connect the cables.
- The hole near the blue connector on the UltraDMA100/66 cable is intentional.

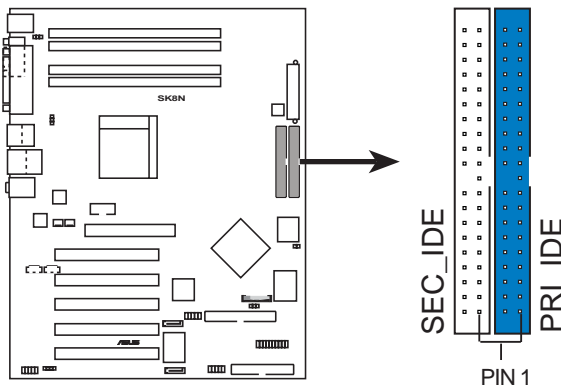

SK8N IDE Connectors

NOTE: Orient the red markings (usually zigzag) on the IDE ribbon cable to PIN 1.

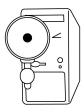

For UltraDMA133/100/66 IDE devices, use an 80-conductor IDE cable. The UltraDMA/66 cable included in the motherboard package also supports UltraDMA133 or UltraDMA100.

3. Serial ATA connectors (7-pin SATA_RAID1, SATA_RAID2)

These next generation connectors support the thin Serial ATA cables for primary internal storage devices. The current Serial ATA interface allows up to 150 MB/s data transfer rate, faster than the standard parallel ATA with 133 MB/s (UltraDMA133).

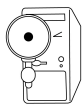
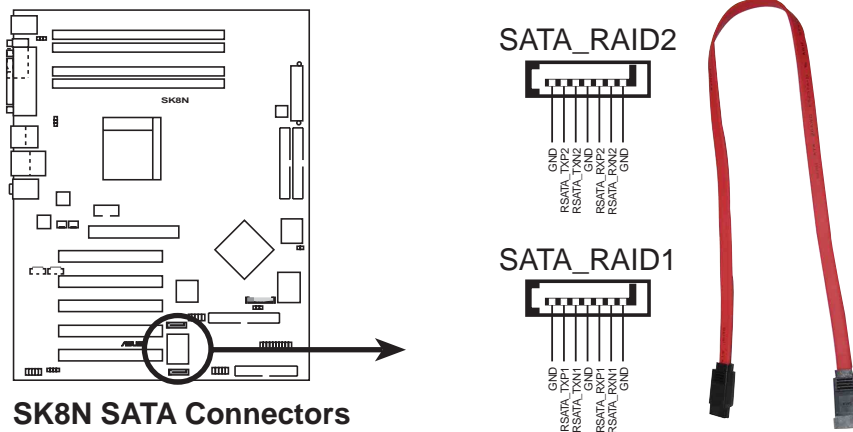

Important notes on Serial ATA solution:

- The Serial ATA cable is smaller and more flexible allowing easier routing inside the chassis. The lower pin count of the Serial ATA cable eliminates the problem caused by the wide, flat ribbon cables of the Parallel ATA interface.
- Hot plug support for Serial ATA drive and connections are not available in this motherboard.
- Install Windows® XP™ Service Pack 1 when using Serial ATA.

4. RAID ATA/133/100/66/33 connector (40-1 pin PRI_RAID1)

This connector support either RAID 0, RAID 1 or RAID 0 + 1 configuration with the Serial ATA connectors through the onboard Promise® PDC20378 controller. You can use the RAID feature to set up a disk array configuration and to support additional IDE devices.

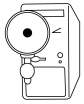
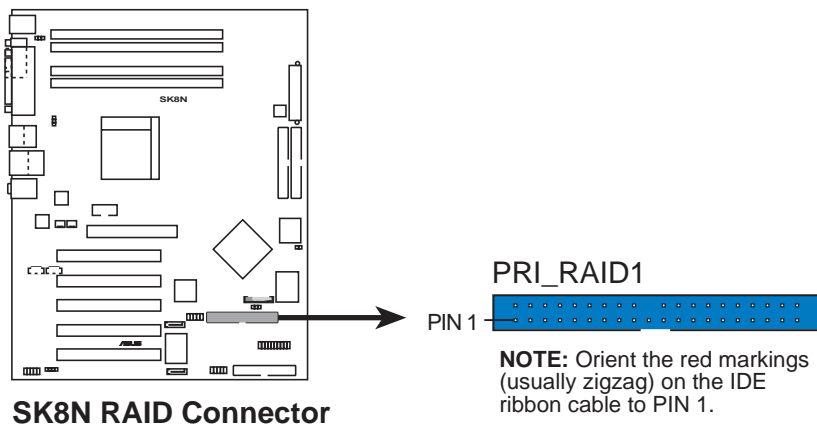

Important notes on the RAID feature:

- By default, the drive that you connect to the PRI_RAID connector follow the ATA133/100/66/33 protocol as an independent drive, not as a disk array.
 - The RAID/SATA controller chipset does not support ATAPI devices such as CD-ROMs, DVD-ROMs, etc.
 - RAID feature only supported in Microsoft Operating Systems.
-

5. CPU, Power and Chassis Fan Connectors (3-pin CPU_FAN1, CHA_FAN1, PWR_FAN1)

The fan connectors support cooling fans of 350mA~740mA (8.88W max.) or a total of 1A~2.22A (26.64W max.) at +12V. Connect the fan cables to the fan connectors on the motherboard, making sure that the black wire of each cable matches the ground pin of the connector.



Do not forget to connect the fan cables to the fan connectors. Lack of sufficient air flow within the system may damage the motherboard components. These are not jumpers! **DO NOT** place jumper caps on the fan connectors!

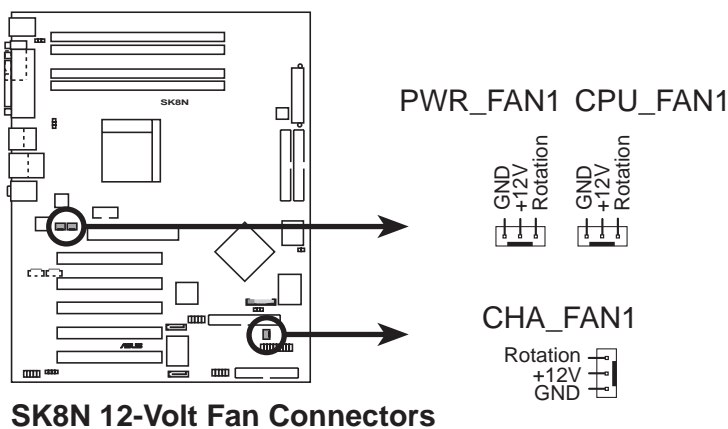

6. Serial Port 2 connector (10-1 pin COM2)

This connector accommodates a second serial port using a serial port bracket. Connect the bracket cable to this connector then install the bracket into a slot opening at the back of the system chassis.

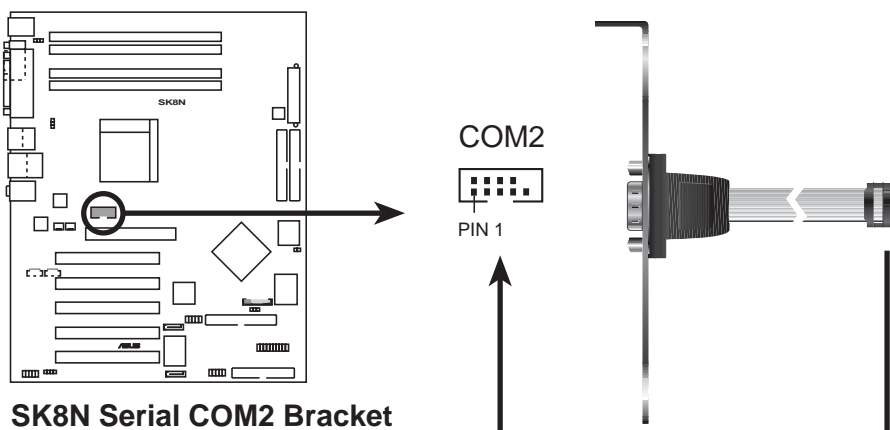

7. ATX power connectors (20-pin ATXPWR, 4-pin ATX12V)

These connectors connect to an ATX 12V power supply. The plugs from the power supply are designed to fit these connectors in only one orientation. Find the proper orientation and push down firmly until the connectors completely fit.

In addition to the 20-pin ATXPWR1 connector, this motherboard requires that you connect the 4-pin ATX +12V power plug to provide sufficient power to the CPU.

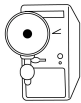

- Do not forget to connect the 4-pin ATX +12V power plug. Otherwise, the system does not boot up.
- Make sure that your ATX 12V power supply can provide 8A on the +12V lead and at least 1A on the +5-volt standby lead (+5VSB). The minimum recommended wattage is 230W, or 300W for a fully configured system. The system may become unstable or may not boot up if the power is inadequate.

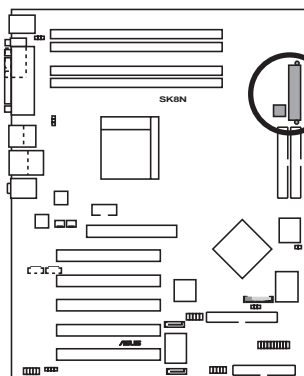

SK8N ATX Power Connector

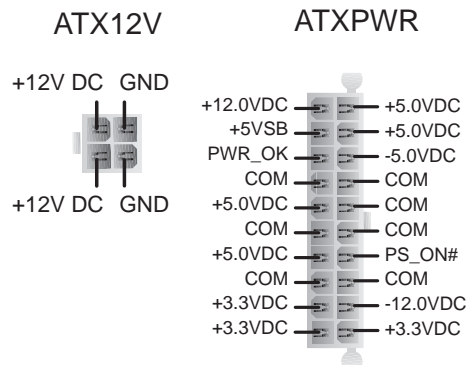

8. USB headers (10-1 pin USB_56)

If the USB ports on the rear panel are inadequate, a USB header is available for additional USB ports. The USB header complies with USB 2.0 specification that supports up to 480 Mbps connection speed. This speed advantage over the conventional 12 Mbps on USB 1.1 allows faster Internet connection, interactive gaming, and simultaneous running of high-speed peripherals.

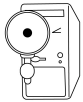

You must install the driver before you can use the USB 2.0 capability.

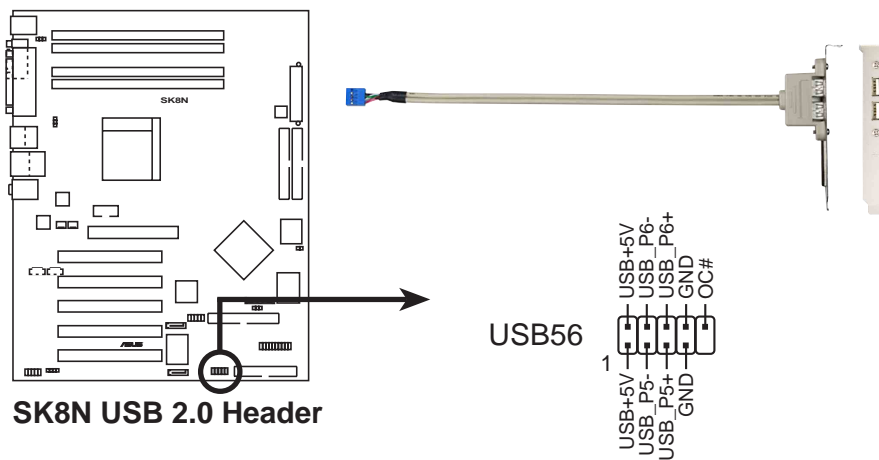

NEVER connect a **1394 cable** to the USB_56 connector. Doing so will damage the motherboard!

9. Internal audio connectors (4-pin CD1, AUX1)

These connectors allow you to receive stereo audio input from sound sources such as a CD-ROM, TV tuner, or MPEG card.

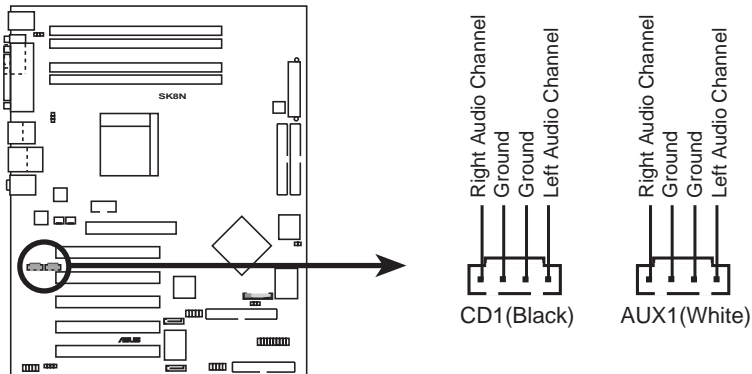

SK8N Internal Audio Connectors

10. IEEE 1394 connectors (10-1 pin IE1394_1(Orange))

These connectors are for IEEE 1394 modules. Attach the 10-1 pin cable plugs to these connectors. You may also connect a 1394-compliant internal hard disk to these connectors.

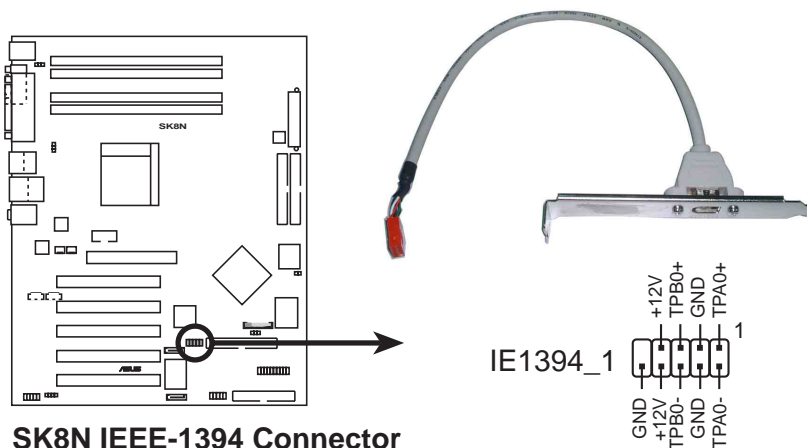

SK8N IEEE-1394 Connector



NEVER connect a **USB cable** to any of the IEEE 1394 (orange) connectors. Doing so will damage the motherboard!

11. Front panel audio connector (10-1 pin FP_AUDIO)

This is an interface for the Intel front panel audio cable that allow convenient connection and control of audio devices.

By default, the pins labeled LINE_OUT_R/BLINE_OUT_R and the pins LINE_OUT_L/BLINE_OUT_L are shorted with jumper caps. Remove the caps only when you are connecting the front panel audio cable.

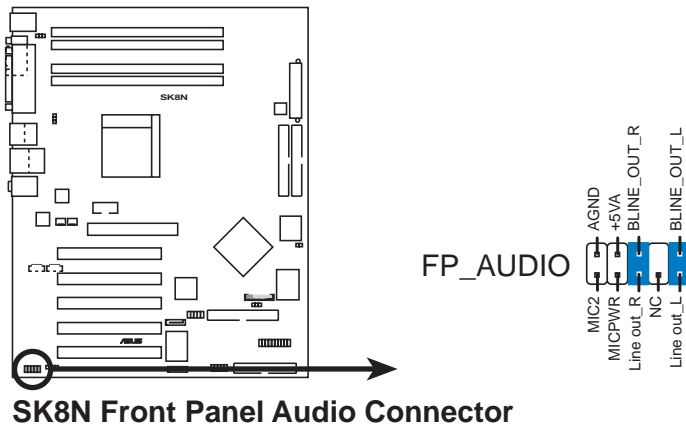

12. Digital Audio connector (6-1 pin SPDIF_OUT)

This connector is for the S/PDIF audio module to allow digital sound output. Connect one end of the S/PDIF audio cable to this connector and the other end to the S/PDIF module.

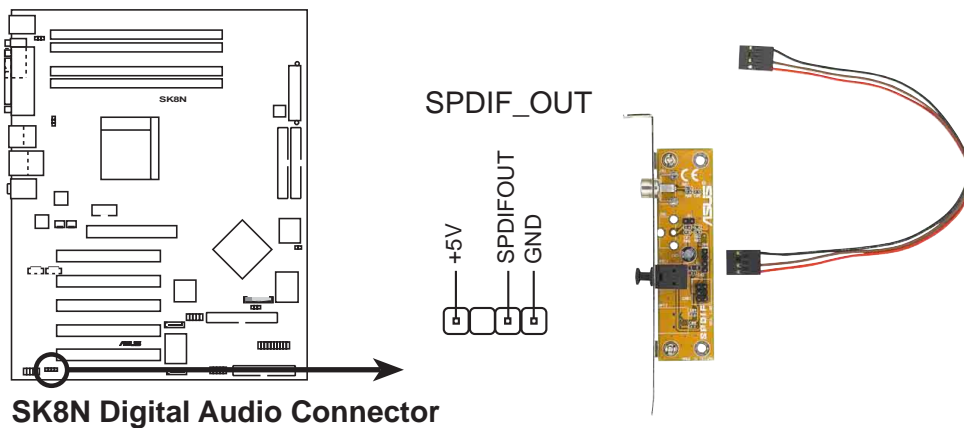

13. System panel connector (20-pin PANEL)

This connector accommodates several system front panel functions.

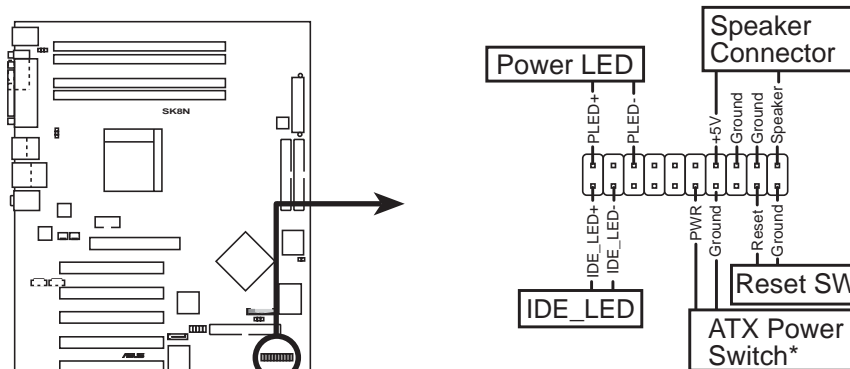

SK8N System Panel Connectors

* Requires an ATX power supply.

- **System Power LED Lead (3-1 pin PLED)**

This 3-1 pin connector connects to the system power LED. The LED lights up when you turn on the system power, and blinks when the system is in sleep mode.

- **System Warning Speaker Lead (4-pin SPKR)**

This 4-pin connector connects to the case-mounted speaker and allows you to hear system beeps and warnings.

- **ATX Power Switch / Soft-Off Switch Lead (2-pin PWRBTN)**

This connector connects a switch that controls the system power. Pressing the power switch turns the system between ON and SLEEP, or ON and SOFT OFF, depending on the BIOS or OS settings. Pressing the power switch while in the ON mode for more than 4 seconds turns the system OFF.

- **Reset Switch Lead (2-pin RESET)**

This 2-pin connector connects to the case-mounted reset switch for rebooting the system without turning off the system power.

- **Hard disk activity LED (2-pin IDE_LED)**

This connector supplies power to the hard disk activity LED. Any read or write activity of an IDE device cause this LED to light up.

Chapter 3

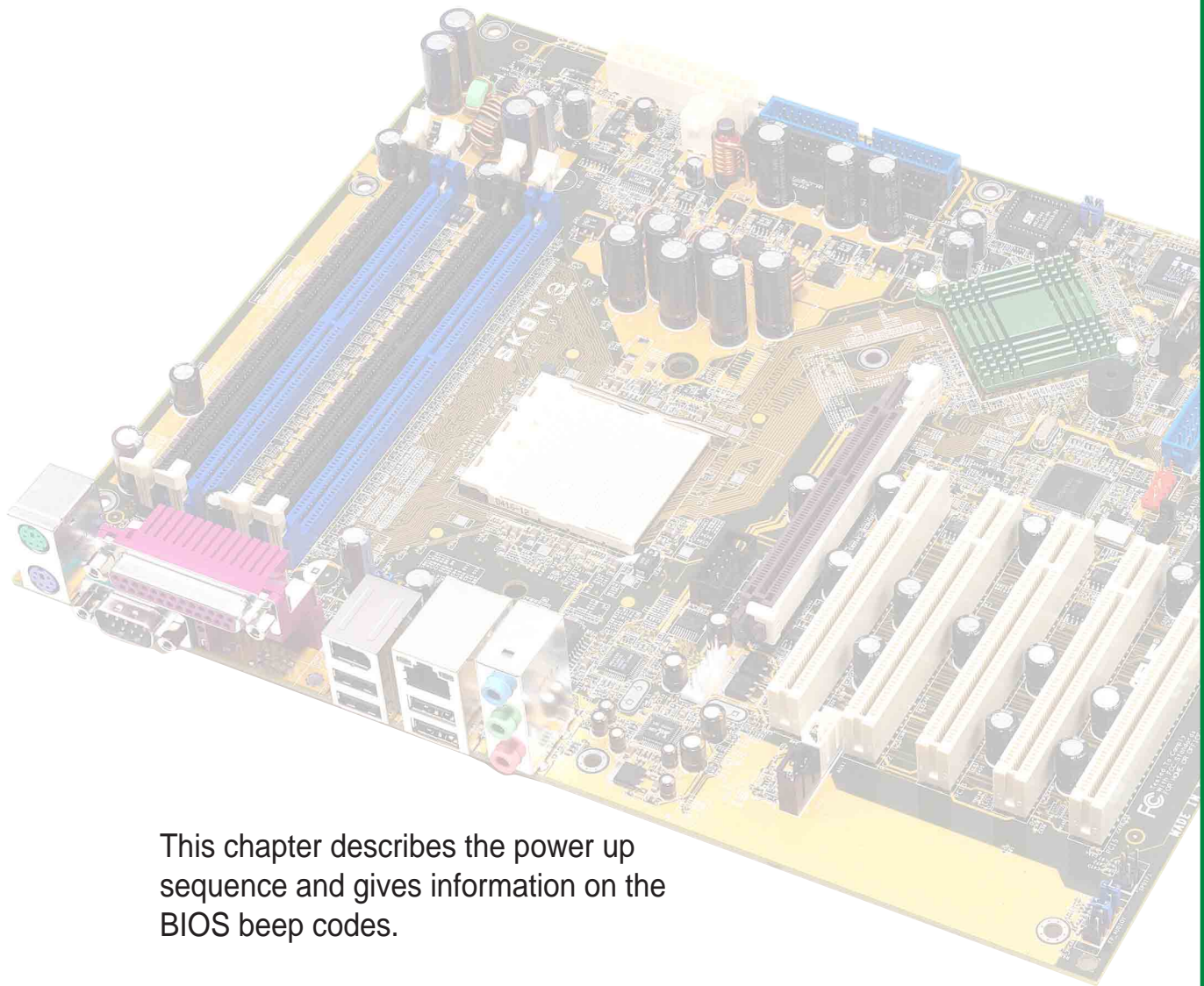

This chapter describes the power up sequence and gives information on the BIOS beep codes.

Powering up

Chapter summary

- 3.1 Starting up for the first time 3-1**
- 3.2 Powering off the computer 3-2**

3.1 Starting up for the first time

1. After making all the connections, replace the system case cover.
2. Be sure that all switches are off.
3. Connect the power cord to the power connector at the back of the system chassis.
4. Connect the power cord to a power outlet that is equipped with a surge protector.
5. Turn on the devices in the following order:
 - a. Monitor
 - b. External SCSI devices (starting with the last device on the chain)
 - c. System power (if you are using an ATX power supply, you need to switch on the power supply as well as press the ATX power switch on the front of the chassis).
6. After applying power, the power LED on the system front panel case lights up. For ATX power supplies, the system LED lights up when you press the ATX power switch. If your monitor complies with “green” standards or if it has a “power standby” feature, the monitor LED may light up or switch between orange and green after the system LED turns on. The system then runs the power-on tests. While the tests are running, the BIOS beeps or additional messages appear on the screen. If you do not see anything within 30 seconds from the time you turned on the power, the system may have failed a power-on test. Check the jumper settings and connections or call your retailer for assistance.
7. At power on, hold down <Delete> to enter BIOS Setup. Follow the instructions in Chapter 4.

3.2 Powering off the computer

Using the OS shut down function

If you use Windows 2000/XP, click the **Start** button, click **Shut Down**, then the **OK** button to shut down the computer. The power supply should turn off after Windows shuts down.

Using the dual function power switch

While the system is ON, pressing the power switch for less than 4 seconds puts the system to sleep mode or to soft-off mode, depending on the BIOS setting. Pressing the power switch for more than 4 seconds lets the system enter the soft-off mode regardless of the BIOS setting. See section “4.5 Power Menu” in Chapter 4.

Chapter 4

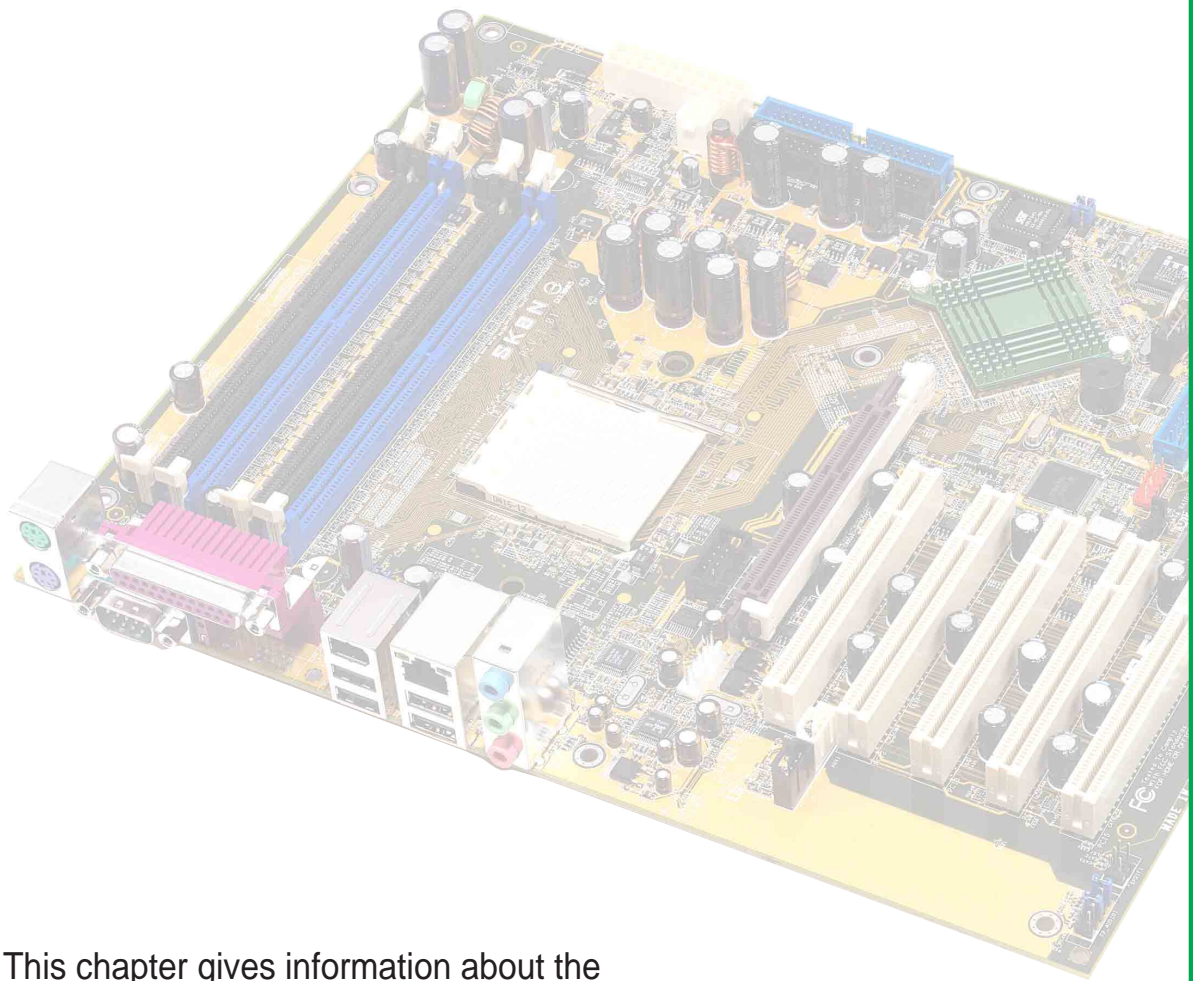

This chapter gives information about the ASUS SK8N Basic Input/Output System (BIOS). This chapter includes updating the BIOS using the AFUDOS.EXE utility that is bundled with the support CD.

BIOS setup

Chapter summary

4.1	Managing and updating your BIOS	4-1
4.2	BIOS Setup program	4-7
4.3	Main Menu	4-10
4.4	Advanced Menu	4-13
4.5	Power Menu	4-25
4.6	Boot Menu	4-29
4.7	Exit Menu	4-34

4.1 Managing and updating your BIOS

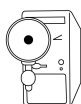

-
- The **original BIOS file** for this motherboard is in the root directory of the support CD filenamed “SK8N.ROM”.
 - Copy the original BIOS to a **bootable floppy disk** in case you need to restore the BIOS in the future.
-

4.1.1 Creating a bootable floppy disk

1. Do either one of the following to create a bootable floppy disk.

DOS environment

Insert a 1.44 MB floppy disk into the drive. At the DOS prompt, type:

format A:/S , then press the <Enter> key

Windows environment

- a. From your Windows desktop, click on **Start**, point to **Settings**, then click on **Control Panel**.
 - b. Double-click on **Add/Remove Programs** icon from the Control Panel window.
 - c. Click on the **Startup Disk** tab, then on **Create Disk...** button.
 - d. Insert a 1.44 MB floppy disk when prompted. Follow the succeeding screen instructions to complete the process.
2. Copy the original (or the latest) motherboard BIOS to the bootable floppy disk.

4.1.2 Using AFUDOS to update the BIOS

Update the BIOS using the AFUDOS.EXE utility in DOS environment.

1. Visit the ASUS website (www.asus.com) to download the latest BIOS file for your motherboard. Save the BIOS file to a bootable floppy disk.



Write down the BIOS file name to a piece of paper. You need to type the **exact BIOS file name** at the prompt.

2. Copy the AFUDOS.EXE utility from the support CD to the bootable floppy disk that contains the BIOS file.
3. Boot the system from the floppy disk.

4. At the DOS prompt, type the command line:

afudos /i<filename>

where “filename” means the latest (or original) BIOS file that you copied to the bootable floppy disk.

The screen displays the status of the update process.



The BIOS information on the screen is for reference only. What you see on your screen may not be exactly the same as shown.

```
A:\>afudos /iSK8N.rom
AMI Firmware Update Utility - Version 1.10
Copyright (C) 2002 American Megatrends, Inc. All rights reserved.

Reading file ..... done
Erasing flash .... done
Writing flash .... 0x0008CC00 (9%)
```



DO NOT shutdown or reset the system while updating the BIOS! Doing so may cause system boot failure!

When the BIOS update process is complete, the utility returns to the DOS prompt.

```
A:\>afudos /iSK8N.rom
AMI Firmware Update Utility - Version 1.10
Copyright (C) 2002 American Megatrends, Inc. All rights reserved.

Reading file ..... done
Erasing flash .... done
Writing flash .... 0x0008CC00 (9%)
Verifying flash .. done

A:\>
```

5. Reboot the system.

4.1.3 Using AFUDOS to copy BIOS from PC

The AFUDOS.EXE utility can also be used to copy the current system BIOS settings to a floppy or hard disk. The copy can be used as a backup in case the system BIOS fails or gets corrupted.

1. At the DOS prompt, type the command line:

afudos /o<filename>

where “filename” can be any user provided filename of not more than eight (8) alpha-numeric characters for the main filename and three (3) alpha-numeric characters for the extension name.

Press the **Enter** key.



The BIOS information on the screen is for reference only. What you see on your screen may not be exactly the same as shown.

```
A:\>afudos /oMYBIOS03.rom
AMI Firmware Update Utility - Version 1.10
Copyright (C) 2002 American Megatrends, Inc. All rights reserved.

Reading flash ..... 0x0008CC00 (9%)
```

2. The utility will copy the current system BIOS by default to the floppy disk. Make sure that the floppy disk is not write-protected and have enough space (at least 600KB) to store the file.

```
A:\>afudos /oMYBIOS03.rom
AMI Firmware Update Utility - Version 1.10
Copyright (C) 2002 American Megatrends, Inc. All rights reserved.

Reading flash ..... done

A:\>
```

When the BIOS copy process is complete, the utility returns to the DOS prompt.

4.1.4 Using ASUS EZ Flash to update the BIOS

The ASUS EZ Flash feature allows you to easily update the BIOS without having to go through the long process of booting from a diskette and using a DOS-based utility. The EZ Flash is built-in the BIOS firmware so it is accessible by simply pressing <Alt> + <F2> during the Power-On Self Tests (POST).

To update the BIOS using ASUS EZ Flash:

1. Visit the ASUS website (www.asus.com) to download the latest BIOS file for your motherboard. Save the BIOS file to a floppy disk.
2. Reboot the system.
3. To launch EZ Flash, press <Alt> + <F2> during POST to display the following.

```
User recovery requested. Starting BIOS recovery...
Checking for floppy...
```



- If there is no floppy disk found in the drive, the error message “**Floppy not found!**” appears.
- If the correct BIOS file is not found in the floppy disk, the error message “**SK8N.ROM not found!**” is displayed.

4. Insert the floppy disk that contains the BIOS file. If all the necessary files are found in the floppy disk, EZ Flash performs the BIOS update process and automatically reboots the system when done.



DO NOT shutdown or reset the system while updating the BIOS! Doing so may cause system boot failure!

```
User recovery requested. Starting BIOS recovery...
Checking for floppy...
Floppy found!
Reading file "SK8N.rom". Completed.
Start flashing...
Flashed successfully. Rebooting.
```

4.1.5 Recovering the BIOS with CrashFree BIOS 2

The CrashFree BIOS 2 auto recovery tool allows you to restore BIOS from the motherboard support CD, or from a floppy disk that contains the BIOS file, in case the current BIOS on the motherboard fails or gets corrupted.

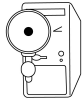

- Prepare the **support CD** that came with the motherboard or a **floppy disk that contains the motherboard BIOS** before proceeding with the BIOS update process.
- If you have saved a copy of the original motherboard BIOS to a bootable floppy disk, you may also use this disk to restore the BIOS. See section “4.1.1 Creating a bootable floppy disk.”
- Make sure that the BIOS filename is “SK8N.ROM”.

To recover the BIOS from a floppy disk:

1. Boot the system.
2. When a corrupted BIOS is detected, the following screen message appears.

```
Bad BIOS checksum. Starting BIOS recovery...
Checking for floppy...
```

3. Insert a floppy disk that contains the original or the latest BIOS file for this motherboard. If all the necessary files are found in the floppy disk, the BIOS update process continues.

```
Bad BIOS checksum. Starting BIOS recovery...
Checking for floppy...
Floppy found!
Reading file "SK8N.rom". Completed.
Start flashing...
```



DO NOT shutdown or reset the system while updating the BIOS! Doing so may cause system boot failure!

4. When the BIOS update process is complete, reboot the system.

To recover the BIOS from the support CD:

1. Boot the system.
2. When a corrupted BIOS is detected, the following screen message appears.

```
Bad BIOS checksum. Starting BIOS recovery...  
Checking for floppy...
```



If there is no floppy disk found in the drive, the system automatically checks the CD-ROM.

3. Place the support CD in the CD-ROM. The support CD contains the original BIOS for this motherboard.

```
Bad BIOS checksum. Starting BIOS recovery...  
Checking for floppy...  
Floppy not found!  
Checking for CD-ROM...  
CD-ROM found.  
Reading file "SK8N.rom". Completed.  
Start flashing...
```



DO NOT shutdown or reset the system while updating the BIOS! Doing so may cause system boot failure!

4. When the BIOS update process is complete, reboot the system.

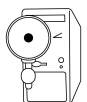

The recovered BIOS may not be the latest BIOS version for this motherboard. Visit ASUS website (www.asus.com) to download the latest BIOS file.

4.2 BIOS Setup program

This motherboard supports a programmable firmware that you can update using the provided utility described in section “4.1 Managing and updating your BIOS.”

Use the BIOS Setup program when you are installing a motherboard, reconfiguring your system, or prompted to “Run Setup”. This section explains how to configure your system using this utility.

Even if you are not prompted to use the Setup program, you may want to change the configuration of your computer in the future. For example, you may want to enable the security password feature or change the power management settings. This requires you to reconfigure your system using the BIOS Setup program so that the computer can recognize these changes and record them in the CMOS RAM of the firmware hub.

The firmware hub on the motherboard stores the Setup utility. When you start up the computer, the system provides you with the opportunity to run this program. Press <Delete> during the Power-On Self Test (POST) to enter the Setup utility. Otherwise, POST continues with its test routines.

If you wish to enter Setup after POST, restart the system by pressing <Ctrl> + <Alt> + <Delete>, or by pressing the reset button on the system chassis. You can also restart by turning the system off and then back on. Do this last option only if the first two failed.

The Setup program is designed to make it as easy to use as possible. It is a menu-driven program, which means you can scroll through the various sub-menus and make your selections from the available options using the navigation keys.

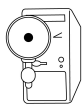

The default BIOS settings for this motherboard apply for most conditions to ensure optimum performance. If the system becomes unstable after changing any BIOS settings, load the default settings to ensure system compatibility and stability. Select the **Load Default Settings** item under the Exit Menu. See section “4.7 Exit Menu.”



The BIOS setup screens shown in this chapter are for reference purposes only, and may not exactly match what you see on your screen.

Visit the ASUS website (www.asus.com) to download the latest product and BIOS information.

4.2.1 BIOS menu screen

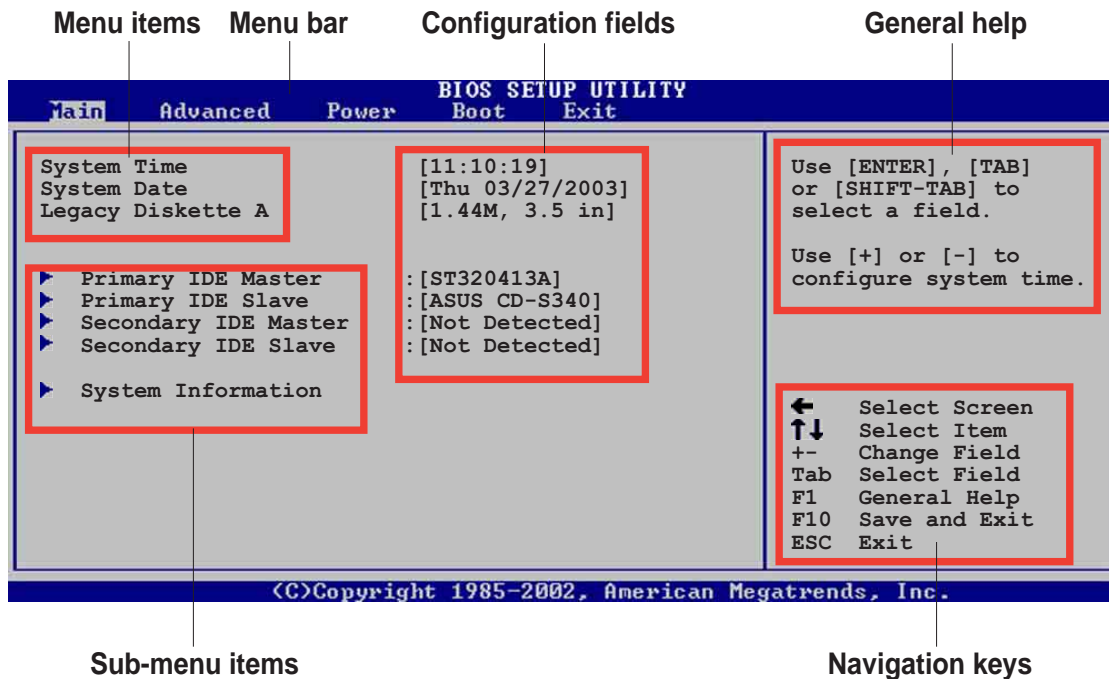

4.2.2 Menu bar

The menu bar on top of the screen has the following main items:

- Main** For changing the basic system configuration
- Advanced** For changing the advanced system settings
- Power** For changing the advanced power management (APM) configuration
- Boot** For changing the system boot configuration
- Exit** For selecting the exit options and loading default settings

To select an item on the menu bar, press the right or left arrow key on the keyboard until the desired item is highlighted.

4.2.3 Navigation keys

At the **bottom right corner** of a menu screen are the navigation keys for that particular menu. Use the navigation keys to select items in the menu and change the settings.



Some of the navigation keys differ from one screen to another.

4.2.4 Menu items

The highlighted item on the menu bar displays the specific items for that menu. For example, selecting **Main** shows the Main menu items.

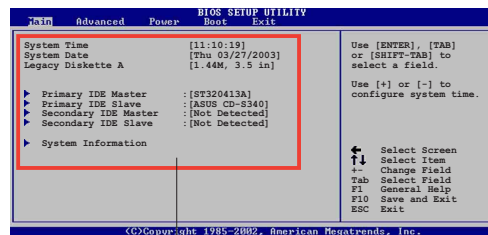

Main menu items

The other items (Advanced, Power, Boot, and Exit) on the menu bar have their respective menu items.

4.2.5 Sub-menu items

An item with a sub-menu on any menu screen is distinguished by a solid triangle before the item. To display the sub-menu, select the item and press Enter.

4.2.6 Configuration fields

These fields show the values for the menu items. If an item is user-configurable, you may change the value of the field opposite the item. You can not select an item that is not user-configurable.

A configurable field is enclosed in brackets, and is highlighted when selected. To change the value of a field, select it then press Enter to display a list of options. Refer to “4.2.7 Pop-up window.”

4.2.7 Pop-up window

Select a menu item then press Enter to display a pop-up window with the configuration options for that item.

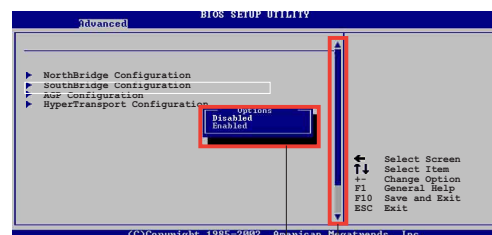

Pop-up window

Scroll bar

4.2.8 Scroll bar

A scroll bar appears on the right side of a menu screen when there are items that do not fit on the screen. Press **Up/Down arrow keys** or **PageUp/PageDown keys** to display the other items on the screen.

4.2.9 General help

At the top right corner of the menu screen is a brief description of the selected item.

4.3 Main menu

When you enter the BIOS Setup program, the Main menu screen appears giving you an overview of the basic system information.

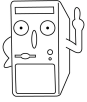

Refer to section “4.2.1 BIOS menu screen” for information on the menu screen items and how to navigate through them.

```
BIOS SETUP UTILITY
Main  Advanced  Power  Boot  Exit

System Time           [11:10:19]
System Date           [Thu 03/27/2003]
Legacy Diskette A     [1.44M, 3.5 in]

▶ Primary IDE Master   : [ST320413A]
▶ Primary IDE Slave    : [ASUS CD-S340]
▶ Secondary IDE Master : [Not Detected]
▶ Secondary IDE Slave  : [Not Detected]
▶ System Information

Use [ENTER], [TAB]
or [SHIFT-TAB] to
select a field.

Use [+] or [-] to
configure system time.

← Select Screen
↑↓ Select Item
+- Change Field
Tab Select Field
F1 General Help
F10 Save and Exit
ESC Exit

(C)Copyright 1985-2002, American Megatrends, Inc.
```

4.3.1 System Time [xx:xx:xxxx]

This item allows you to set the system time.

4.3.2 System Date [Day xx/xx/xxxx]

This item allows you to set the system date.

4.3.3 Legacy Diskette A [1.44M, 3.5 in.]

Sets the type of floppy drive installed. Configuration options: [Disabled] [360K, 5.25 in.] [1.2M , 5.25 in.] [720K , 3.5 in.] [1.44M, 3.5 in.] [2.88M, 3.5in.]

4.3.4 Primary and Secondary IDE Master/Slave

While entering Setup, BIOS auto-detects the presence of IDE devices. There is a separate sub-menu for each IDE device. Select a device item then press Enter to display the IDE device information.

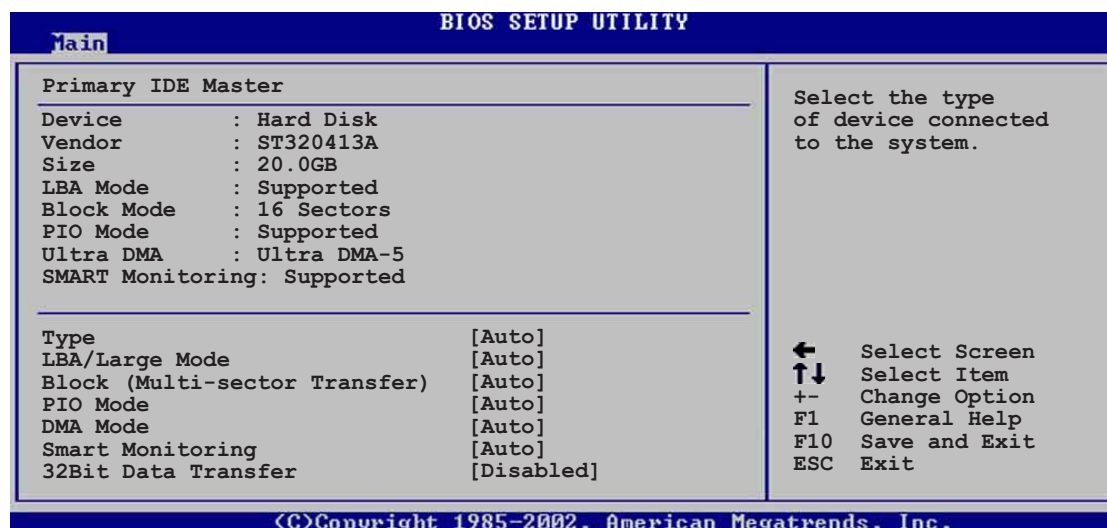

The values opposite the dimmed items (Device, Vendor, Size, LBA Mode, Block Mode, PIO Mode, Async DMA, Ultra DMA, and SMART monitoring) are auto-detected by BIOS and are not user-configurable. These items show N/A if no IDE device is installed in the system.

Type [Auto]

Selects the type of IDE drive. Setting to Auto allows automatic selection of the appropriate IDE device type. Select CDROM if you are specifically configuring a CD-ROM drive. Select ARMD (ATAPI Removable Media Device) if your device is either a ZIP, LS-120, or MO drive. Configuration options: [Not Installed] [Auto] [CDROM] [ARMD]

LBA/Large Mode [Auto]

Enables or disables the LBA mode. Setting to Auto enables the LBA mode if the device supports this mode, and if the device was not previously formatted with LBA mode disabled. Configuration options: [Disabled] [Auto]

Block (Multi-sector Transfer) [Auto]

Enables or disables data multi-sectors transfers. When set to Auto, the data transfer from and to the device occurs multiple sectors at a time if the device supports multi-sector transfer feature. When set to Disabled, the data transfer from and to the device occurs one sector at a time. Configuration options: [Disabled] [Auto]

PIO Mode [Auto]

Selects the PIO mode. Configuration options: [Auto] [0] [1] [2] [3] [4]

DMA Mode [Auto]

Selects the DMA mode. Configuration options: [Auto] [SWDMA0] [SWDMA1] [SWDMA2] [MWDMA0] [MWDMA1] [MWDMA2] [UDMA0] [UDMA1] [UDMA2] [UDMA3] [UDMA4] [UDMA5]

SMART Monitoring [Auto]

Sets the Smart Monitoring, Analysis, and Reporting Technology. Configuration options: [Auto] [Disabled] [Enabled]

32Bit Data Transfer [Disabled]

Enables or disables 32-bit data transfer. Configuration options: [Disabled] [Enabled]

4.3.5 System Information

This menu gives you an overview of the general system specifications. The items in this menu are auto-detected by BIOS.

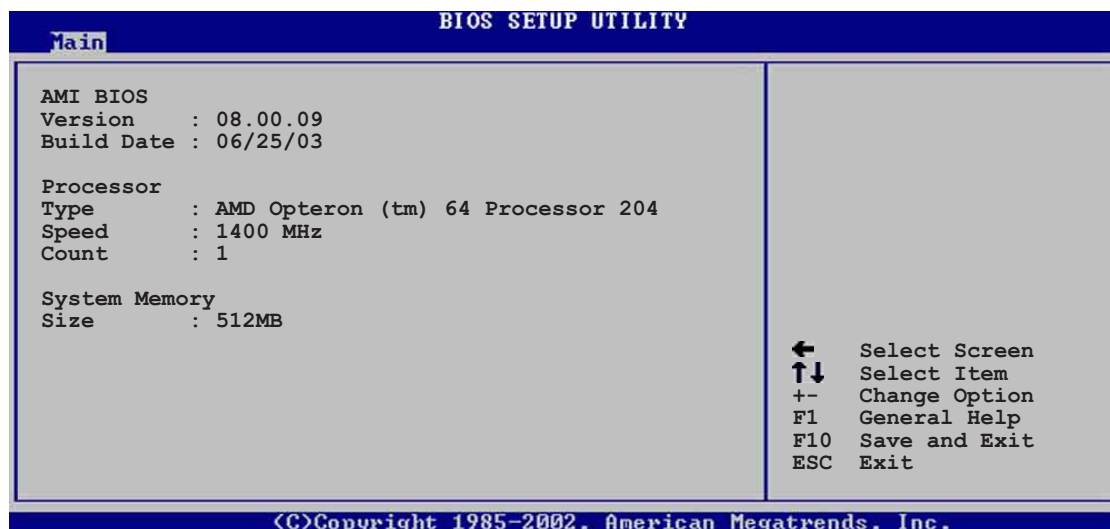

AMI BIOS

This item displays the auto-detected BIOS information.

Processor

This item displays the auto-detected CPU specification.

System Memory

This item displays the auto-detected system memory.

4.4 Advanced menu

The Advanced menu items allow you to change the settings for the CPU and other system devices.



Take caution when changing the settings of the Advanced menu items. Incorrect field values may cause the system to malfunction.

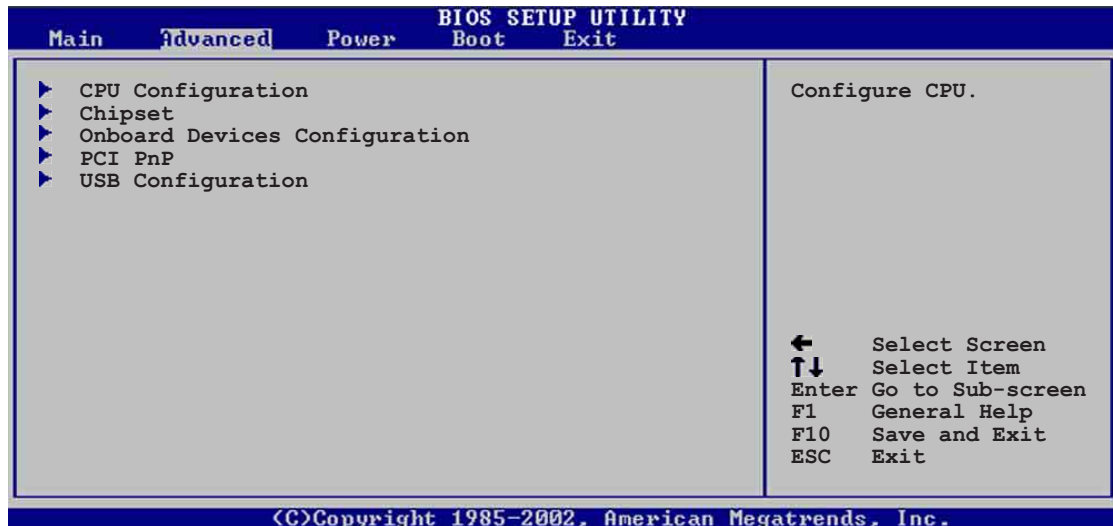

4.4.1 CPU Configuration

The items in this menu show the CPU-related information auto-detected by BIOS.

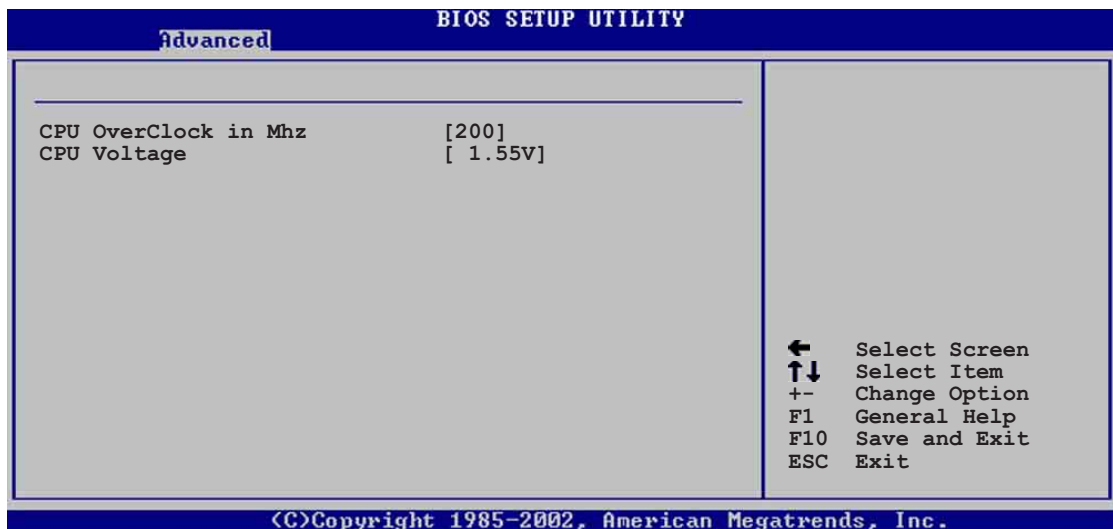

CPU Overclock in MHz [200]

This item allows user input of the FSB Frequency ranged from 200 MHz to 300 MHz. Any value entered that is not in this range will have no effect or the system will be unstable if the selected FSB Speed is not supported.



If the system fails due to overclocking, unplug the power cable; wait for 10 seconds then plug again to power source and restart system.

CPU Voltage [1.55V]

This item allows you to select a specific CPU Voltage. Take caution in setting CPU Voltage, a very high voltage may severely damage the CPU! Configuration options: [1.55V] [1.65V] [1.75V]

4.4.2 Chipset

The Chipset menu items allow you to change the advanced chipset settings. Select an item then press Enter to display the sub-menu.

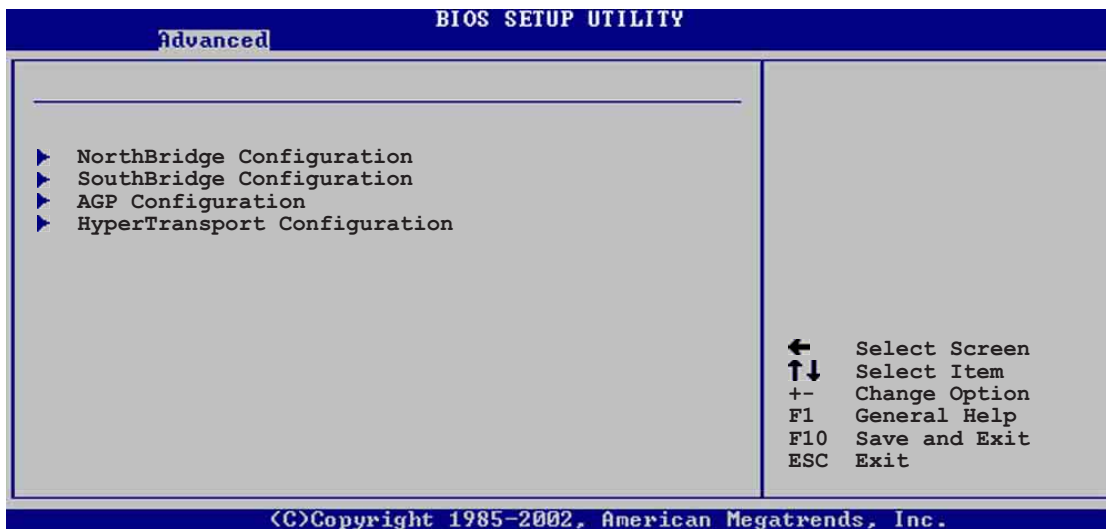

4.4.2.1 NorthBridge Configuration

The Chipset menu item allow you to change the NorthBridge settings. Select an item then press Enter to display the sub-menu.

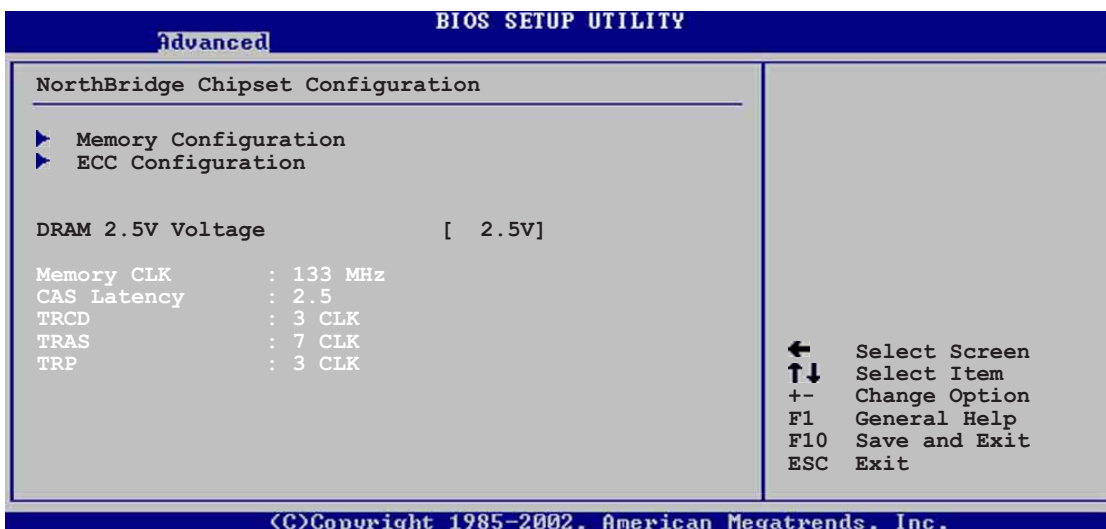

Memory CLK [133MHz]

This item displays the memory clock speed setting.

CAS Latency [2.5]

This item displays the CAS Latency setting.

TRCD [3 CLK]

This item displays the TRCD clock setting.

TRAS [7 CLK]

This item displays the TRAS clock setting.

TRP [3 CLK]

This item displays the TRP clock setting.

4.4.2.1.1 Memory Configuration

The Northbridge configuration menu item allow you to change the memory settings. Select an item then press Enter to display the sub-menu.

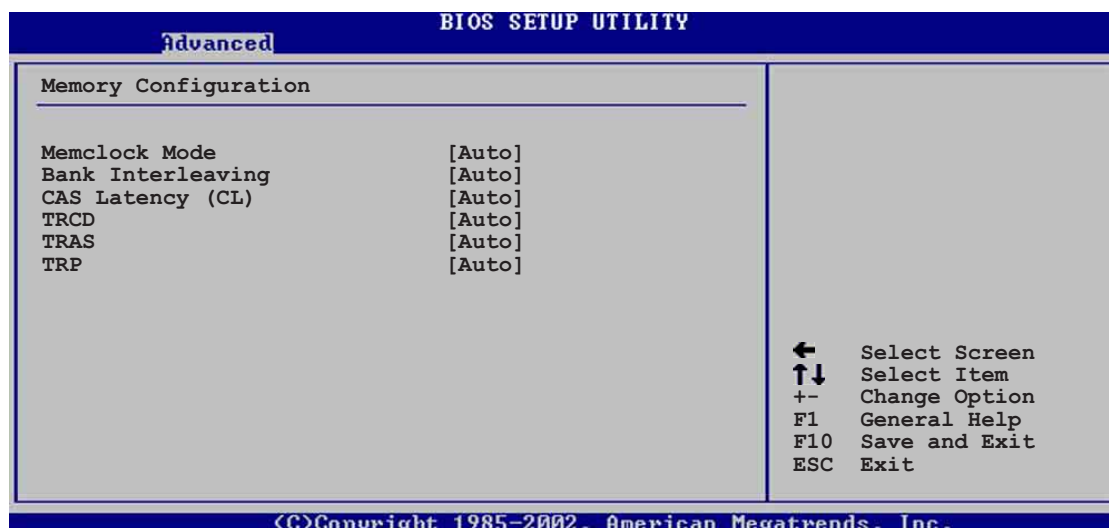

Memclock Mode [Auto]

This item allows you to set the memory clock mode. Set by the code using [Auto] or select [Manual] to set using one of the standard values.

Configuration options: [Auto] [Manual]

Memclock Value [100 MHz]

This item appears when Memclock Mode is set to [Limit]. Configuration options: [100 Mhz] [133 Mhz] [150 Mhz] [166 MHz] [200 Mhz]

Bank Interleaving [Auto]

This item sets whether to allow memory accesses to be spread out over BANKS on the same node or across nodes, decreasing access contention.

Configuration options: [Auto] [Disabled]

CAS Latency (CL) [Auto]

This item sets the CAS Latency.

Configuration options: [Auto] [2.0] [3.0] [2.5]

TRCD [Auto]

This item sets the TRCD.

Configuration options: [Auto] [2 CLK] [3 CLK] [4 CLK] [5 CLK] [6 CLK]

TRAS [Auto]

This item sets the TRAS.

Configuration options: [Auto] [5 CLK] [6 CLK] [7 CLK] [8 CLK] [9 CLK] [10 CLK] [11 CLK] [12 CLK] [13 CLK] [14 CLK] [15 CLK]

TRP [Auto]

This item sets the TRP.

Configuration options: [Auto] [2 CLK] [3 CLK] [4 CLK] [5 CLK] [6 CLK]

4.4.2.1.2 ECC Configuration

The Northbridge configuration menu item allow you to change the ECC settings. Select an item then press Enter to display the sub-menu.

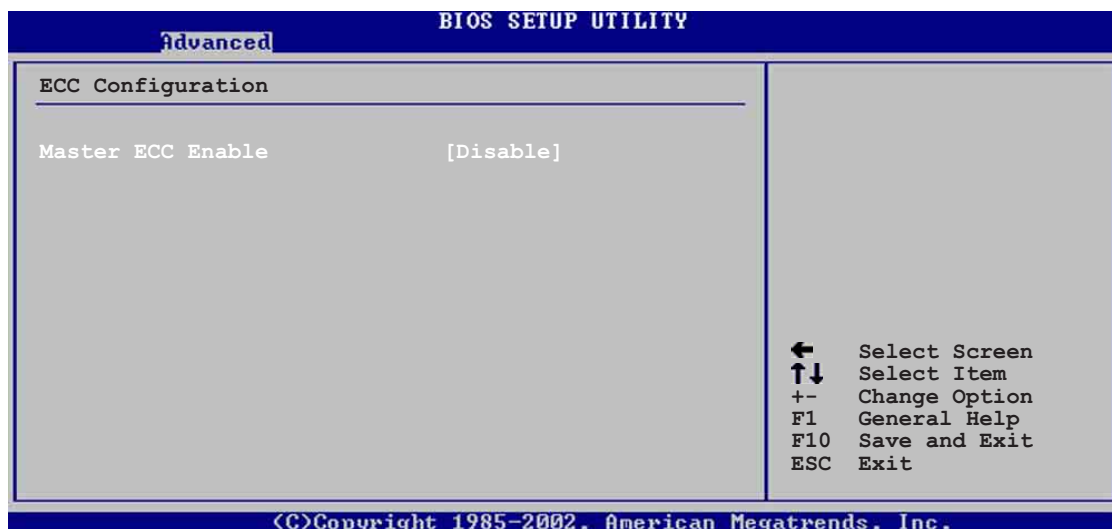

Master ECC Enable [Disabled]

This item enables or disables support on all nodes for ECC error detect and correction. Configuration options: [Disabled] [Enabled]

DRAM 2.5V Voltage [2.5V]

This item enables you to set the DRAM Voltage. Configuration options: [2.5V] [2.6V] [2.7V]

4.4.2.2 South Bridge Configuration

The Chipset menu item allow you to change the South Bridge settings. Select an item then press Enter to display the sub-menu.

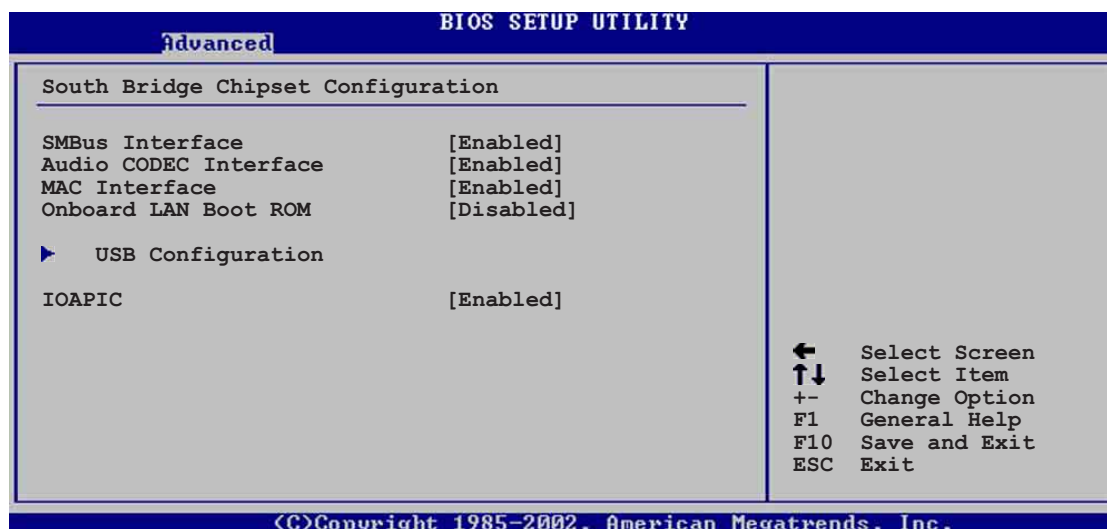

SMBus Interface [Enabled]

This item enables or disables the SMBus controller. Configuration options: [Enabled] [Disabled]

Audio CODEC Interface [Enabled]

This item enables or disables the internal Audio CODEC interface. Configuration options: [Enabled] [Disabled] [Auto]

MAC Interface [Enabled]

This item enables or disables the internal 802.3 MAC interface. Configuration options: [Enabled] [Disabled]

Onboard LAN Boot ROM [Disabled]

This item enables or disables the onboard LAN Boot ROM. Configuration options: [Disabled] [Enabled]

4.4.2.2.1 *USB Configuration*

The items in this menu allows you to change the USB-related features. Select an item then press Enter to display the configuration options.

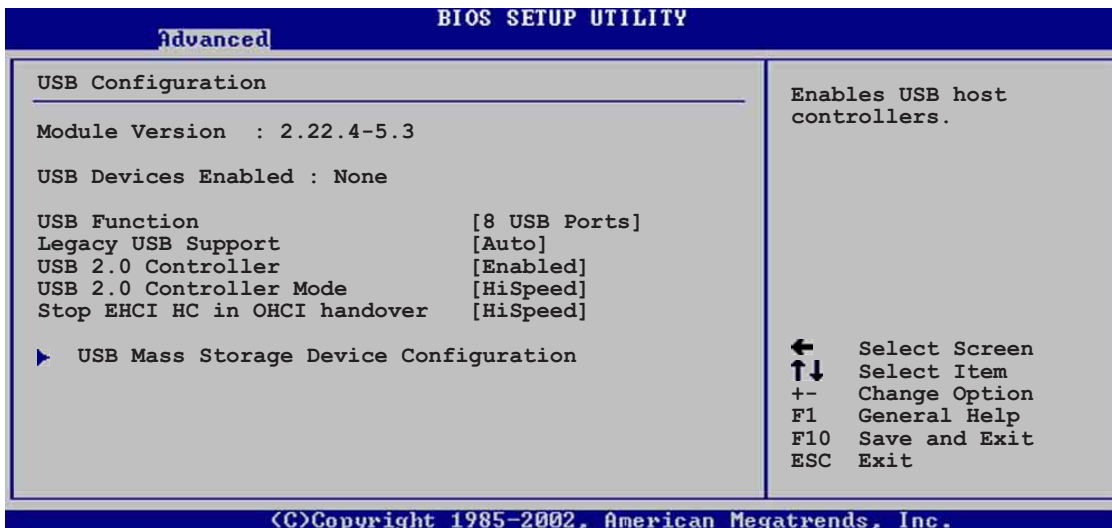

The Module Version and USB Devices Enabled items show the auto-detected values. If no USB device is detected, the item shows None.

USB Function [Both Controllers]

Allows you to set the number of USB ports to activate.
Configuration options: [Disabled] [Both Controllers]

Legacy USB Support [Enabled]

Allows you to enable or disable support for legacy USB devices. Setting to Auto allows the system to detect the presence of USB devices at startup. If detected, the USB controller legacy mode is enabled. If no USB device is detected, the legacy USB support is disabled.
Configuration options: [Disabled] [Enabled] [Auto]

USB 2.0 Controller [Enabled]

Allows you to enable or disable the USB 2.0 controller.
Configuration options: [Disabled] [Enabled]

USB 2.0 Controller Mode [HiSpeed]

Allows you to configure the USB 2.0 controller in HiSpeed (480 Mbps) or Full Speed (12 Mbps). Configuration options: [Full Speed] [HiSpeed]

Stop EHCI HC in OHCI handover [HiSpeed]

Allows you to configure the Stop EHCI HC in OHCI handover speed.
Configuration options: [Full Speed] [HiSpeed]

USB Mass Storage Device Configuration

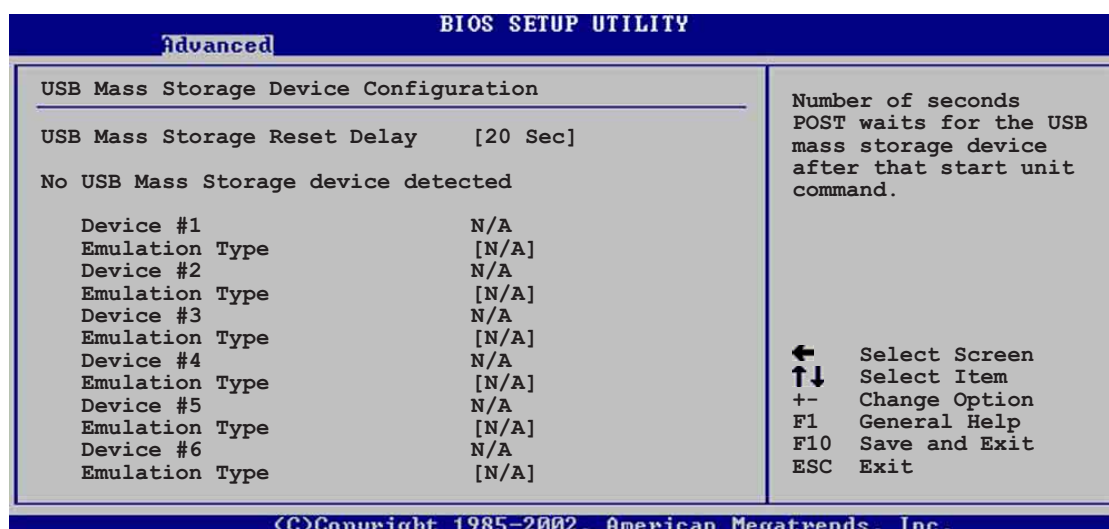

USB Mass Storage Reset Delay [20 Sec]

Allows you to select the number of seconds POST waits for the USB mass storage device after the start unit command. The message “No USB mass storage device detected” appears if none is installed in the system. Configuration options: [10 Sec] [20 Sec] [30 Sec] [40 Sec]

Emulation Type [N/A]

When set to Auto, USB devices less than 530MB will be emulated as floppy drive, and the remaining drives as hard drives. Forced FDD option can be used to force an HDD formatted drive to boot as FDD (for example, ZIP drive).



The Device and Emulation Type items appear only when there are installed USB devices.

IOAPIC [Enabled]

This item enables or disables the IO APIC.

Configuration options: [Disabled] [Enabled]

4.4.2.3 AGP Configuration

The Chipset menu item allow you to change the AGP settings. Select an item then press Enter to display the sub-menu.

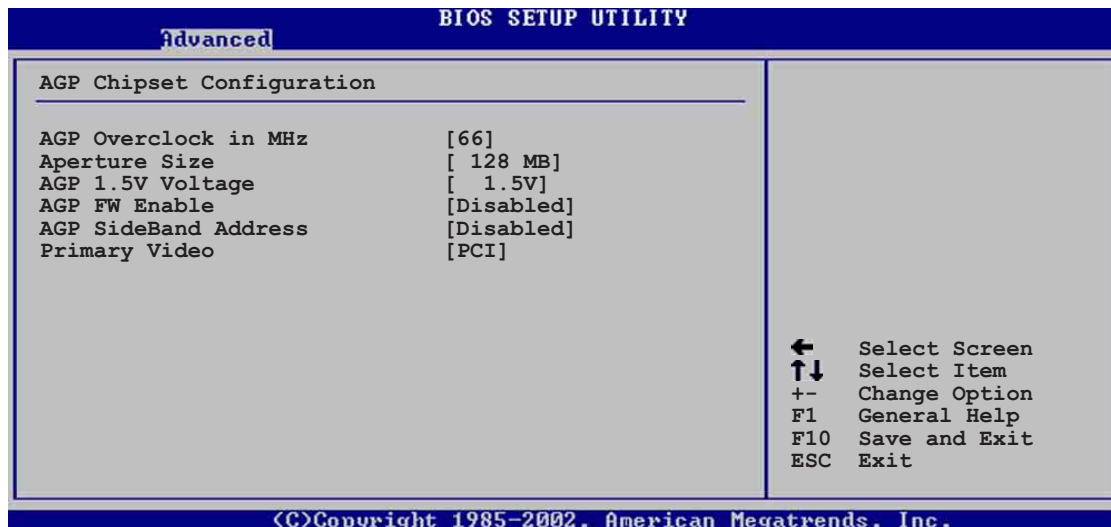

AGP Overclock in MHz [66]

This item sets the AGP Frequency ranged from 66 to 75 (MHz). Any value that is not within this range will have no effect. Unsupported values may cause the system to become unstable.

Aperture Size [128 MB]

This item sets the Aperture size for the AGP Video controller, it does not consume real system memory.

Configuration options: [32 MB] [64 MB] [128 MB] [256 MB] [512 MB]

AGP 1.5V Voltage

This item sets the AGP voltage setting.

Configuration options: [1.5V] [1.6V] [1.7V]

AGP FW Enable [Disabled]

This item enables or disables the AGP FW Enable.

Configuration options: [Disabled] [Enabled]

AGP SideBand Address [Disabled]

This item enables or disables the AGP SideBand address.

Configuration options: [Disabled] Enabled]

Primary Video [PCI]

This item will switch the PCI Bus scanning order while searching for a video card. This allows to select the type of Primary VGA in case of multiple video controllers. Configuration options: [PCI] [AGP]

4.4.2.3 HyperTransport Configuration

The Chipset menu item allow you to change the HyperTransport settings. Select an item then press Enter to display the sub-menu.

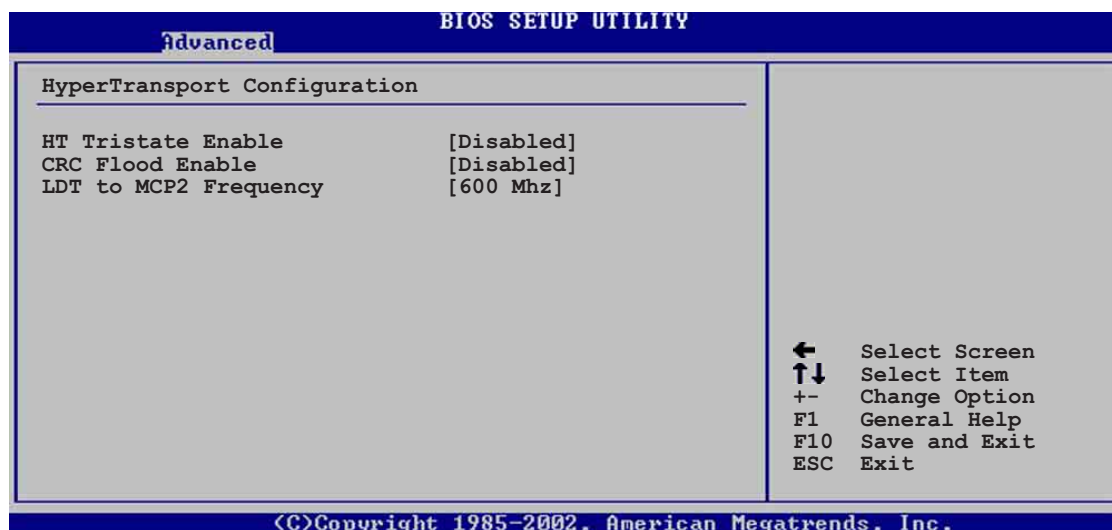

HT Tristate Enable [Disabled]

This item enables or disables the HyperTransport Tristate that enables the link tristate during the disconnected state of an LDTSTOP. Configuration options: [Disabled] [Enabled]

CRC Flood Enable [Disabled]

This item enables or disables the CRC Flood that enable the generation of synchronized packets on CRC Error. Configuration options: [Disabled] [Enabled]

LDT to MCP2 Frequency [600 MHz]

This item enables or disables the LCT to MCP2 frequency. Configuration options: [200 MHz] [400 Mhz] [600 Mhz]

4.4.3 Onboard Devices Configuration

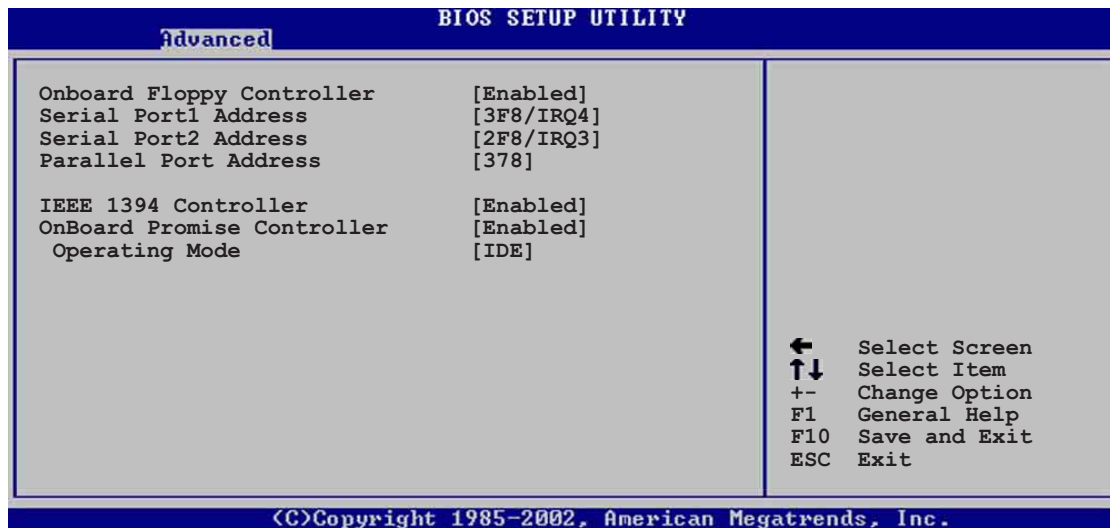

OnBoard Floppy Controller [Enabled]

Allows you to enable or disable the floppy disk controller. Configuration options: [Disabled] [Enabled]

Serial Port1 Address [3F8/IRQ4]

Allows you to select the Serial Port1 base address. Configuration options: [Disabled] [3F8/IRQ4] [3E8/IRQ4] [2E8/IRQ3]

Serial Port2 Address [2F8/IRQ3]

Allows you to select the Serial Port2 base address. Configuration options: [Disabled] [2F8/IRQ3] [3E8/IRQ4] [2E8/IRQ3]

Parallel Port Address [378]

Allows you to select the Parallel Port base addresses. Configuration options: [Disabled] [378] [278] [3BC]



The following items appear only when the Parallel Port Address item is not set to [Disabled].

Parallel Port Mode [Normal]

Allows you to select the Parallel Port mode. Configuration options: [Normal] [EPP] [ECP]

Parallel Port IRQ [IRQ7]

Allows you to select the Parallel Port IRQ. Configuration options: [IRQ5] [IRQ7]

IEEE 1394 Controller [Enabled]

This item enables or disables the IEEE 1394 controller.

Configuration options: [Enabled] [Disabled]

OnBoard Promise Controller [Enabled]

This item enables or disables the onboard Promise controller.

Configuration options: [Enabled] [Disabled]

Operating Mode [IDE]

This item sets the system operating mode.

Configuration options: [RAID] [IDE]

4.4.4 PCI PnP

The PCI PnP menu items allow you to change the advanced settings for PCI/PnP devices. The menu includes setting IRQ and DMA channel resources for either PCI/PnP or legacy ISA devices, and setting the memory size block for legacy ISA devices.



Take caution when changing the settings of the PCI PnP menu items. Incorrect field values may cause the system to malfunction.

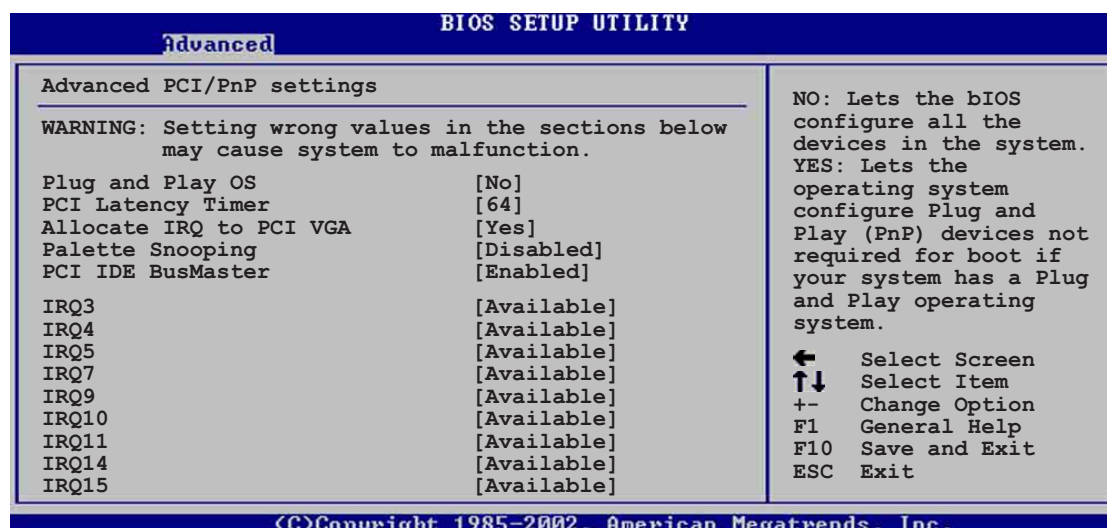

Plug and Play O/S [No]

When set to [No], BIOS configures all the devices in the system. When set to [Yes] and if you installed a Plug & Play operating system, the operating system configures the Plug & Play devices not required for boot.

Configuration options: [No] [Yes]

PCI Latency Timer [64]

Allows you to select the value in units of PCI clocks for the PCI device latency timer register. Configuration options: [32] [64] [96] [128] [160] [192] [224] [248]

Allocate IRQ to PCI VGA [Yes]

When set to [Yes], BIOS assigns an IRQ to PCI VGA card if the card requests for an IRQ. When set to [No], BIOS does not assign an IRQ to the PCI VGA card even if requested. Configuration options: [Yes] [No]

Pallete Snooping [Disabled]

When set to [Enabled], the pallete snooping feature informs the PCI devices that an ISA graphics device is installed in the system so that the latter can function correctly. Setting to [Disabled] deactivates this feature. Configuration options: [Disabled] [Enabled]

PCI IDE BusMaster [Enabled]

Allows BIOS to use PCI bus mastering when reading/writing to IDE devices. Configuration options: [Disabled] [Enabled]

IRQ xx [Available]

When set to [Available], the specific IRQ is free for use of PCI/PnP devices. When set to [Reserved], the IRQ is reserved for legacy ISA devices. Configuration options: [Available] [Reserved]

4.5 Power menu

The Power menu items allow you to change the settings for the Advanced Power Management (APM). Select an item then press Enter to display the configuration options.

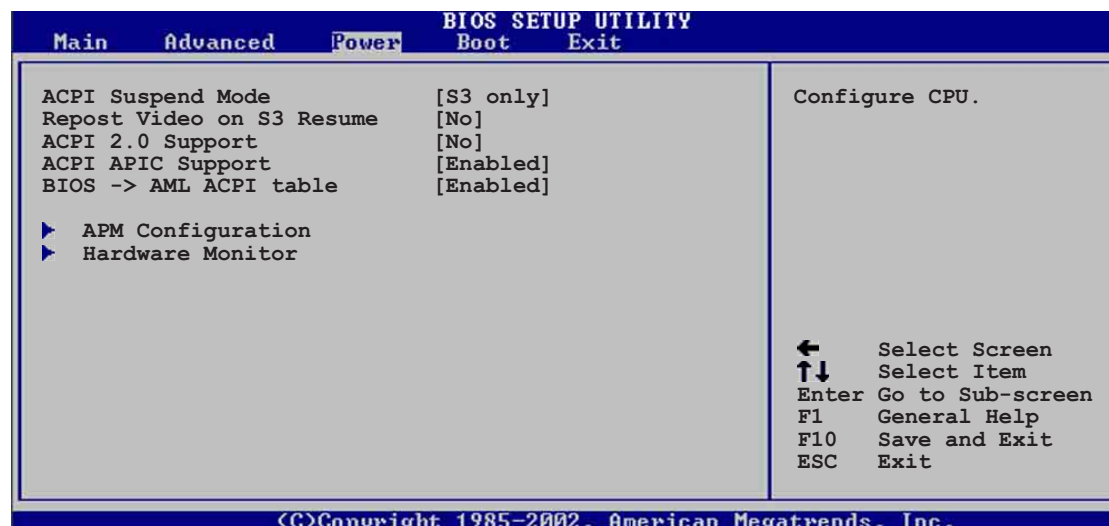

4.5.1 ACPI Suspend Mode [S3 only]

Allows you to select the ACPI state to be used for system suspend.
Configuration options: [S1 (POS) Only] [S3 Only]

4.5.2 Repost Video on S3 Resume [No]

Determines whether to invoke VGA BIOS POST on S3/STR resume.
Configuration options: [No] [Yes]

4.5.3 ACPI 2.0 Support [No]

Allows you to add more tables for ACPI 2.0 specifications. Configuration options: [No] [Yes]

4.5.4 ACPI APIC Support [Enabled]

Allows you to enable or disable the ACPI support in the ASIC. When set to Enabled, the ACPI APIC table pointer is included in the RSDT pointer list.
Configuration options: [Disabled] [Enabled]

4.5.5 BIOS -> AML ACPI Table [Enabled]

Allows you to enable or disable the inclusion of the BIOS ->AML exchange pointer to (X)RSDT pointer list. Configuration options: [Disabled] [Enabled]

4.5.6 APM Configuration

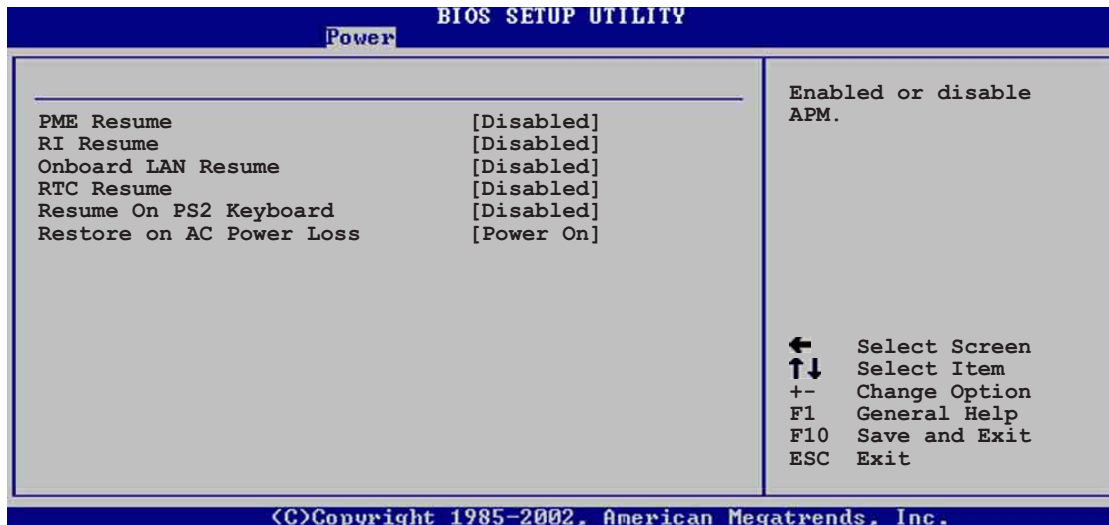

PME Resume [Disabled]

Allows you to enable or disable the PME to generate a wake event.
Configuration options: [Disabled] [Enabled]

RI Resume [Disabled]

Allows you to enable or disable the RI to generate a wake event.
Configuration options: [Disabled] [Enabled]

Onboard LAN Resume [Disabled]

Allows you to enable or disable the internal 802.3 MAC onboard LAN to generate PME in SoftOFF mode.
Configuration options: [Disabled] [Enabled]

RTC Resume [Disabled]

Allows you to enable or disable the RTC event to wake after a power failure. Configuration options: [Disabled] [Enabled]

Resume On PS2 Keyboard [Disabled]

Allows you to enable or disable the PS2 keyboard to generate a wake event. Configuration options: [Disabled] [Enabled]

Restore on AC Power Loss [Power On]

Allows you to set the restore power setting on the event of an AC power loss. Configuration options: [Power Off] [Power On] [Last State]

4.5.7 Hardware Monitor

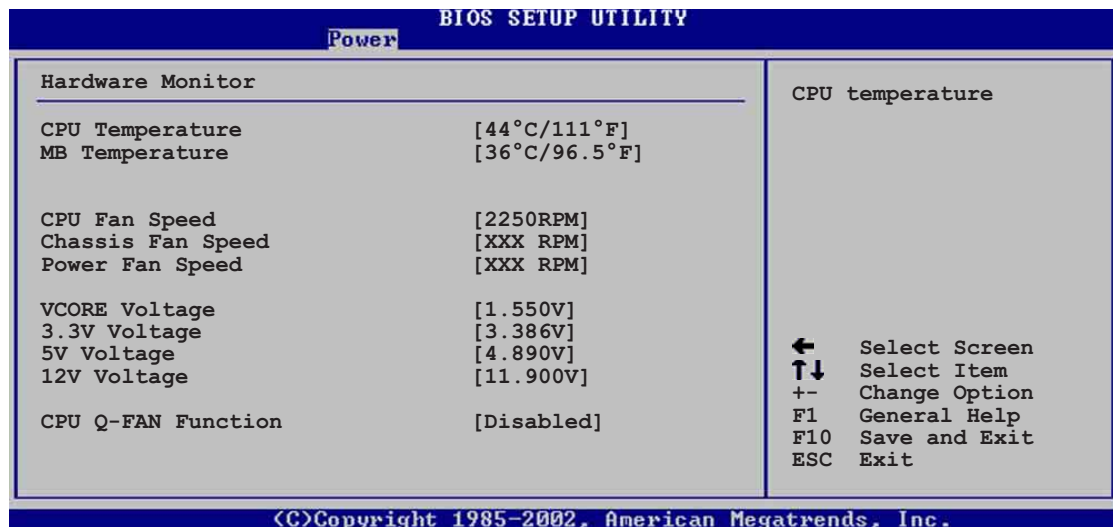

MB Temperature [xxxC/xxxF]

CPU Temperature [xxxC/xxxF]

The onboard hardware monitor automatically detects and displays the motherboard and CPU temperatures. Select Disabled if you do not wish to display the detected temperatures.

CPU Fan Speed [xxxxRPM] or [N/A]

Chassis Fan Speed [xxxxRPM] or [N/A]

Power Fan Speed [xxxxRPM] or [N/A]

The onboard hardware monitor automatically detects and displays the CPU, chassis, and power fan speeds in rotations per minute (RPM). If any of the fans is not connected to the motherboard, the specific field shows N/A.

VCORE Voltage, +3.3V Voltage, +5V Voltage, +12V Voltage

The onboard hardware monitor automatically detects the voltage output through the onboard voltage regulators.



If any of the monitored items is out of range, the following error message appears: "Hardware Monitor found an error. Enter Power setup menu for details". You will then be prompted to "Press F1 to continue or DEL to enter SETUP".

CPU Q-FAN Function [Disabled]

This item allows you to enable or disable the ASUS Q-Fan feature that smartly adjusts the fan speeds for more efficient system operation.

Configuration options: [Disabled] [Enabled]



The above item appears only when the **CPU Q-FAN Function** item is set to Enabled.

CPU Fan High Temp [55°C]

This item sets the CPU fan high temperature mark.

Configuration options: [35°C] ~ [75°C]

CPU Fan Medium Temp [45°C]

This item sets the CPU fan medium temperature mark.

Configuration options: [35°C] ~ [75°C]

CPU Fan Low Temp [40°C]

This item sets the CPU fan low temperature mark.

Configuration options: [35°C] ~ [75°C]

CPU Fan High Voltage [12.0V]

This item sets the CPU fan high voltage mark.

Configuration options: [5.5V] [6.0V] [6.5V] [7.0V] [7.5V] [8.0V] [8.5V] [9.0V] [9.5V] [10.0V] [10.5V] [11.0V] [11.5V] [12.0V]

CPU Fan Medium Voltage [9.0V]

This item sets the CPU fan medium voltage mark.

Configuration options: [5.5V] [6.0V] [6.5V] [7.0V] [7.5V] [8.0V] [8.5V] [9.0V] [9.5V] [10.0V] [10.5V] [11.0V] [11.5V] [12.0V]

CPU Fan Low Voltage [7.5V]

This item sets the CPU fan low voltage mark.

Configuration options: [5.5V] [6.0V] [6.5V] [7.0V] [7.5V] [8.0V] [8.5V] [9.0V] [9.5V] [10.0V] [10.5V] [11.0V] [11.5V] [12.0V]

4.6 Boot menu

The Boot menu items allow you to change the system boot options. Select an item then press Enter to display the sub-menu.

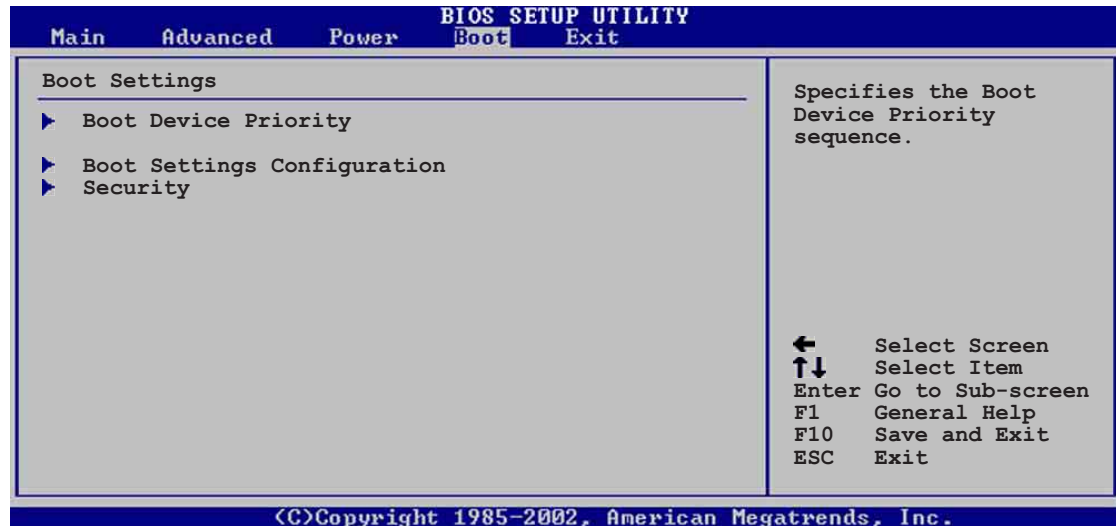

4.6.1 Boot Device Priority

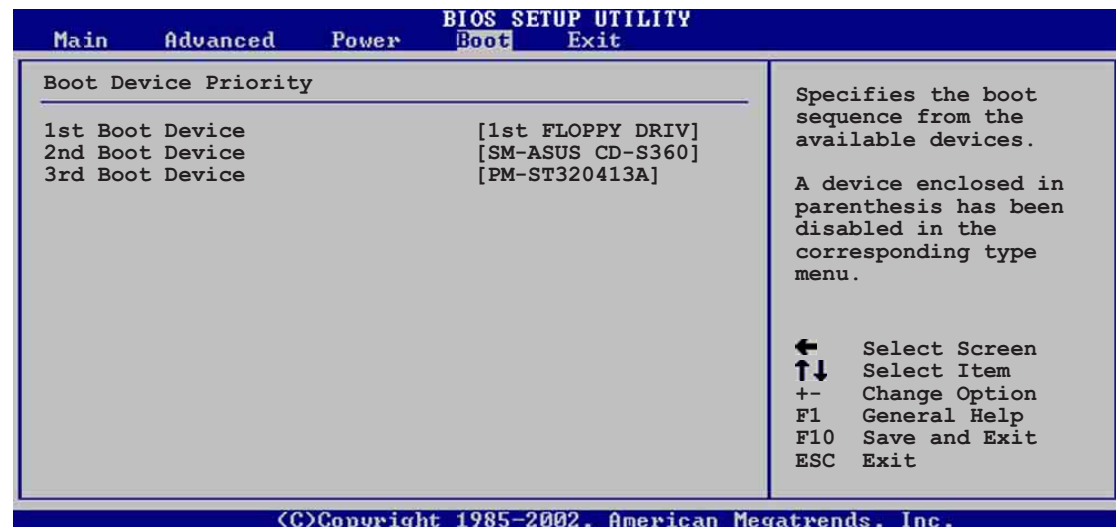

1st ~ xxth Boot Device [1st Floppy Drive]

These items specify the boot device priority sequence from the available devices. The number of device items that appear on the screen depends on the the number of devices installed in the system. Configuration options: [xxxxx Drive] [Disabled]

4.6.2 Boot Settings Configuration

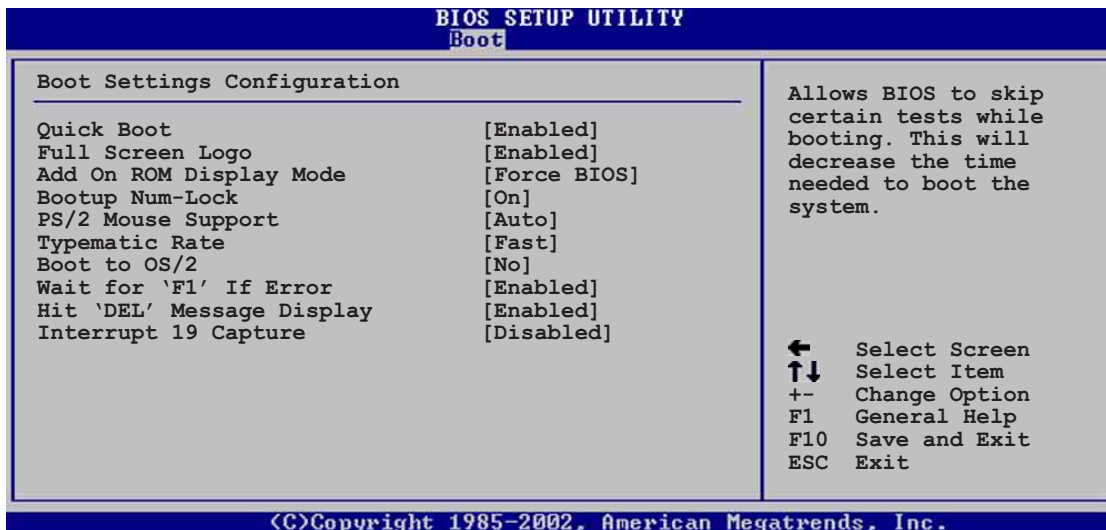

Quick Boot [Enabled]

Enabling this item allows the BIOS to skip some power on self tests (POST) while booting to decrease the time needed to boot the system. When set to [Disabled], BIOS performs all the POST items. Configuration options: [Disabled] [Enabled]

Full Screen Logo [Enabled]

This allows you to enable or disable the full screen logo display feature. Configuration options: [Disabled] [Enabled]



Make sure that the above item is set to [Enabled] if you wish to use the ASUS MyLogo2™ feature.

Add On ROM Display Mode [Force BIOS]

Sets the display mode for option ROM. Configuration options: [Force BIOS] [Keep Current]

Bootup Num-Lock [On]

Allows you to select the power-on state for the NumLock. Configuration options: [Off] [On]

PS/2 Mouse Support [Enabled]

Allows you to enable or disable support for PS/2 mouse. Configuration options: [Disabled] [Enabled]

Typematic Rate [Fast]

Allows you to select the keyboard typematic rate. Configuration options:
[Slow] [Fast]

Boot to OS/2 [No]

Allows you to specify the OS/2 compatibility mode. Configuration options:
[No] [Yes]

Wait for 'F1' If Error [Enabled]

When set to Enabled, the system waits for F1 key to be pressed when error occurs. Configuration options: [Disabled] [Enabled]

Hit 'DEL' Message Display [Enabled]

When set to Enabled, the system displays the message "Press DEL to run Setup" during POST. Configuration options: [Disabled] [Enabled]

Interrupt 19 Capture [Disabled]

When set to [Enabled], this function allows the option ROMs to trap Interrupt 19. Configuration options: [Disabled] [Enabled]

4.6.3 Security

The Security menu items allow you to change the system security settings. Select an item then press Enter to display the configuration options.

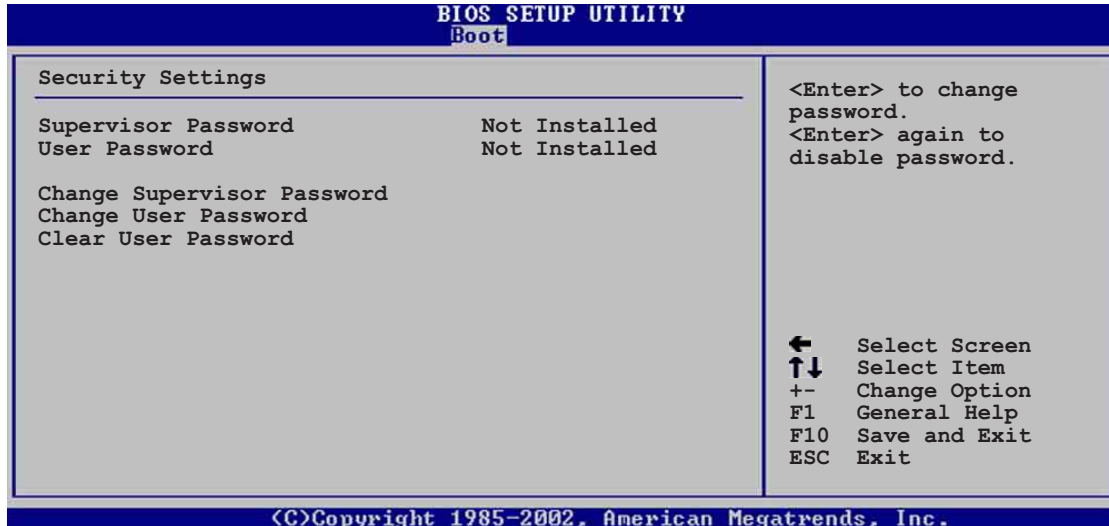

Change Supervisor Password

Select this item to set or change the supervisor password. The Supervisor Password item on top of the screen shows the default **Not Installed**. After you have set a password, this item shows **Installed**.

To set a Supervisor Password:

1. Select the Change Supervisor Password item and press Enter.
2. On the password box that appears, type a password composed of letters and/or numbers, then press Enter. Your password should have at least six characters.
3. Confirm the password when prompted.
The message "Password Installed" appears after you have successfully set your password.

The Supervisor Password item now shows **Installed**.

To change the supervisor password, follow the same steps as in setting a user password.

To clear the supervisor password, select the Change Supervisor Password then press Enter. The message "Password Uninstalled" appears.

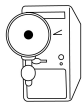

If you forget your BIOS password, you can clear it by erasing the CMOS Real Time Clock (RTC) RAM. See section "2.7 Jumpers" for information on how to erase the RTC RAM.

After you have set a supervisor password, the other items appear to allow you to change other security settings.



User Access Level (Full Access]

This item allows you to select the access restriction to the Setup items. Configuration options: [No Access] [View Only] [Limited] [Full Access]

No Access prevents user access to the Setup utility.

View Only allows access but does not allow change to any field.

Limited allows change to only selected fields, such as Date and Time.

Full Access allows viewing and changing all the fields in the Setup utility.

Change User Password

Select this item to set or change the user password. The User Password item on top of the screen shows the default **Not Installed**. After you have set a password, this item shows **Installed**.

To set a User Password:

1. Select the Change User Password item and press Enter.
2. On the password box that appears, type a password composed of letters and/or numbers, then press Enter. Your password should have at least six characters.
3. Confirm the password when prompted.
The message "Password Installed" appears after you have successfully set your password.

The User Password item now shows **Installed**.

To change the user password, follow the same steps as in setting a user password.

Clear User Password

Select this item if you wish to clear the user password.

Password Check [Setup]

When set to [Setup], BIOS checks for user password when accessing the Setup utility. When set to [Always], BIOS checks for user password both when accessing Setup and booting the system. Configuration options:
[Setup] [Always]

4.7 Exit menu

The Exit menu items allow you to load the optimal or failsafe default values for the BIOS items, and save or discard your changes to the BIOS items.

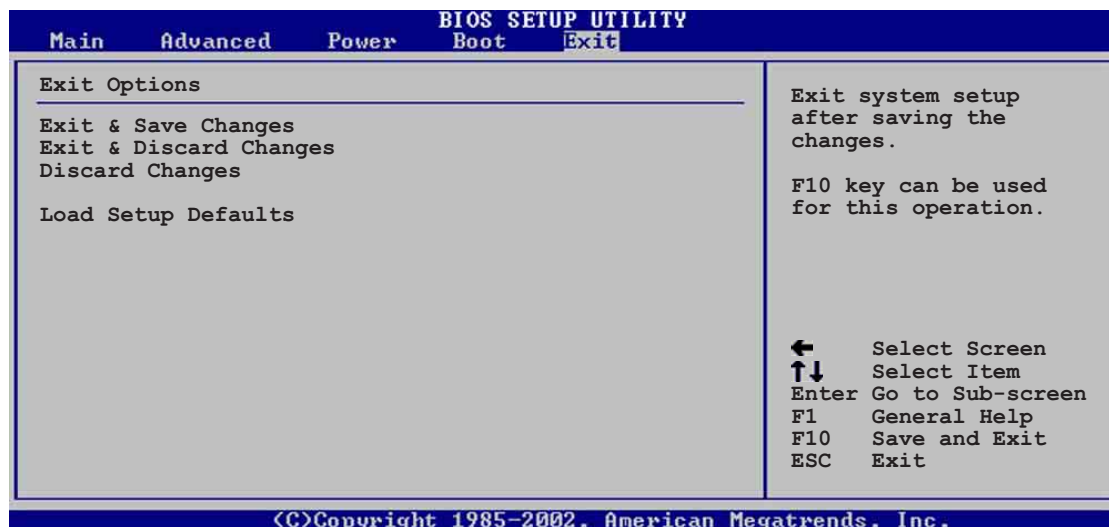

Pressing <Esc> does not immediately exit this menu. Select one of the options from this menu or <F10> from the legend bar to exit.

Exit & Save Changes

Once you are finished making your selections, choose this option from the Exit menu to ensure the values you selected are saved to the CMOS RAM. The CMOS RAM is sustained by an onboard backup battery and stays on even when the PC is turned off. When you select this option, a confirmation window appears. Select [Yes] to save changes and exit.



If you attempt to exit the Setup program without saving your changes, the program prompts you with a message asking if you want to save your changes before exiting. Pressing <Enter> saves the changes while exiting.

Exit & Discard Changes

Select this option only if you do not want to save the changes that you made to the Setup program. If you made changes to fields other than system date, system time, and password, the BIOS asks for a confirmation before exiting.

Discard Changes

This option allows you to discard the selections you made and restore the previously saved values. After selecting this option, a confirmation appears. Select [Yes] to discard any changes and load the previously saved values.

Load Setup Defaults

This option allows you to load the default values for each of the parameters on the Setup menus. When you select this option or if you press <F5>, a confirmation window appears. Select [Yes] to load default values. Select Exit Saving Changes or make other changes before saving the values to the non-volatile RAM.

Chapter 5

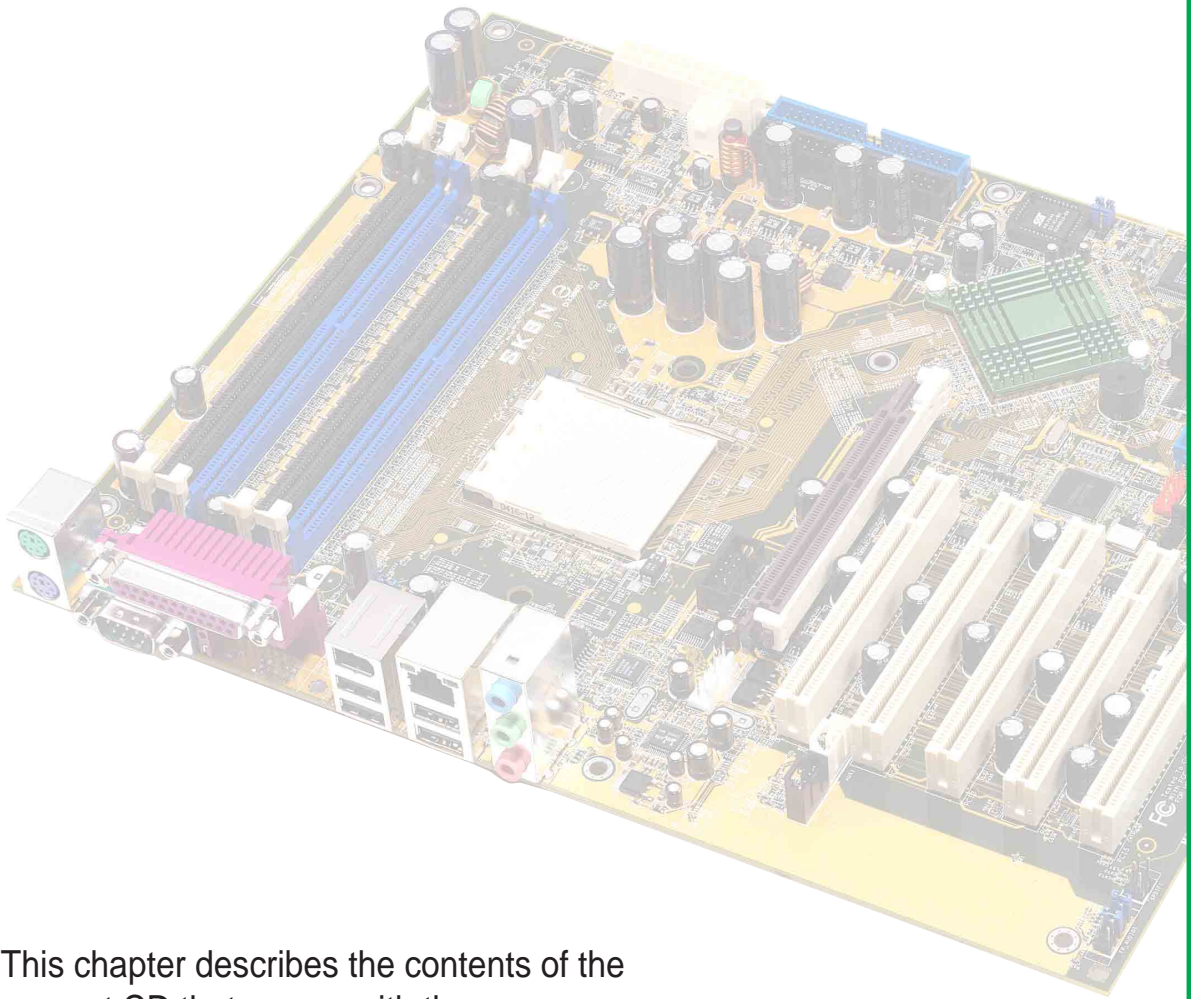

This chapter describes the contents of the support CD that comes with the motherboard package.

Software support

Chapter summary

5.1	Install an operating system	5-1
5.2	Support CD information	5-1
5.3	Software information	5-7
5.4	RAID configurations	5-17
5.5	Using Makedisk.exe	5-24

5.1 Install an operating system

This motherboard supports Windows 2000/Windows 2003 Server/XP operating system (OS). Always install the latest OS version and corresponding updates so you can maximize the features of your hardware.



Because motherboard settings and hardware options vary, use the setup procedures presented in this chapter for general reference only. Refer to your OS documentation for more information.

5.2 Support CD information

The support CD that came with the motherboard contains useful software and several utility drivers that enhance the motherboard features.



The contents of the support CD are subject to change at any time without notice. Visit the ASUS website for updates.

5.2.1 Running the support CD

To begin using the support CD, simply insert the CD into your CD-ROM drive. The CD automatically displays the **Drivers** menu if Autorun is enabled in your computer.

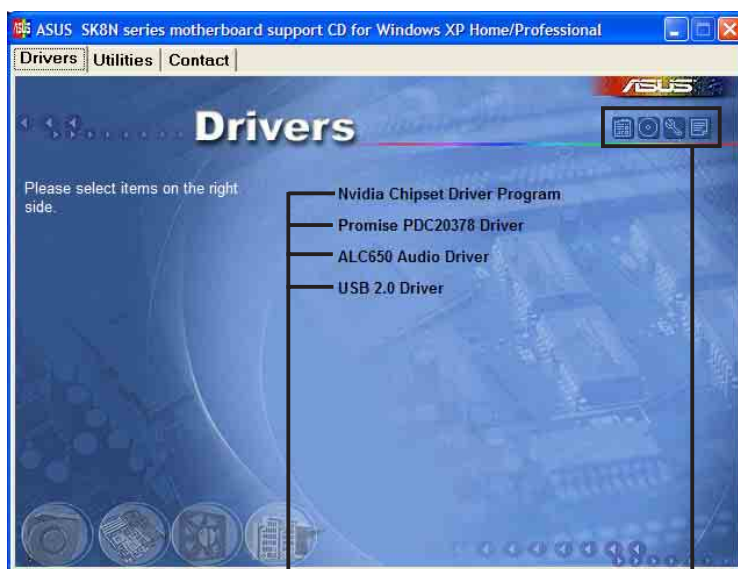

Click an item to install

Click an icon to display more information



If **Autorun** is NOT enabled in your computer, browse the contents of the support CD to locate the file **ASSETUP.EXE** from the **BIN** folder. Double-click the **ASSETUP.EXE** to run the CD.

5.2.2 Drivers menu

The drivers menu shows the available device drivers if the system detects installed devices. Install the necessary drivers to activate the devices.



Nvidia Chipset Driver Program

This item installs the Nvidia® Chipset drivers for the Nvidia nForce 3 Pro 150 chipset.

Promise PDC20378 Driver

This item installs the Promise PDC20378 driver for the ATA and Serial ATA RAID features.

ALC650 Audio Driver

This item installs the Realtek ALC650 audio driver and application.

USB 2.0 Driver

This item installs the Universal Serial Bus 2.0 driver.

5.2.3 Utilities menu

The Utilities menu shows the applications and other software that the motherboard supports.

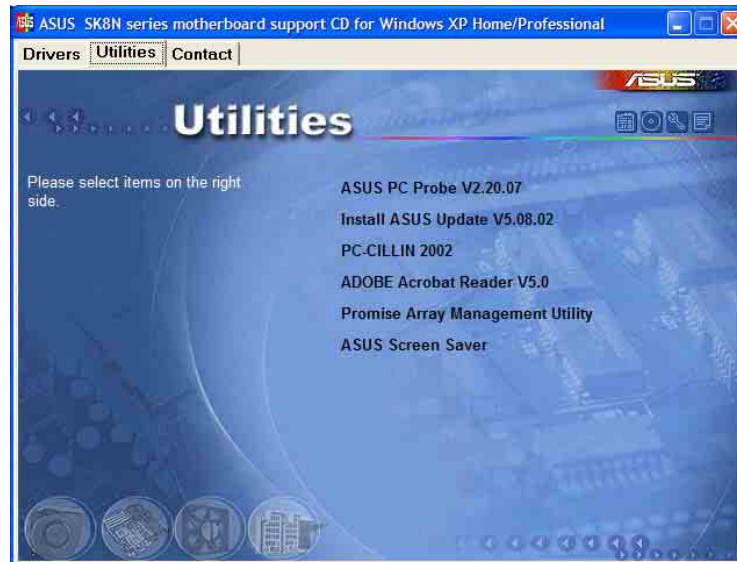

ASUS PC Probe

This smart utility monitors the fan speed, CPU temperature, and system voltages, and alerts you on any detected problems. This utility helps you keep your computer at a healthy operating condition.

Install ASUS Update

This program allows you to download the latest version of the BIOS from the ASUS website.



Before using the ASUS Update, make sure that you have an Internet connection so you can connect to the ASUS website.

PC-CILLIN 2002

This item installs the PC-cillin 2002 anti-virus program. View the PC-cillin online help for detailed information.

Adobe Acrobat Reader V5.0

This item installs the Adobe Acrobat Reader V5.0. The Acrobat Reader software is for viewing files saved in Portable Document Format (PDF).

Promise Array Management Utility

This item installs the Promise Array Management software utility.

ASUS Screen Saver

This item installs the ASUS screen saver.



Screen display and utilities option may not be the same for other operating system versions.

5.2.4 ASUS Contact Information

Clicking the ASUS Contact Information tab displays as stated. You may also find this information on page x of this user guide.



5.2.5 Other information

The icons on the top right corner of the screen give additional information on the motherboard and the contents of the support CD. Click an icon to display the specified information.

Motherboard Info

The window displays the general specifications of the SK8N motherboard.

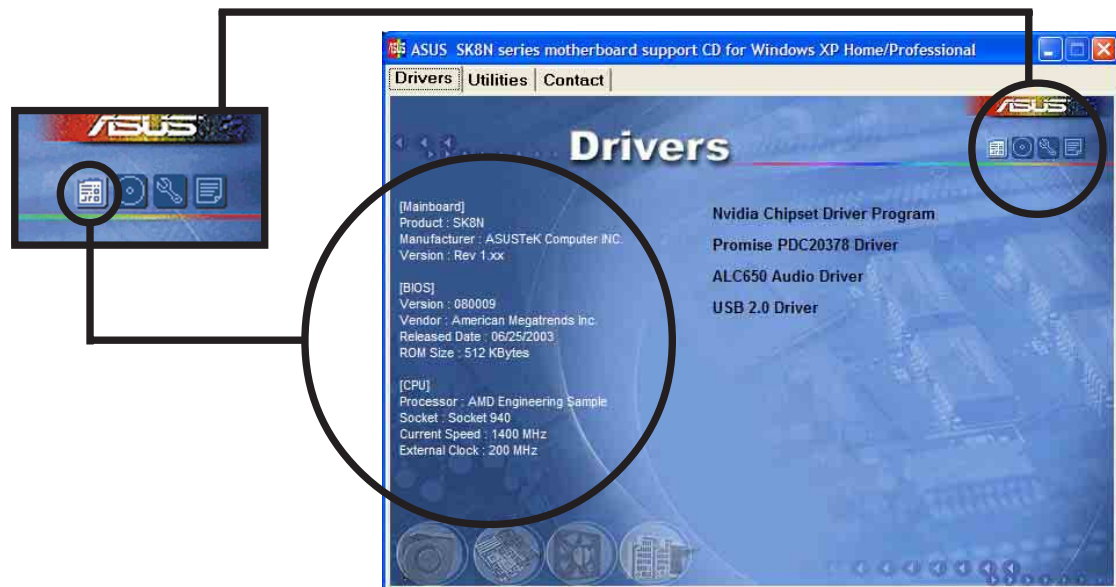

Browse this CD

The window displays the support CD contents in graphical format.

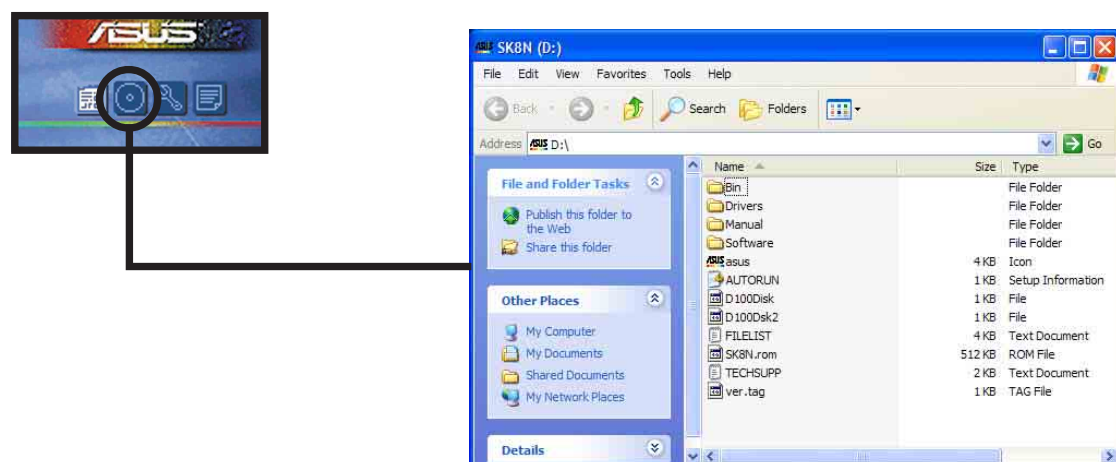

Technical Support Form

The window displays the ASUS Technical Support Request Form that you have to fill up when requesting technical support.

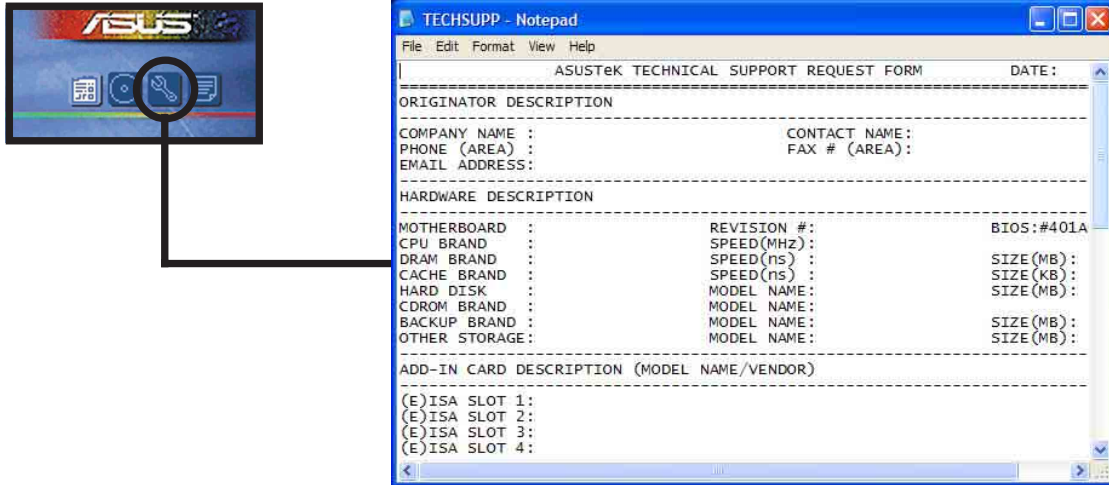

Filelist

The window displays the contents of the support CD and a brief description of each in text format.

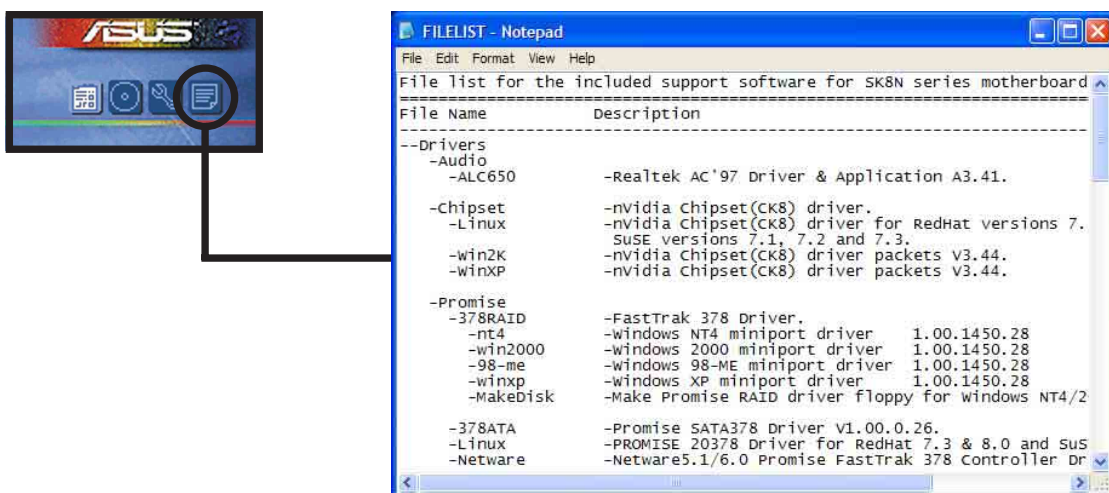

5.3 Software information

Most of the applications in the support CD have wizards that will conveniently guide you through the installation. View the online help or readme file that came with the software for more information.

This section provides details on the software applications that the motherboard supports.

5.3.1 ASUS Update

The ASUS Update is a utility that allows you to update the motherboard BIOS and drivers. This utility requires an Internet connection either through a network or an Internet Service Provider (ISP).

Follow these steps to use the ASUS Update.

1. Launch the utility from your Windows Start menu:

**Programs/AsusUpdate Vx.xx.xx/
AsusUpdate**

The ASUS Update initial screen appears.

2. Select your desired update method, then click Next.

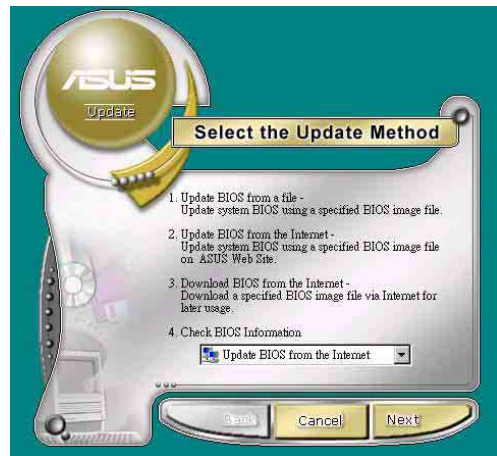

3. If you selected updating/downloading from the Internet, select the ASUS FTP site nearest you to avoid network traffic, or choose Auto Select. Click Next.

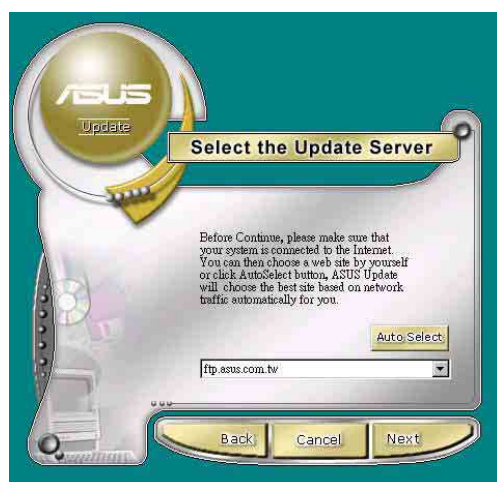

- From the FTP site, select the BIOS version that you wish to download. Click Next.
- Follow the instructions on the succeeding screens to complete the update process.

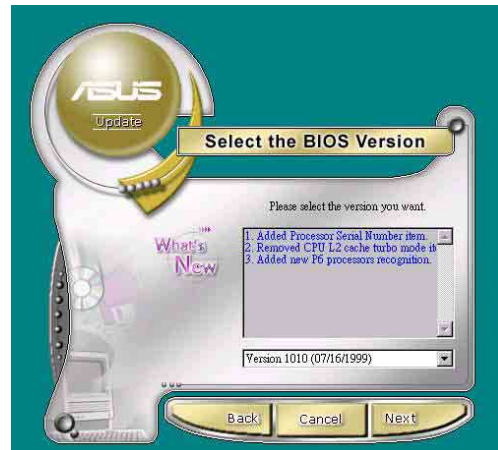

If you selected the option to update the BIOS from a file, a window pops up prompting you to locate the file. Select the file, click Save, then follow the screen instructions to complete the update process.

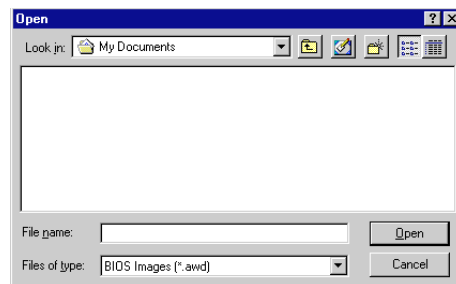

5.3.2 ASUS MyLogo2™

The ASUS MyLogo2™ is automatically installed when you install the ASUS Update utility from the software menu. See section “5.2.3 Utilities menu”.

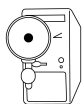

Before using ASUS MyLogo2™ feature, use the AFUDOS utility to make a copy of your original BIOS file, or obtain the latest BIOS version from the ASUS website.



Make sure that the BIOS Item Full Screen Logo is set to [Enabled] if you wish to use ASUS MyLogo2. See page 4-30.

Follow these steps to use ASUS MyLogo2.

- Launch the ASUS Update utility. See section “5.3.1 ASUS Update.”
- When prompted for the BIOS update method, select the option “Update BIOS from a file.”
- Specify the location of the BIOS file, such as from a floppy disk. Click Next.



- From the selection that appears, choose a logo image. Click Next.



If you wish, you may create your own boot logo image in GIF, JPG, or BMP file formats.



- When you click on an image, it displays larger on the MyLogo2 screen.



If you wish to make the logo image smaller, click on the arrow on the Ratio item and select your desired scale.



- The next screen prompts you to flash the original BIOS to update it with the new boot logo. Click Flash to update the BIOS.
- When finished, click Exit, then reboot your computer. Your system boots with the new boot logo.

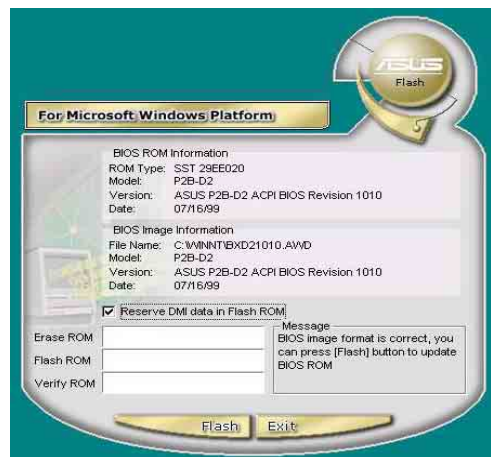

Instead of starting from ASUS Update, you may also launch ASUS MyLogo2 directly from the Windows Start menu to change your BIOS boot logo. After you have modified the BIOS file with the new logo, use the ASUS Update utility to upload the new BIOS.

5.3.3 ASUS PC Probe

The ASUS PC Probe is a convenient utility to continuously monitor your computer system's vital components, such as fan rotations, voltages, and temperatures. It also has the DMI Explorer utility that lets you review useful information about your computer, such as hard disk space, memory usage, and CPU type, CPU speed, and internal/external frequencies.

Starting ASUS PC Probe

When ASUS PC Probe starts, a splash screen appears allowing you to select whether to show the screen again when you open PC Probe or not. To bypass this startup screen, clear the **Show up in next execution** check box.

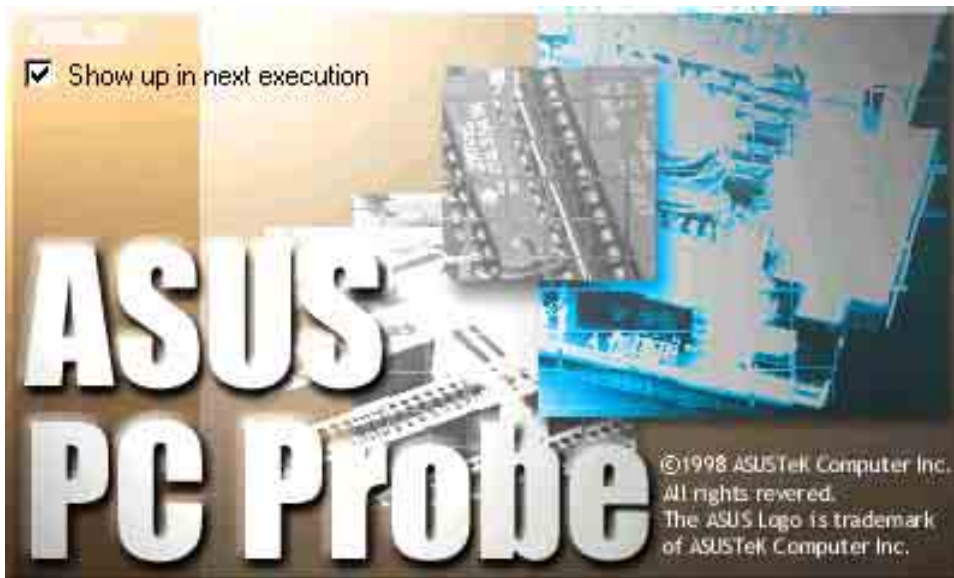

To launch **ASUS PC Probe**, click the Windows **Start** button, point to **Programs**, and then **ASUS Utility**, and then click **Probe Vx.xx**.

The PC Probe icon  appears on the taskbar system tray indicating that ASUS PC Probe is running. Clicking the icon allows you to see the status of your PC.

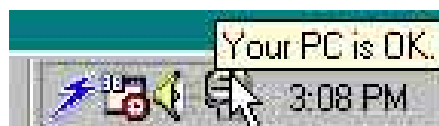

Using ASUS PC Probe

Monitoring

Monitor Summary

Shows a summary of the items being monitored.

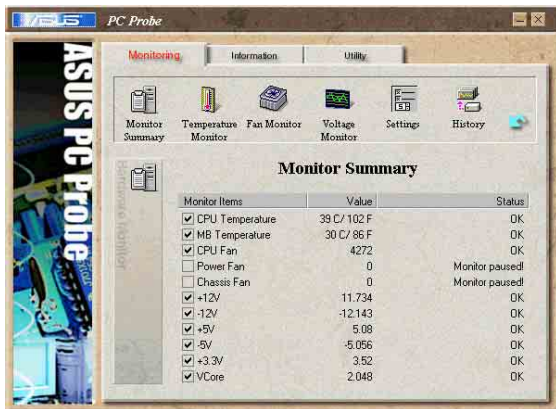

Temperature Monitor

Shows the PC temperature (for supported processors only).

Temperature Warning threshold adjustment
(Move the slider up to increase the threshold level or down to decrease the threshold level)

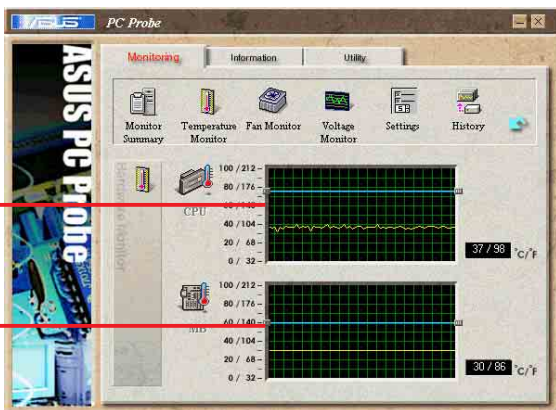

Fan Monitor

Shows the PC fan rotation.

Fan Warning threshold adjustment
(Move the slider up to increase the threshold level or down to decrease the threshold level)

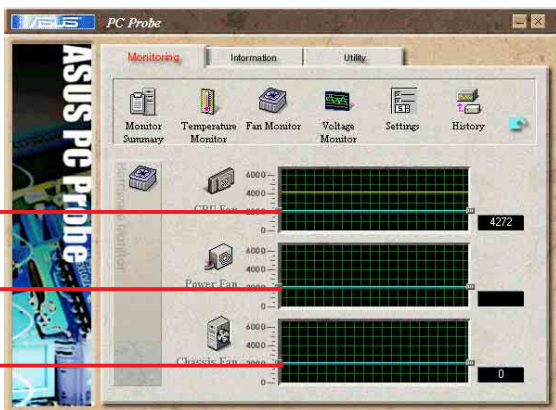

Voltage Monitor

Shows the PC voltages.

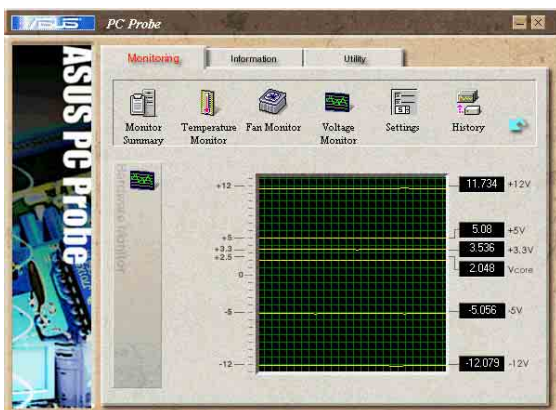

Settings

Lets you set threshold levels and polling intervals or refresh times of the PC's temperature, fan rotation, and voltages.



CPU Cooling System Setup
Lets you select when to enable software CPU cooling. When **When CPU Overheated** is selected, the CPU cooling system is enabled whenever the CPU temperature reaches the threshold value.



History

Lets you record the monitoring activity of a certain component of your PC for future reference.

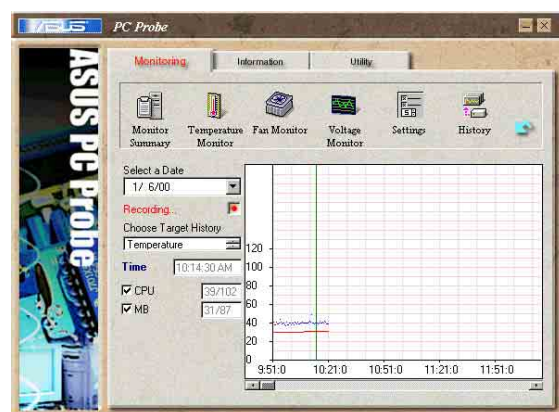

Fan Control

Lets you enable/disable Smart Fan Control. Smart Fan Control adjusts the fan speed automatically based on the current CPU temperature and predefined threshold.

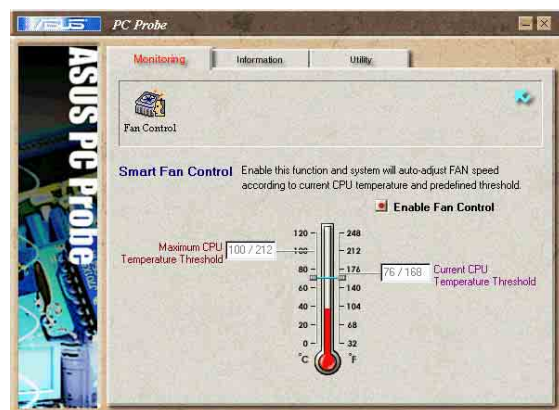

Hard Drives

Shows the used and free space of the PC's hard disk drives and the file allocation table or file system used.

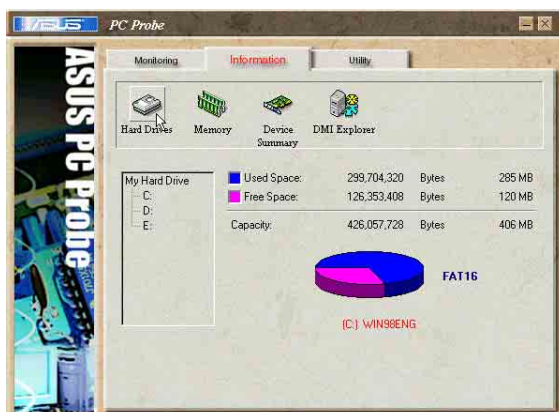

Information

Memory

Shows the PC memory load, memory usage, and paging file usage.

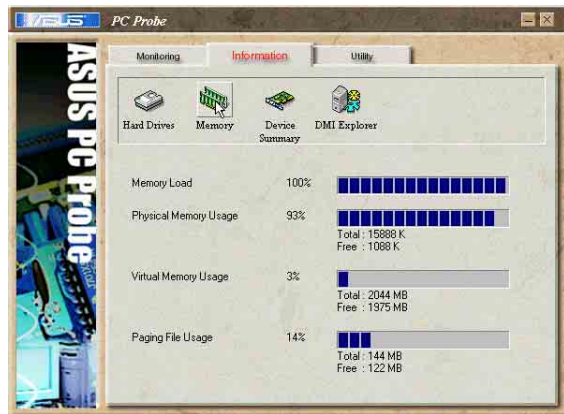

Device Summary

Shows a summary of devices present in your PC.

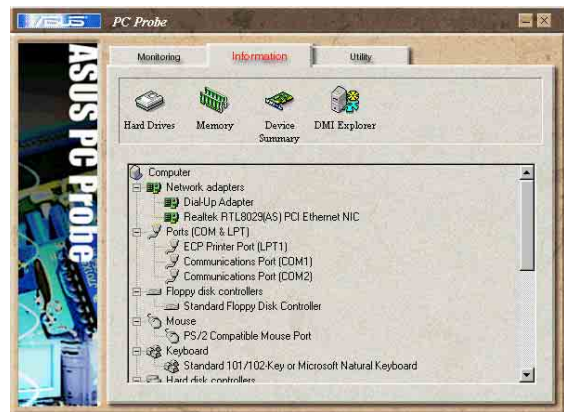

DMI Explorer

Shows information pertinent to the PC, such as CPU type, CPU speed, and internal/external frequencies, and memory size.

The screenshot shows the 'DMI Explorer' section of the ASUS PC Probe Information tab. It displays a table of system information:

	Name	Property
BIOS	Vendor	Award Software, Inc.
System	Version	ASUS P3B-F ACPI BIOS P...
Motherboard	Starting Address	F000
Chassis	Release Date	08/07/1999
Processor	ROM Size	256K
Memory Controller	ISA	Supported
Cache	MCA	Not Supported
Port Connector	EISA	Not Supported
System Slots	PCI	Supported
OEM Information	PCMCIA	Not Supported
System Configuration	PrnP	Supported
BIOS Language	APM	Supported
	BIOS is Upgradeable	Supported
	BIOS Shadowing	Supported
	VL-VESA	Not Supported

Utility

Lets you run programs outside of the ASUS Probe modules. To run a program, click **Execute Program**. **NOTE:** This feature is currently unavailable.

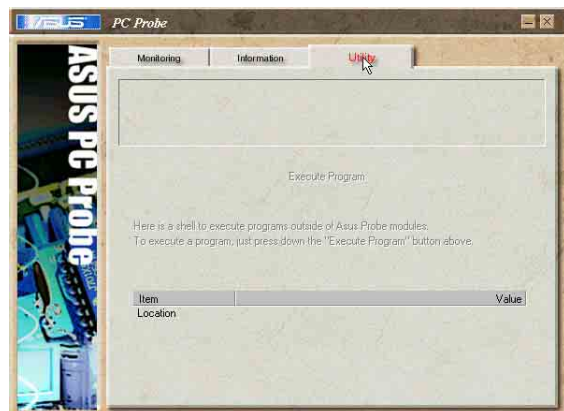

ASUS PC Probe Task Bar Icon

Right clicking the PC Probe icon brings up a menu to open or exit ASUS PC Probe and pause or resume all system monitoring.



When the ASUS PC Probe senses a problem with your PC, portions of the ASUS PC Probe icon change to red, the PC speaker beeps, and the ASUS PC Probe monitor appears.



5.3.6 Multi-Channel Audio Feature

The RealTek ALC650 6-channel AC'97 Audio Driver and Applications are included in the support CD that came with your motherboard package. Install these programs to enable the multi-channel audio feature.



You must use 4 or 6 channel speakers for this setup.

Setting the RealTek ALC650 AC'97 Audio Configuration

1. Install the RealTek ALC650 AC'97 audio driver from the support CD.

2. After installation, the RealTek "Sound Effect" icon appears on the bottom right of the screen.



Sound Effect Icon

3. Click on the Sound Effect icon to display the RealTek ALC650 AC97 Audio Configuration dialogue box. Transform the sound environment, set to Karaoke or load the Equalizer from the **Sound Effect** tab.

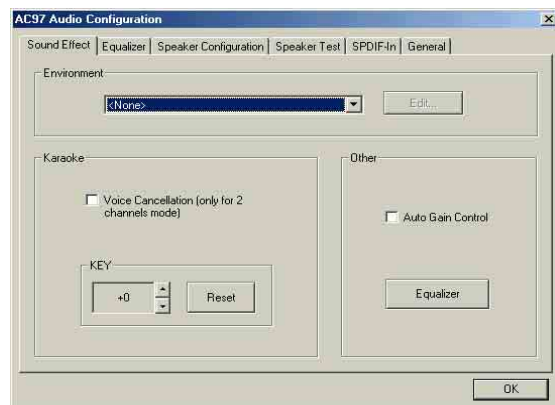

You may also launch the ALC650 AC97 Audio Application by clicking on the **Start** button on your Windows desktop, then select **Programs > Audio Sound Manager > SoundMan**

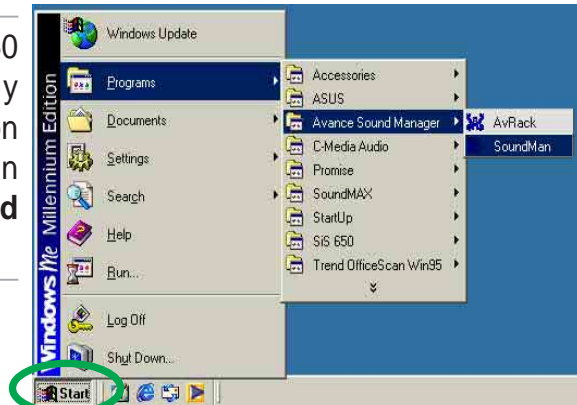

4. Click on the **Equalizer** tab to display panel to individually control frequency bands and adjust sound output.



You may also display the **Equalizer** panel by clicking on the Equalizer command button on the Sound Effect tab.

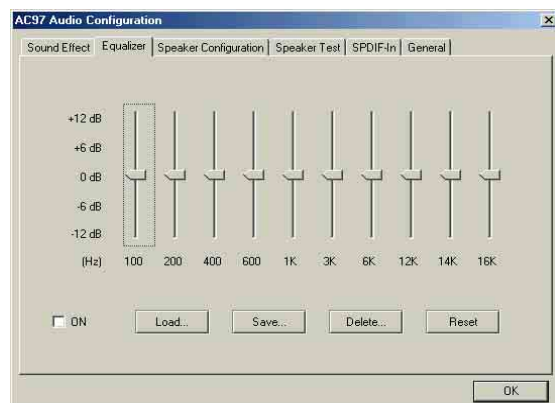

- Click on the **Speaker Configuration** tab to customize your speaker system.



Make sure to select the correct speaker channel mode based on your actual speaker setup.



- Click on the **Speaker Test** tab for the Multi-channel audio test.



When you use the 6-channel function and your speaker Center/Subwoofer channel is incorrect, select **Swap Center/ Subwoofer Output**.



- Click on the **General** tab for version information and multi-language settings.



English is the default setting when you first install the audio programs package.

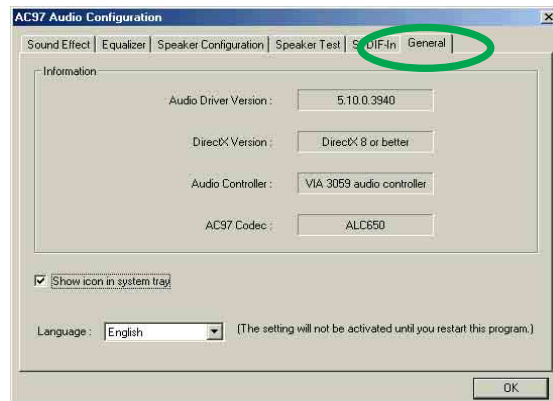

Connector Settings and Functions

Connector	Headphone/2 Speaker	4-Speaker	6-Speaker
Lime	Line Out/ Front Speaker Out	Line Out/ Front Speaker Out	Line Out/ Front Speaker Out
Light Blue	Line In	Rear Speaker Out	Rear Speaker Out
Pink	Mic In	Mic In	Center Speaker Out, Sub-woofer

5.4 RAID configurations

The motherboard includes the Promise® PDC20378 controller chipset to support Redundant Array of Independent Disks (RAID) configurations. Using two Serial ATA hard disks on SATA_RAID1/SATA_RAID2 interfaces, and two ATA133 hard disks on the PRI_RAID interface, you may set up RAID 0, RAID 1 and RAID 0+1 configurations. Use the MBFastTrak378™ BIOS and the FastBuild™ utility to configure a disk array.

RAID 0 (called *data striping*) optimizes two identical hard disk drives to read and write data in parallel, interleaved stacks. Two hard disks perform the same work as a single drive but at a sustained data transfer rate, double that of a single disk alone, thus improving data access and storage.

RAID 1 (called *data mirroring*) copies and maintains an identical image of data from one drive to a second drive. If one drive fails, the disk array management software directs all applications to the surviving drive as it contains a complete copy of the data in the other drive. This RAID configuration provides data protection and increases fault tolerance to the entire system.

RAID 0+1 is *data striping* and *data mirroring* combined without parity (redundancy data) having to be calculated and written. The advantage of RAID 0 + 1 is fast data access (like RAID 0), but with the ability to lose one drive and have a complete duplicate surviving drive or set of drives (like RAID 1).

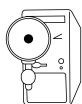

-
- Make sure to create a floppy disk with the Promise® 378ATA / 378SATA RAID driver using the Makedisk.exe utility before installing Windows® XP™ or 2000™ operating systems. See page 5-25 for details.
 - Refer to the **FastTrak 378 Quick Start Guide** and **SATA Quick Start Guide** found in “/Manual” of the support CD for detailed information on RAID configurations under different operating systems.
-

5.4.1 Install the hard disks

The PDC20378 chipset supports Ultra ATA/133/100/66 hard disk drives. For optimal performance, install identical drives of the same model and capacity when creating a disk array.

- If you are creating a **RAID 0 (striping)** array for performance, use two new drives.
- If you are creating a **RAID 1 (mirroring)** array for protection, you can use two new drives or use an existing drive and a new drive (the new drive must be of the same size or larger than the existing drive).

Follow these steps to install the hard disks for RAID configuration.

1. Set the jumpers of each hard disk as Master/Slave.
2. Install the hard disks into the drive bays.
3. Connect the HDD cables. These connection options are available for creating a RAID 0 or RAID 1 array:
 - a) Connect two Parallel ATA HDDs to PRI_RAID connector and one Serial ATA HDD to either one of the two Serial ATA connectors, using separate parallel ATA or serial ATA cables.
 - b) Connect one Serial ATA HDD to each Serial ATA connector, using separate serial ATA cables.
4. Connect the power cable to the power connector on each drive.
5. Boot the system and enter the BIOS Setup Utility.
6. Go to the **Advanced** menu in BIOS and set the appropriate IDE configuration settings.
7. Save your changes and Exit Setup.
8. Proceed to section 5.4.2 for the next procedure.

5.4.2 Enter the MBFastBuild™ utility

1. Boot the system.

If this is the first time you boot the system with the new hard disks installed and connected to the ATAIDE connectors on the motherboard, the MBFastTrak378™ BIOS displays the following:

```
MBFastTrak378 (tm) BIOS version 1.00
(c)2000-2005 Promise Technology, Inc. All Rights Reserved.

No Array defined...

Press <Ctrl-F> to enter FastBuild (tm) Utility
Or press <ESC> key to continue booting.
```

2. Press <Ctrl-F> simultaneously to display the FastBuild™ utility main menu.

```
FastBuild (tm) Utility 2.00 (c) 2002-2005 Promise Technology, Inc.
[ Main Menu ]

Auto Setup . . . . . [ 1 ]
View Drive Assignments . . . . [ 2 ]
Define Array . . . . . [ 3 ]
Delete Array . . . . . [ 4 ]
Rebuild Array. . . . . [ 5 ]

[ Keys Available ]

Press 1..5 to select Option [ESC] Exit
```

5.4.3 Creating a RAID 0 array (Performance)

1. In the FastBuild™ utility main menu, press “1” to select Auto Setup. The following screen appears.

```
FastBuild (tm) Utility 2.00 (c) 2002-2005 Promise Technology, Inc.
[ Auto Setup Options Menu ]
Optimize Array for: Performance
[ Array Setup Configuration ]
Mode ..... Stripe
Spare Drive..... 0
Drive(s) Used in Array..... 2
Array Disk Capacity (size in MB)..... 8650
[ Keys Available ]
[ ↑ ] Up [ ↓ ] Down [ ←,→,Space ] Change Option [ ESC ] Exit [ CTRL-Y ] Save
```

2. Use the arrow keys to go to the field **Optimize Array for** and select “Performance” with the space bar. The **Mode** field displays “Stripe”.
3. After making a selection, press <Ctrl-Y> to save and create a RAID 0 array.
4. Press any key to reboot the system. During the boot process, the MBFastTrak378 BIOS checks and displays the disk array information.

```
MBFastTrak376 (tm) BIOS Version 1.00
(c) 2000-2005 Promise Technology, Inc. All Rights Reserved.
ID      MODE      SIZE      TRACK-MAPPING      STATUS
-----
1*      2+0 Stripe  3257M     723/192/48         Functional
Press <Ctrl-F> to enter FastBuild (tm) Utility
```

5. Once the array is created, use the FDISK utility to format the array as a single hard drive.
6. After you have formatted the arrayed drives, install an operating system (OS). The OS will treat the RAID 0 array as a single drive unit.
7. Install the RAID driver from the support CD that came with the motherboard package.

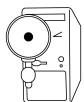

Depending on the operating system you are installing, you may need to install the RAID driver during or after the OS installation.

5.4.4 Creating a RAID 1 array (Security)

Creating a Security Array with New Drives

1. In the FastBuild™ utility main menu, press “1” to select Auto Setup.

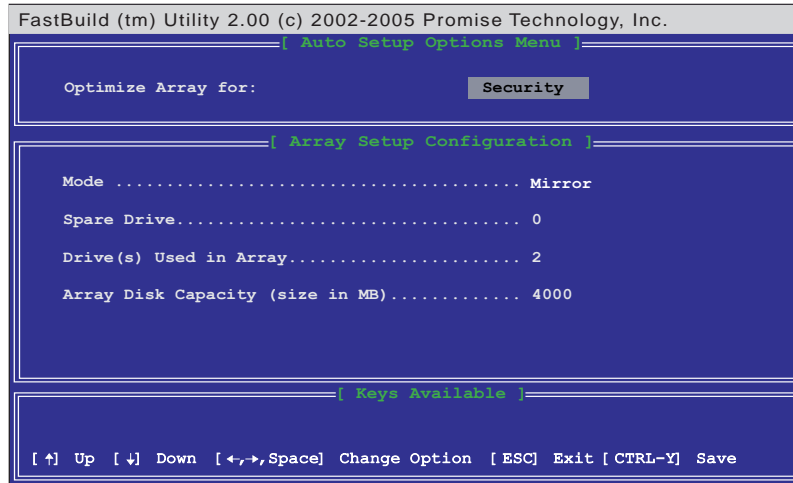

2. Use the arrow keys to go to the field **Optimize Array for** and select “*Security*” with the space bar. The **Mode** field displays “*Mirror*”.
3. Press <Ctrl-Y> to save your selection.
4. The following message appears:

```
Do you want the disk image to be duplicated to another? (Yes/No)
Y - Create and Duplicate
N - Create Only
```

5. Press **N** for the *Create Only* option. A message appears confirming that your Security array has been created.

```
Array has been created.
<Press any key to reboot>
```

6. Press any key to reboot the system. During the boot process, the MBFastTrak376 BIOS checks and displays the disk array information.



7. Use the FDISK utility and follow the format procedure for installing a new hard drive. After you have formatted the arrayed drives, install an operating system (OS).
8. Install the RAID driver from the support CD that came with the motherboard package.

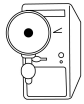

Depending on the operating system you are installing, you may need to install the RAID driver during or after the OS installation.

Creating a Security Array with Existing Data Drive

If you would like to use an existing drive that already contains data and/or is the bootable drive in your system, make sure that the new hard drive you will use in the array has the same or larger capacity as the existing drive.



Backup all important data before creating an array. Failure to do so may cause data loss.

1. In the FastBuild™ utility main menu, press “1” to select Auto Setup.
2. Use the arrow keys to go to the field **Optimize Array for** and select “Security” with the space bar. The **Mode** field displays “Mirror”.
3. Press <Ctrl-Y> to save your selection. The following message appears:

```
Do you want the disk image to be duplicated to another? (Yes/No)

Y - Create and Duplicate
N - Create Only
```

5. Press **Y** for the *Create and Duplicate* option. The next window prompts you to select the source drive to use.
6. Use the arrow keys to select the source drive. The FastBuild utility will copy all the data from the source drive to the target drive.
7. Press <Ctrl-Y> to save the selection and start the duplication. The following message appears:

```
Start to duplicate the image...
Do you want to continue? (Yes/No)

Y - Continue    N - Abort
```

8. Select **Y** to continue. Select **N** to return to the main menu.
9. When the duplication process is completed, a message appears confirming that your Security array has been created.
10. Press any key to reboot the system.
11. Install the RAID driver from the support CD that came with the motherboard package.

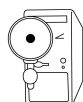

Depending on the operating system you are installing (or that is already installed), the RAID driver installation sequence may vary.

5.4.5 Other FastBuild Utility Commands

Command options 3-6 on the FastBuild™ Utility main menu are not required for setting up an array, but they are useful for reconfiguring an array.

View Array (3): This command allows you to view the drive assignments of hard disks in an array.

Delete Array (4): This command deletes an array to reconfigure the system. Deleting an array does not remove information on the hard disks. If an array is deleted by mistake, recover it immediately by redefining it as the deleted array.

Rebuild Array (5): This command restores the array and system data after faults on RAID 1 arrays.

Follow these steps to rebuild and restore data in the array:

1. On boot-up, an error message notifies of a system failure.
2. Press <**Ctrl-F**> to enter the FastBuild™ Main Menu.
3. Select <3> for View Array to verify the ID of the defunct hard disk.
4. Power off the system and replace the hard disk with an identical model.
5. Reboot and enter the FastBuild™ Main Menu again.
6. Select <5> for Rebuild Array. The malfunctioning array is highlighted. Press **Enter** to select.

```
FastBuild (tm) Utility 2.00 (c) 2002-2005 Promise Technology, Inc.
[ Rebuild Array Menu ]

  Array No   RAID Mode   Total Drv   Capacity   Status
-----
  Array 1    Mirror/Stripe   4           7999      Critical
  Array 2    -----
  Array 3    -----
  Array 4    -----

[ Keys Available ]

[ ↑ ] Up [ ↓ ] Down [ ESC ] Exit [ Enter ] Select
```

7. Select the replacement drive. Press <Enter>.

```
FastBuild (tm) Utility 2.00 (c) 2002-2005 Promise Technology, Inc.
[ View Array Definition Menu ]

  Array No   RAID Mode   Total Drv   Status
-----
  Array 1    Mirror/Stripe   4           Critical

  Stripe Block: Not Available           Gigabyte Boundary: ON

[ Select Drive for Rebuild ]

  Channel: ID      Drive Model      Capacity (MB)
-----
  3:Mas FUJITSU MPD3043AT      4325

[ Keys Available ]

[ ↑ ] Up [ ↓ ] Down [ ESC ] Exit [ Enter ] Select
```

8. Confirm the command to copy data from the intact source hard disk onto a new replacement hard disk. A progress gauge displays the copy progress for the duration of the task.
9. After the rebuild process is complete, the user is prompted to reboot the system.

Controller Configuration (6): This command shows the default for Controller Configuration. The default value is [Enabled].

5.5 Using Makedisk.exe

Important Notes

1. The Makedisk.exe utility enables you to create a floppy disk with the RAID driver necessary when configuring RAID installations.
2. The Makedisk.exe utility for the Promise® SATA 378 driver is located in “\Drivers\Promise\378ATA\Makedisk.exe” of the support CD.
3. The Makedisk.exe utility for the FastTrak 376/378 driver is located in “\Drivers\Promise\378RAID\Makedisk.exe” of the support CD.



A floppy disk with Promise® SATA 378 or FastTrak 376/378 driver is required when installing Windows® XP™/ 2000™ or NT™ operating systems. Make sure to create a RAID driver floppy disk using Makedisk.exe utility for the Promise® ATA/SATA RAID function before installing your operating system.

4. During the OS installation, press the “F6” key and insert the created driver floppy disk to upload RAID driver.



Write-protect the floppy disk to avoid computer virus infection.
