

A8N-SLI

Premium

ASUS[®]

Motherboard

E2435

**Revised Edition V3
February 2006**

Copyright © 2006 ASUSTeK COMPUTER INC. All Rights Reserved.

No part of this manual, including the products and software described in it, may be reproduced, transmitted, transcribed, stored in a retrieval system, or translated into any language in any form or by any means, except documentation kept by the purchaser for backup purposes, without the express written permission of ASUSTeK COMPUTER INC. (“ASUS”).

Product warranty or service will not be extended if: (1) the product is repaired, modified or altered, unless such repair, modification or alteration is authorized in writing by ASUS; or (2) the serial number of the product is defaced or missing.

ASUS PROVIDES THIS MANUAL “AS IS” WITHOUT WARRANTY OF ANY KIND, EITHER EXPRESS OR IMPLIED, INCLUDING BUT NOT LIMITED TO THE IMPLIED WARRANTIES OR CONDITIONS OF MERCHANTABILITY OR FITNESS FOR A PARTICULAR PURPOSE. IN NO EVENT SHALL ASUS, ITS DIRECTORS, OFFICERS, EMPLOYEES OR AGENTS BE LIABLE FOR ANY INDIRECT, SPECIAL, INCIDENTAL, OR CONSEQUENTIAL DAMAGES (INCLUDING DAMAGES FOR LOSS OF PROFITS, LOSS OF BUSINESS, LOSS OF USE OR DATA, INTERRUPTION OF BUSINESS AND THE LIKE), EVEN IF ASUS HAS BEEN ADVISED OF THE POSSIBILITY OF SUCH DAMAGES ARISING FROM ANY DEFECT OR ERROR IN THIS MANUAL OR PRODUCT.

SPECIFICATIONS AND INFORMATION CONTAINED IN THIS MANUAL ARE FURNISHED FOR INFORMATIONAL USE ONLY, AND ARE SUBJECT TO CHANGE AT ANY TIME WITHOUT NOTICE, AND SHOULD NOT BE CONSTRUED AS A COMMITMENT BY ASUS. ASUS ASSUMES NO RESPONSIBILITY OR LIABILITY FOR ANY ERRORS OR INACCURACIES THAT MAY APPEAR IN THIS MANUAL, INCLUDING THE PRODUCTS AND SOFTWARE DESCRIBED IN IT.

Products and corporate names appearing in this manual may or may not be registered trademarks or copyrights of their respective companies, and are used only for identification or explanation and to the owners’ benefit, without intent to infringe.

Contents

Notices	viii
Safety information	ix
About this guide.....	x
How this guide is organized.....	x
Where to find more information	xi
Conventions used in this guide.....	xi
Typography	xi
A8N-SLI Premium specifications summary	xii

Chapter 1: Product introduction

1.1	Welcome!	1-1
1.2	Package contents	1-1
1.3	Special features	1-2
1.3.1	Product highlights.....	1-2
1.3.2	ASUS Proactive features	1-5
1.3.3	Innovative ASUS features	1-6

Chapter 2: Hardware information

2.1	Before you proceed	2-1
2.2	Motherboard overview	2-2
2.2.1	Placement direction	2-2
2.2.2	Screw holes.....	2-2
2.2.3	Motherboard layout	2-3
2.2.4	Layout Contents	2-4
2.3	Central Processing Unit (CPU)	2-6
2.3.1	Overview	2-6
2.3.2	Installing the CPU	2-6
2.3.3	Installing the heatsink and fan	2-8
2.4	System memory.....	2-11
2.4.1	Overview	2-11
2.4.2	Memory Configurations	2-11
2.4.3	Installing a DIMM	2-14
2.4.4	Removing a DIMM.....	2-14
2.5	Expansion slots	2-15
2.5.1	Installing an expansion card	2-15
2.5.2	Configuring an expansion card	2-15

Contents

- 2.5.3 Interrupt assignments..... 2-16
- 2.5.4 PCI slots 2-16
- 2.5.5 Two PCI Express x16 slots..... 2-17
- 2.5.6 PCI Express x1 slot 2-17
- 2.5.7 Universal PCIe slot (PCI Express x4 slot) 2-17
- 2.6 Jumpers 2-18
- 2.7 Connectors 2-19
 - 2.7.1 Rear panel connectors 2-19
 - 2.7.2 Internal connectors..... 2-21

Chapter 3: Powering up

- 3.1 Starting up for the first time 3-1
- 3.2 Powering off the computer..... 3-2
 - 3.2.1 Using the OS shut down function 3-2
 - 3.2.2 Using the dual function power switch..... 3-2
- 3.3 ASUS POST Reporter™ 3-3
 - 3.3.1 Vocal POST messages..... 3-3
 - 3.3.2 Winbond Voice Editor 3-5

Chapter 4: BIOS setup

- 4.1 Managing and updating your BIOS 4-1
 - 4.1.1 Creating a bootable floppy disk 4-1
 - 4.1.2 Updating the BIOS..... 4-2
 - 4.1.3 Saving the current BIOS file 4-4
 - 4.1.4 ASUS CrashFree BIOS 2 utility 4-5
 - 4.1.5 ASUS EZ Flash utility 4-7
 - 4.1.6 ASUS Update utility 4-8
- 4.2 BIOS setup program..... 4-11
 - 4.2.1 BIOS menu screen..... 4-12
 - 4.2.2 Menu bar 4-12
 - 4.2.3 Legend bar..... 4-13
 - 4.2.4 Menu items 4-13
 - 4.2.5 Sub-menu items..... 4-13
 - 4.2.6 Configuration fields..... 4-13
 - 4.2.8 General help 4-14
 - 4.2.7 Pop-up window..... 4-14

Contents

4.3	Main menu.....	4-15
4.3.1	System Time	4-15
4.3.2	System Date	4-15
4.3.3	Language	4-15
4.3.4	Legacy Diskette A	4-15
4.3.5	Primary and Secondary IDE Master/Slave	4-16
4.3.5	First, Second, Third, Fourth SATA Master	4-18
4.3.7	HDD SMART Monitoring.....	4-19
4.3.8	Installed Memory	4-19
4.4	Advanced menu	4-20
4.4.1	CPU Configuration	4-20
4.4.2	PCInP	4-23
4.4.3	Onboard Devices Configuration.....	4-24
4.4.4	SLI Configuration.....	4-29
4.4.5	JumperFree Configuration.....	4-30
4.4.6	LAN Cable Status.....	4-32
4.4.7	PEG Link Mode.....	4-33
4.4.8	Speech Configuration.....	4-34
4.4.9	Instant Music.....	4-34
4.5	Power menu	4-35
4.5.1	ACPI Suspend Type	4-35
4.5.2	ACPI APIC Support	4-35
4.5.3	APM Configuration	4-36
4.5.4	Hardware Monitor.....	4-38
4.6	Boot menu	4-40
4.6.1	Boot Device Priority	4-40
4.6.3	Hard Disk Drives.....	4-41
4.6.2	Removable Drives.....	4-41
4.6.4	CDROM Drives	4-42
4.6.5	Boot Settings Configuration	4-42
4.6.6	Security.....	4-44
4.7	Exit menu.....	4-46

Chapter 5: Software support

5.1	Installing an operating system.....	5-1
-----	-------------------------------------	-----

Contents

- 5.2 Support CD information 5-1
 - 5.2.1 Running the support CD 5-1
 - 5.2.2 Drivers menu 5-2
 - 5.2.3 Utilities menu 5-3
 - 5.2.4 Manuals menu 5-5
 - 5.2.5 ASUS Contact information 5-6
 - 5.2.6 Other information 5-6
- 5.4 Software information 5-9
 - 5.4.1 ASUS MyLogo2™ 5-9
 - 5.4.2 AI NET 2 5-11
 - Using the Virtual Cable Tester™ 5-11
 - 5.4.3 Audio configurations 5-12
 - 5.4.4 Using the NVIDIA® Firewall™ 5-18
- 5.5 RAID configurations 5-21
 - 5.5.1 Installing hard disks 5-22
 - 5.5.2 NVIDIA® RAID configurations 5-23
 - 5.5.3 Silicon Image RAID configurations 5-30
- 5.6 Creating a RAID driver disk 5-40
- 5.7 Cool ‘n’ Quiet!™ Technology 5-41
 - 5.7.1 Enabling Cool ‘n’ Quiet!™ Technology 5-41
 - 5.7.2 Launching the Cool ‘n’ Quiet!™ software 5-42
- 5.8 Using the NVIDIA® nTune™ utility 5-43
 - 5.8.1 Managing your nForce™ system 5-43
 - 5.8.2 Clock control 5-44
 - 5.8.3 Voltage/Fan control 5-44
 - 5.8.4 Information 5-45
 - 5.8.5 Other options 5-45
- 5.9 Using the ASUS AI Selector utility 5-46
 - 5.9.1 Launching the ASUS AI Selector 5-46
 - 5.9.2 Using the SLI mode 5-47

Chapter 6: SLI™ technology support

- 6.1 Overview 6-1
 - 6.1.1 Requirements 6-1
 - 6.1.2 ASUS Certified SLI Graphics cards 6-1

6.2	Dual graphics card setup	6-3
6.2.1	Installing SLI-ready graphics cards.....	6-3
6.2.2	Setting the SLI mode in BIOS.....	6-7
6.2.3	Installing the device drivers	6-7
6.2.4	Enabling the multi-GPU feature in Windows.....	6-7

Appendix

A.1	Using the SATA extension module	A-1
A.1.1	Installing the 2-port SATA extension module	A-1
A.1.1	Installing SATA hard drives	A-2

Notices

Federal Communications Commission Statement

This device complies with Part 15 of the FCC Rules. Operation is subject to the following two conditions:

- This device may not cause harmful interference, and
- This device must accept any interference received including interference that may cause undesired operation.

This equipment has been tested and found to comply with the limits for a Class B digital device, pursuant to Part 15 of the FCC Rules. These limits are designed to provide reasonable protection against harmful interference in a residential installation. This equipment generates, uses and can radiate radio frequency energy and, if not installed and used in accordance with manufacturer's instructions, may cause harmful interference to radio communications. However, there is no guarantee that interference will not occur in a particular installation. If this equipment does cause harmful interference to radio or television reception, which can be determined by turning the equipment off and on, the user is encouraged to try to correct the interference by one or more of the following measures:

- Reorient or relocate the receiving antenna.
- Increase the separation between the equipment and receiver.
- Connect the equipment to an outlet on a circuit different from that to which the receiver is connected.
- Consult the dealer or an experienced radio/TV technician for help.



The use of shielded cables for connection of the monitor to the graphics card is required to assure compliance with FCC regulations. Changes or modifications to this unit not expressly approved by the party responsible for compliance could void the user's authority to operate this equipment.

Canadian Department of Communications Statement

This digital apparatus does not exceed the Class B limits for radio noise emissions from digital apparatus set out in the Radio Interference Regulations of the Canadian Department of Communications.

This class B digital apparatus complies with Canadian ICES-003.

Safety information

Electrical safety

- To prevent electrical shock hazard, disconnect the power cable from the electrical outlet before relocating the system.
- When adding or removing devices to or from the system, ensure that the power cables for the devices are unplugged before the signal cables are connected. If possible, disconnect all power cables from the existing system before you add a device.
- Before connecting or removing signal cables from the motherboard, ensure that all power cables are unplugged.
- Seek professional assistance before using an adapter or extension cord. These devices could interrupt the grounding circuit.
- Make sure that your power supply is set to the correct voltage in your area. If you are not sure about the voltage of the electrical outlet you are using, contact your local power company.
- If the power supply is broken, do not try to fix it by yourself. Contact a qualified service technician or your retailer.

Operation safety

- Before installing the motherboard and adding devices on it, carefully read all the manuals that came with the package.
- Before using the product, make sure all cables are correctly connected and the power cables are not damaged. If you detect any damage, contact your dealer immediately.
- To avoid short circuits, keep paper clips, screws, and staples away from connectors, slots, sockets and circuitry.
- Avoid dust, humidity, and temperature extremes. Do not place the product in any area where it may become wet.
- Place the product on a stable surface.
- If you encounter technical problems with the product, contact a qualified service technician or your retailer.



The symbol of the crossed out wheeled bin indicates that the product (electrical and electronic equipment) should not be placed in municipal waste. Check local regulations for disposal of electronic products.

About this guide

This user guide contains the information you need when installing and configuring the motherboard.

How this guide is organized

This manual contains the following parts:

- **Chapter 1: Product introduction**
This chapter describes the features of the motherboard and the new technology it supports.
- **Chapter 2: Hardware information**
This chapter lists the hardware setup procedures that you have to perform when installing system components. It includes description of the switches, jumpers, and connectors on the motherboard.
- **Chapter 3: Powering up**
This chapter describes the power up sequence, the vocal POST messages, and ways of shutting down the system.
- **Chapter 4: BIOS setup**
This chapter tells how to change system settings through the BIOS Setup menus. Detailed descriptions of the BIOS parameters are also provided.
- **Chapter 5: Software support**
This chapter describes the contents of the support CD that comes with the motherboard package.
- **Chapter 6: NVIDIA® SLI™ technology support**
This chapter tells how to install SLI-ready PCI Express graphics cards.
- **Appendix: Installation options**
This appendix describes how to install optional accessories to your motherboard.

Where to find more information

Refer to the following sources for additional information and for product and software updates.

1. ASUS websites

The ASUS website provides updated information on ASUS hardware and software products. Refer to the ASUS contact information.

2. Optional documentation

Your product package may include optional documentation, such as warranty flyers, that may have been added by your dealer. These documents are not part of the standard package.

Conventions used in this guide

To make sure that you perform certain tasks properly, take note of the following symbols used throughout this manual.



DANGER/WARNING: Information to prevent injury to yourself when trying to complete a task.



CAUTION: Information to prevent damage to the components when trying to complete a task.



IMPORTANT: Instructions that you **MUST** follow to complete a task.



NOTE: Tips and additional information to help you complete a task.

Typography

Bold text

Indicates a menu or an item to select

Italics

Used to emphasize a word or a phrase

<Key>

Keys enclosed in the less-than and greater-than sign means that you must press the enclosed key

Example: <Enter> means that you must press the Enter or Return key

<Key1>+<Key2>+<Key3>

If you must press two or more keys simultaneously, the key names are linked with a plus sign (+)

Example: <Ctrl>+<Alt>+<D>

Command

Means that you must type the command exactly as shown, then supply the required item or value enclosed in brackets

Example: At the DOS prompt, type the command line:

awdf flash A8NSLI .ROM

A8N-SLI Premium specifications summary

CPU	<p>Socket 939 for AMD Athlon™ 64FX/AMD Athlon™ 64 processor</p> <p>Supports AMD 64 architecture that enables simultaneous 32-bit and 64-bit architecture</p> <p>Supports AMD® Cool 'n' Quiet! Technology</p>
Chipset	<p>NVIDIA® nForce™ 4 SLI</p> <p>Supports NVIDIA® Scalable Link Interface™ (SLI) technology</p>
System Bus	1600/2000 MT per second
Memory	<p>Dual-channel memory architecture</p> <p>4 x 184-pin DIMM sockets support ECC/non-ECC unbuffered 400/333/266 MHz DDR memory modules</p> <p>Supports up to 4 GB system memory</p>
Expansion slots	<p>2 x PCI Express x16 slots with Scalable Link Interface (SLI™) support</p> <p>1 x PCI Express x1 slot</p> <p>1 x PCI Express x4 slot running at 1 GB/s bandwidth</p> <p>3 x PCI slots</p>
Scalable Link Interface (SLI™)	<p>SLI™ mode supports:</p> <ul style="list-style-type: none"> - 2 x identical SLI™-ready PCI Express x16 graphics cards <p>(Note: In SLI mode, the PCI Express x16 slots work at the bandwidth of PCI Express x8. The combined bandwidth of these maintain the bandwidth of PCI Express x16.)</p> <p>Single card mode supports (default):</p> <ul style="list-style-type: none"> - 1 x any PCI Express x16 graphics card on the first slot (blue) <p>ASUS AI Selector</p> <p>ASUS EZ Plug™</p> <p>ASUS PEG Link for dual PCI Express graphics cards</p> <p>ASUS Two-slot thermal design</p>
Storage	<p>NVIDIA® nForce™ 4 SLI chipset supports:</p> <ul style="list-style-type: none"> - 2 x Ultra DMA 133/100/66/33 - 4 x Serial ATA II devices - RAID 0, RAID 1, RAID 0+1, and JBOD <p>Silicon Image 3114R RAID controller supports:</p> <ul style="list-style-type: none"> - 4 x Serial ATA with RAID 0, RAID 1, RAID 0+1, and RAID 5 configuration

(continued on the next page)

A8N-SLI Premium specifications summary

AI Overclocking	AI NOS™ (Non-Delay Overclocking System) ASUS AI Overclocking (Intelligent CPU frequency tuner) ASUS PEG Link for single/dual graphics card Fixed PCI Express/PCI/SATA frequencies ASUS C.P.R. (CPU Parameter Recall) Precision Tweaker supports: <ul style="list-style-type: none">- DIMM voltage: 9-step DRAM voltage control- Core voltage: Adjustable CPU voltage at 0.0125 increment- PCI Express Frequency: Allows 1MHz increment from 100MHz to 200MHz- Stepless Frequency Selection(SFS) allows 1MHz increment from 200 MHz to 400 MHz
Special features	ASUS AI Cool-Pipe ASUS AI Selector ASUS Post Reporter™ ASUS EZFlash ASUS Q-Fan ASUS CrashFree BIOS 2 ASUS Multi-language BIOS ASUS MyLogo2 ASUS Instant Music ASUS SLI Warning LED ASUS EZ Plug
Internal connectors	1 x Floppy disk drive connector 2 x IDE connectors 8 x Serial ATA connectors 1 x CPU fan connector 1 x Power fan connector 2 x Chassis fan connector 1 x Chipset fan connector 1 x Serial port connector (COM port) 1 x 24-pin ATX power connector 1 x 4-pin ATX 12 V power connector 1 x 4-pin ASUS EZ Plug™ connector 3 x USB 2.0 connectors for 6 additional USB 2.0 ports 1 x Internal audio connectors (CD\AUX) 1 x IEEE 1394 connector 1 x GAME/MIDI connector 1 x Chassis intrusion connector 1 x Front panel audio connector System panel connector

(continued on the next page)

A8N-SLI Premium specifications summary

LAN	<p>NVIDIA® nForce™ 4 built-in Gigabit MAC with external Marvell® PHY supports:</p> <ul style="list-style-type: none"> - NV ActiveArmor - NV Firewall - AI NET2 <p>Marvell® 88E8001 PCI Gigabit LAN controller supports:</p> <ul style="list-style-type: none"> - Marvell® Virtual Cable Tester technology - AI NET2
AI Audio	<p>Realtek® ALC850 8-channel CODEC</p> <ul style="list-style-type: none"> 1 x Coaxial S/PDIF out port 1 x Optical S/PDIF out port <p>Supports Universal Audio Jack (UAJ®) Technology</p> <p>Supports Audio Sensing and Enumeration Technology</p>
IEEE 1394	<p>T1 1394a controller supports:</p> <ul style="list-style-type: none"> - 2 x IEEE 1394 connector
USB	Supports up to 10 USB 2.0 ports
Rear panel	<ul style="list-style-type: none"> 1 x Parallel port 1 x IEEE 1394 port 2 x LAN (RJ-45) port 4 x USB 2.0 ports 1 x Optical S/PDIF out port 1 x Coaxial S/PDIF out port 1 x PS/2 keyboard port 1 x PS/2 mouse port 8-channel audio ports
BIOS features	4 Mb Flash ROM, Phoenix-Award BIOS, PnP, DMI2.0, WfM2.0, SM BIOS 2.3
Power Requirement	ATX power supply (with 24-pin and 4-pin 12 V plugs) ATX 12 V 2.0 compliant
Form Factor	ATX form factor: 12 in x 9.6 in (30.5 cm x 24.4 cm)
Support CD contents	<ul style="list-style-type: none"> Device drivers ASUS PC Probe ASUS Live Update utility ASUS Cool'n'Quiet! utility Anti-virus utility (OEM version) NVIDIA® nTune™ utility

*Specifications are subject to change without notice.

This chapter describes the motherboard features and the new technologies it supports.

1 Product introduction

Chapter summary

1.1	Welcome!	1-1
1.2	Package contents	1-1
1.3	Special features	1-2

1.1 Welcome!

Thank you for buying an ASUS® A8N-SLI Premium motherboard!

The motherboard delivers a host of new features and latest technologies, making it another standout in the long line of ASUS quality motherboards!

Before you start installing the motherboard, and hardware devices on it, check the items in your package with the list below.

1.2 Package contents

Check your motherboard package for the following items.

Motherboard	ASUS A8N-SLI Premium motherboard
I/O modules	Serial ATA 2-port extension module IEEE1394 (1 port) module USB 2.0 2-port module USB 2.0 + GAME port module
Cables	8 x Serial ATA signal cables Serial ATA power cable with dual plugs Ultra DMA/133 cable 40-conductor IDE cable Floppy disk drive cable COM cable
Accessories	I/O shield SLI™ flexible cable
Application CDs	ASUS motherboard support CD InterVideo® WinDVD Suite® (retail box only)
Documentation	User guide



If any of the above items is damaged or missing, contact your retailer.

1.3 Special features

1.3.1 Product highlights



Latest processor technology

The AMD Athlon™ 64FX and Athlon™ 64 desktop processors are based on AMD's 64-bit and 32-bit architecture, which represents the landmark introduction of the industry's first x86-64 technology. These processors provide a dramatic leap forward in compatibility, performance, investment protection, and reduced total cost of ownership and development. See page 2-6.



Scalable Link Interface (SLI™) technology

The NVIDIA® nForce4® Scalable Link Interface (SLI™) technology allows two graphics processing units (GPUs) in a single system. This technology takes advantage of the PCI Express™ bus architecture and features intelligent hardware and software solutions that allows multiple GPUs to work together and achieve exceptional graphics performance. See Chapter 6 for details.

Built-in NVFirewall™ and NVActiveArmor™



The NVIDIA® Firewall™ (NVFirewall™) is an easy-to-use high-performance desktop firewall application that protects your system from intruders. Integrated into the NVIDIA® nForce4® SLI™ chipset with the NVIDIA® Gigabit Ethernet, it provides advanced anti-computer-hacking technologies, remote management capabilities, and a user-friendly setup wizard that improves overall system security.

Enhancing your network security is the NVIDIA® ActiveArmor™ (NV ActiveArmor™) engine that provides advanced data packet inspection. This innovative technology ensures that only safe data packets are passed on the network. It boosts overall system performance by offloading the CPU from the rigorous task of filtering data packets. See page 5-18 for details.

AMD Cool 'n' Quiet!™ Technology

The motherboard supports the AMD Cool 'n' Quiet!™ Technology that dynamically and automatically changes the CPU speed, voltage and amount of power depending on the task the CPU performs. See pages 4-20 and 5-41.

HyperTransport™ Technology

HyperTransport™ Technology is a high-speed, low latency, point-to-point link designed to increase the communication speed between integrated circuits in computers, networking and telecommunications equipment up to 48 times faster than other existing technologies.

Dual Channel DDR memory support

Employing the Double Data Rate (DDR) memory technology, the motherboard supports up to 4GB of system memory using DDR400/333/266 DIMMs. The ultra-fast 400MHz memory bus delivers the required bandwidth for the latest 3D graphics, multimedia, and Internet applications. See page 2-11.

Serial ATA II technology

The motherboard supports the next-generation Serial ATA 3Gb/s technology through the Serial ATA interfaces and the NVIDIA® SLI™ chipset. The SATA 3Gb/s specification provides twice the bandwidth of the current Serial ATA products with a host of new features including Native Command Queuing (NCQ), Power Management (PM) Implementation Algorithm, and Hot Swap. Additionally, Serial ATA allows thinner, more flexible cables with lower pin count, and reduced voltage requirement. See pages 2-22 and 2-23.

Dual RAID solution

Onboard RAID controllers provide the motherboard with dual-RAID functionality that allows you to select the best RAID solution using IDE or Serial ATA devices.

The NVIDIA® nForce4® SLI™ allows RAID 0, RAID 1, RAID 0+1 and JBOD configuration for four SATA connectors or two PATA connectors. See pages 2-22 and 5-23 for details.

The SiI3114R controller supports four additional SATA connectors and allows RAID 0, RAID 1, RAID 0+1, and a software patch to support a bootable RAID 5 configuration. See pages 2-23 and 5-30 for details.

PCI Express™ interface

The motherboard fully supports PCI Express, the latest I/O interconnect technology that speeds up the PCI bus. PCI Express features point-to-point serial interconnections between devices and allows higher clockspeeds by carrying data in packets. This high speed interface is software compatible with existing PCI specifications. See page 2-17 for details.

S/PDIF digital sound ready

The motherboard supports the S/PDIF Out function through the S/PDIF interfaces on the rear panel. The S/PDIF technology turns your computer into a high-end entertainment system with digital connectivity to powerful audio and speaker systems. See page 2-19 for details.

IEEE 1394a support

The IEEE 1394a interface provides high-speed and flexible PC connectivity to a wide range of peripherals and devices compliant to the IEEE 1394a standard. The IEEE 1394a interface allows up to 400 Mbps transfer rates through simple, low-cost, high-bandwidth asynchronous (real-time) data interfacing between computers, peripherals, and consumer electronic devices such as camcorders, VCRs, printers, TVs, and digital cameras. See pages 2-19 and 2-28 for details.

USB 2.0 technology

The motherboard implements the Universal Serial Bus (USB) 2.0 specification, dramatically increasing the connection speed from the 12 Mbps bandwidth on USB 1.1 to a fast 480 Mbps on USB 2.0. USB 2.0 is backward compatible with USB 1.1. See page 2-19 and 2-25 for details.

Temperature, fan, and voltage monitoring

The CPU temperature is monitored by the ASIC (integrated in the Winbond Super I/O) to prevent overheating and damage. The system fan rotations per minute (RPM) is monitored for timely failure detection. The ASIC monitors the voltage levels to ensure stable supply of current for critical components. See section “4.5.4 Hardware Monitor” on page 4-38.

1.3.2 ASUS Proactive features

AI NOS™ (Non-Delay Overclocking System)

ASUS Non-delay Overclocking System™ (NOS) is a technology that auto-detects the CPU loading and dynamically overclocks the CPU speed only when needed. See page 4-30 for details.

AI Cool-Pipe

ASUS AI Cool-Pipe is a unique heat pipe design that dissipates heat away from the chipset. This device significantly lowers overall system temperature for a quiet and stable system performance.

Precision Tweaker

Designed for overclocking aficionados, this feature allows you to fine tune the CPU/memory voltage and gradually increase the Front Side Bus (FSB) and PCI Express frequency to achieve maximum system performance.

AI NET 2

AI NET 2 is a BIOS-based diagnostic tool that detects and reports Ethernet cable faults and shorts. With this utility, you can easily monitor the condition of the Ethernet cable(s) connected to the LAN (RJ-45) port(s). During the bootup process, AI NET 2 immediately diagnoses the LAN cable(s) and reports shorts and faults up to 100 meters at 1 meter accuracy. See pages 4-32 and 5-11 for details.

AI Audio technology

The motherboard supports 8-channel audio through the onboard ALC850 CODEC with 16-bit DAC, a stereo 16-bit ADC, and an AC97 2.3 compatible multi-channel audio designed for PC multimedia systems. It also provides Jack-Sensing function, S/PDIF out support, interrupt capability and includes the Realtek® proprietary UAJ® (Universal Audio Jack) technology. See pages 2-19, 2-20 and 5-12 for details.

1.3.3 Innovative ASUS features

ASUS AI Selector

The AI Selector allows you to set the video card mode of your system. This utility works when you have two graphics cards installed in your system. See page 5-46 for details.

ASUS EZ Plug™



This patented ASUS technology is a 4-pin auxiliary +12V connector that is designed to maintain the voltage integrity of your system. This plug guarantees adequate supply of power to the motherboard and other installed peripherals. See page 6-5 for illustration.

ASUS Two-slot thermal design

The motherboard is designed with two PCI Express x1 slots placed between the PCI Express x16 slots allowing an increase in airflow between the two PCI Express x16 graphics cards. This special design permits more room for ventilation thus lowering the overall system temperature.

CrashFree BIOS 2

This feature allows you to restore the original BIOS data from the support CD in case when the BIOS codes and data are corrupted. This protection eliminates the need to buy a replacement ROM chip. See details on page 4-5.

ASUS Q-Fan technology

The ASUS Q-Fan technology smartly adjusts the fan speeds according to the system loading to ensure quiet, cool, and efficient operation. See page 4-38 for details.

ASUS POST Reporter™

The motherboard offers a new exciting feature called the ASUS POST Reporter™ to provide friendly voice messages and alerts during the Power-On Self-Tests (POST) informing you of the system boot status and causes of boot errors, if any. The bundled Winbond Voice Editor software lets you to customize the voice messages in different languages. See page 3-4 for details.

ASUS Multi-language BIOS



The multi-language BIOS allows you to select the language of your choice from the available options. The localized BIOS menus allow you to configure easier and faster. See page 4-15 for details.

ASUS MyLogo2™



This new feature present in the motherboard allows you to personalize and add style to your system with customizable boot logos. See page 5-9 for details.

ASUS Instant Music



This unique feature allows you to playback audio files even without booting the system to Windows™. Just press the ASUS Instant Music special function keys and enjoy the music! See pages 4-34.

This chapter lists the hardware setup procedures that you have to perform when installing system components. It includes description of the jumpers and connectors on the motherboard.

Hardware 2 information

Chapter summary

2.1	Before you proceed	2-1
2.2	Motherboard overview	2-2
2.3	Central Processing Unit (CPU)	2-6
2.4	System memory.....	2-11
2.5	Expansion slots	2-15
2.6	Jumpers	2-18
2.7	Connectors	2-19

2.1 Before you proceed

Take note of the following precautions before you install motherboard components or change any motherboard settings.



- Make sure that your power supply unit (PSU) can provide at least the minimum power required by your system. See “8. ATX power connectors” on page 2-26 for details.
- Unplug the power cord from the wall socket before touching any component.
- Use a grounded wrist strap or touch a safely grounded object or to a metal object, such as the power supply case, before handling components to avoid damaging them due to static electricity
- Hold components by the edges to avoid touching the ICs on them.
- Whenever you uninstall any component, place it on a grounded antistatic pad or in the bag that came with the component.
- Before you install or remove any component, ensure that the ATX power supply is switched off or the power cord is detached from the power supply. Failure to do so may cause severe damage to the motherboard, peripherals, and/or components.

Onboard LED

The motherboard comes with a standby power LED that lights up to indicate that the system is ON, in sleep mode, or in soft-off mode. This is a reminder that you should shut down the system and unplug the power cable before removing or plugging in any motherboard component. The illustration below shows the location of the onboard LED.

The red warning LED lights up when you installed two graphics card but did not connect the ASUS EZ Plug™. The illustration below shows the location of the onboard LEDs.

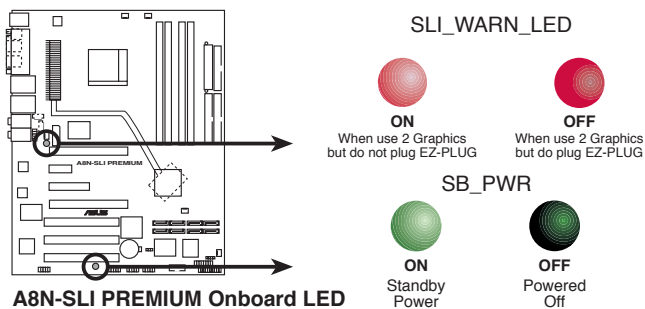

2.2 Motherboard overview

Before you install the motherboard, study the configuration of your chassis to ensure that the motherboard fits into it.



Make sure to unplug the power cord before installing or removing the motherboard. Failure to do so can cause you physical injury and damage motherboard components.

2.2.1 Placement direction

When installing the motherboard, make sure that you place it into the chassis in the correct orientation. The edge with external ports goes to the rear part of the chassis as indicated in the image below.

2.2.2 Screw holes

Place nine (9) screws into the holes indicated by circles to secure the motherboard to the chassis.



Do not overtighten the screws! Doing so can damage the motherboard.

Place this side towards
the rear of the chassis

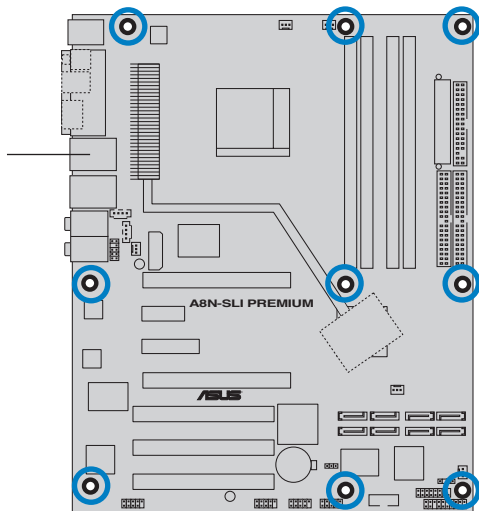

2.2.3 Motherboard layout

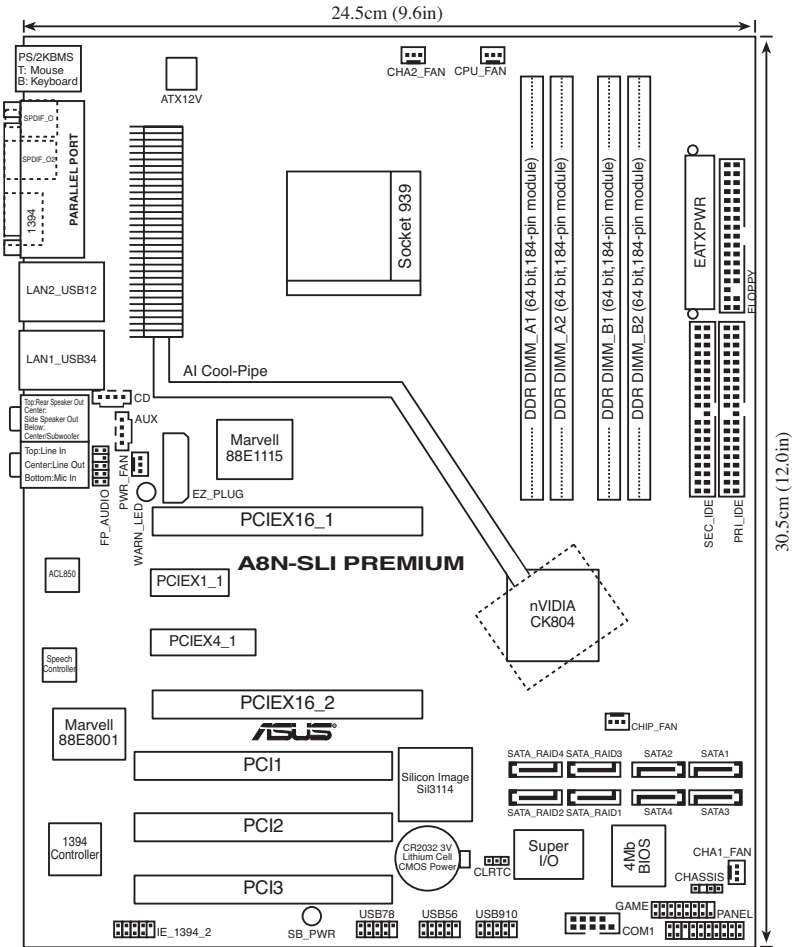

2.2.4 Layout Contents

Slots	Page
1. DDR DIMM slots	2-11
2. PCI slots	2-17
3. PCI Express x16 slot	2-17
4. PCI Express x1 slot	2-17
5. PCI Express x4 slot	2-17

Jumpers	Page
1. Clear RTC RAM (3-pin CLRTC1)	2-18

Rear panel connectors	Page
1. PS/2 mouse port (green)	2-19
2. Parallel port	2-19
3. LAN 2 (RJ-45) port	2-19
4. LAN 1 (RJ-45) port	2-19
5. Rear Speaker Out port (gray)	2-19
6. Side Speaker Out port (black)	2-19
7. Line In port (light blue)	2-19
8. Line Out port (lime)	2-19
9. Microphone port (pink)	2-20
10. Center/Subwoofer port (yellow orange)	2-20
11. USB 2.0 ports 3 and 4	2-20
12. USB 2.0 ports 1 and 2	2-20
13. IEEE 1394a port	2-20
14. Optical S/PDIF out port	2-20
15. Coaxial S/PDIF out port	2-20
16. PS/2 keyboard port (purple)	2-20

Internal connectors	Page
1. Floppy disk drive connector (34-1 pin FLOPPY)	2-21
2. Primary IDE connector (40-1 pin PRI_IDE)	2-21
3. Secondary IDE connector (40-1 pin SEC_IDE)	2-21
4. nForce 4 Serial ATA connectors (7-pin SATA1, SATA2, SATA3, SATA4)	2-22
5. Silicon Image Serial ATA RAID connectors (7-pin SATA_RAID1, SATA_RAID2, SATA_RAID3, SATA_RAID4)	2-23
6. CPU fan connector (3-pin CPU_FAN)	2-24
7. Power fan connector (3-pin PWR_FAN)	2-24
8. Chassis fan 1 connector (3-pin CHA1_FAN)	2-24
9. Chassis fan 2 connector (3-pin CHA2_FAN)	2-24
10. Chipset fan connector (3-pin CHIP_FAN)	2-24
11. Serial port connector (10-1 pin COM1)	2-25
12. USB headers (10-1 USB56, USB78, USB910)	2-25
13. ATX power connector (24-pin EATXPWR1)	2-26
14. ATX 12V power connector (4-pin ATX12V1)	2-26
15. ATX 12V power connector (4-pin EZ_PLUG)	2-26
16. Optical audio connector (4-pin CD)	2-27
17. Auxiliary audio connector (4-pin AUX)	2-27
18. GAME/MIDI connector (16-1 pin GAME)	2-27
19. Chassis intrusion connector (4-1 pin CHASSIS)	2-28
20. IEEE 1394a connector (10-1 pin IE1394_2)	2-28
21. Front panel audio connector (10-1 pin FP_AUDIO)	2-29
22. System panel connectors (20-1 pin PANEL)	2-29
- System Power LED (Green 3-pin PLED)	
- Hard Disk activity (Red 2-pin IDE_LED)	
- System warning speaker (Orange 4-pin SPEAKER)	
- Power/Soft-off button (Yellow 2-pin PWRSW)	
- Reset switch (Blue 2-pin RESET)	

2.3 Central Processing Unit (CPU)

2.3.1 Overview

The motherboard comes with a surface mount 939-pin Zero Insertion Force (ZIF) socket designed for the AMD Athlon™ 64FX or AMD Athlon 64™ processor.

The 128-bit-wide data paths of these processors can run applications faster than processors with only 32-bit or 64-bit wide data paths.

Take note of the marked corner (with gold triangle) on the CPU. This mark should match a specific corner on the socket to ensure correct installation.

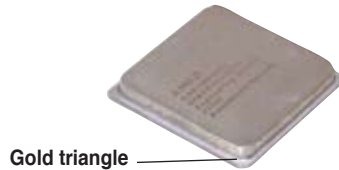

2.3.2 Installing the CPU

To install a CPU:

1. Locate the CPU socket on the motherboard.

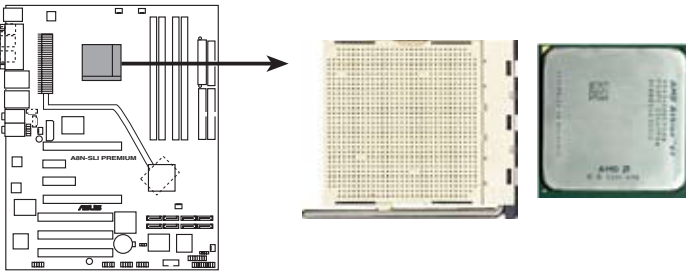

A8N-SLI PREMIUM CPU Socket 939



Before installing the CPU, make sure that the socket box is facing towards you and the load lever is on your left.

2. Unlock the socket by pressing the lever sideways, then lift it up to a 90°-100° angle.

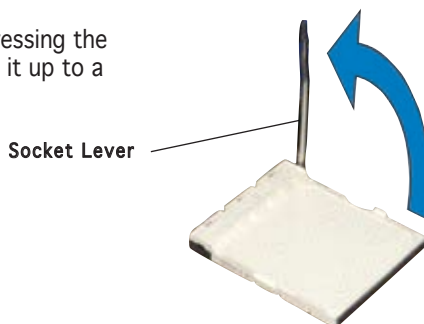

Make sure that the socket lever is lifted up to 90°-100° angle, otherwise the CPU does not fit in completely.

3. Position the CPU above the socket such that the CPU corner with the gold triangle matches the socket corner with a small triangle.
4. Carefully insert the CPU into the socket until it fits in place.

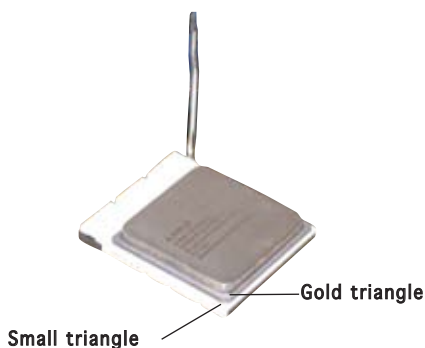

The CPU fits only in one correct orientation. DO NOT force the CPU into the socket to prevent bending the pins and damaging the CPU!

5. When the CPU is in place, push down the socket lever to secure the CPU. The lever clicks on the side tab to indicate that it is locked.



2.3.3 Installing the heatsink and fan

The AMD Athlon™ 64FX or AMD Athlon 64™ processor require a specially designed heatsink and fan assembly to ensure optimum thermal condition and performance.



Make sure that you use only qualified heatsink and fan assembly.

Follow these steps to install the CPU heatsink and fan.

1. Place the heatsink on top of the installed CPU, making sure that the heatsink fits properly on the retention module base.



-
- The retention module base is already installed on the motherboard upon purchase.
 - You do not have to remove the retention module base when installing the CPU or installing other motherboard components.
 - If you purchased a separate CPU heatsink and fan assembly, make sure that a Thermal Interface Material is properly applied to the CPU heatsink or CPU before you install the heatsink and fan assembly.
-

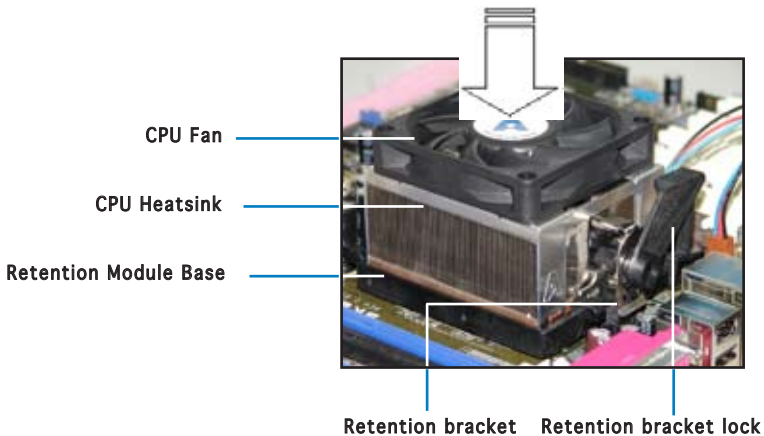

Your boxed CPU heatsink and fan assembly should come with installation instructions for the CPU, heatsink, and the retention mechanism. If the instructions in this section do not match the CPU documentation, follow the latter.

2. Attach one end of the retention bracket to the retention module base.

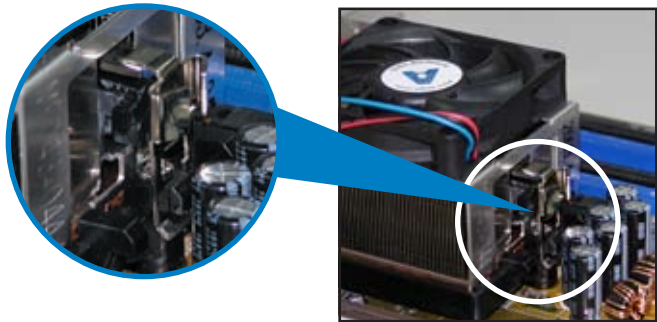

3. Align the other end of the retention bracket (near the retention bracket lock) to the retention module base. A clicking sound denotes that the retention bracket is in place.



Make sure that the fan and heatsink assembly perfectly fits the retention mechanism module base, otherwise you cannot snap the retention bracket in place.



4. Push down the retention bracket lock on the retention mechanism to secure the heatsink and fan to the module base.

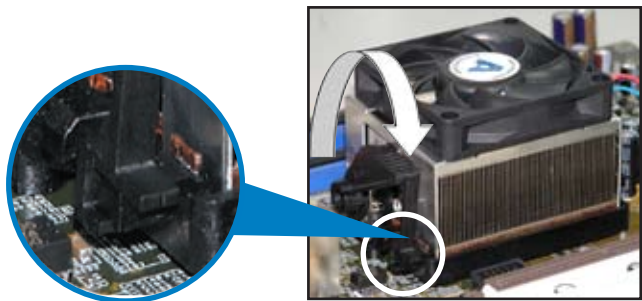

- When the fan and heatsink assembly is in place, connect the CPU fan cable to the connector on the motherboard labeled CPU_FAN.

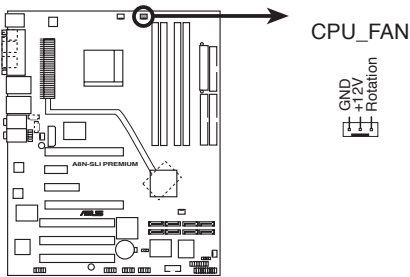

A8N-SLI PREMIUM CPU fan connector



Do not forget to connect the CPU fan connector! Hardware monitoring errors can occur if you fail to plug this connector.

2.4 System memory

2.4.1 Overview

The motherboard comes with four 184-pin Double Data Rate (DDR) Dual In-line Memory Modules (DIMM) sockets.

The following figure illustrates the location of the sockets:

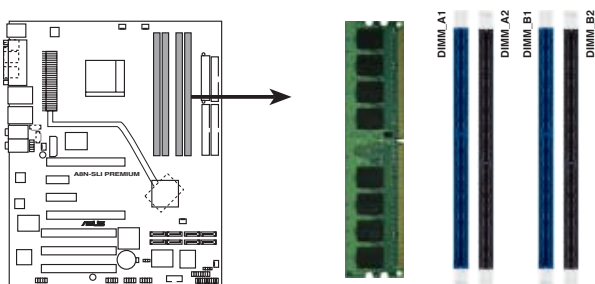

A8N-SLI PREMIUM 184-pin DDR DIMM sockets

Channel	Sockets
Channel A	DIMM_A1 and DIMM_A2
Channel B	DIMM_B1 and DIMM_B2

2.4.2 Memory Configurations

You may install 256 MB, 512 MB and 1 GB unbuffered ECC or non-ECC DDR DIMMs into the DIMM sockets using the memory configurations in this section.



- For dual-channel configuration, the total size of memory module(s) installed per channel must be the same for better performance (DIMM_A1+DIMM_A2=DIMM_B1+DIMM_B2).
- When using one DDR DIMM module, install into DIMM_B1 slot only.
- When using two DDR DIMM modules, install into DIMM_A1 and DIMM_B1 slots only.
- Always install DIMMs with the same CAS latency. For optimum compatibility, it is recommended that you obtain memory modules from the same vendor. Refer to the DDR400 Qualified Vendors List on the next page for details.
- Due to chipset resource allocation, the system may detect less than 4 GB of system memory when you installed four 1 GB DDR memory modules.
- Due to CPU limitation, DIMM modules with 128 Mb memory chips or double-sided x16 memory chips are not supported in this motherboard.

Table 2 DDR400 Qualified Vendors List

Size	Vendor	Model	Brand	Side(s)	Component	DIMM support		
						A	B	C
256MB	KINGSTON	KVR400X64C3A/256	Hynix	SS	HY5DU56822BT-D43	•	•	•
512MB	KINGSTON	KVR400X64C3A/512	Hynix	DS	HY5DU56822BT-D43	•	•	•
256MB	KINGSTON	KVR400X72C3A/256	Mosel	SS	V58C2256804SATS(ECC)	•	•	•
512MB	KINGSTON	KVR400X72C3A/512	Mosel	DS	V58C2256804SATS(ECC)	•	•	•
256MB	KINGSTON	KVR400X64C3A/256	Infineon	SS	HYB25D256800BT-5B	•	•	•
512MB	KINGSTON	KVR400X64C3A/512	Infineon	DS	HYB25D256809BT-5B	•	•	•
256MB	KINGSTON	KVR400X64C3A/256	KINGSTON	SS	D3208DLT2-5	•	•	•
512MB	KINGSTON	KVR400X64C3A/512	KINGSTON	DS	D328DIB-50	•	•	•
512MB	KINGSTON	KHX3200A/512	N/A	DS	N/A	•	•	•
1024MB	KINGSTON	KVR400X64C3A/1G	N/A	DS	HYB25D512800BE-5B	•	•	•
256MB	SAMSUNG	M381L3223ETM-CCC	SAMSUNG	SS	K4H560838E-TCCC(ECC)	•	•	•
512MB	SAMSUNG	M381L6423ETM-CCC	SAMSUNG	DS	K4H560838E-TCCC(ECC)	•	•	•
256MB	SAMSUNG	M368L3223ETM-CCC	SAMSUNG	SS	K4H560838E-TCCC	•	•	•
256MB	SAMSUNG	M368L3223FTN-CCC	SAMSUNG	SS	K4H560838F-TCCC	•	•	•
512MB	SAMSUNG	M368L6423FTN-CCC	SAMSUNG	DS	K4H560838F-TCCC	•	•	•
512MB	SAMSUNG	M368L6523BTM-CCC	SAMSUNG	SS	K4H510838B-TCCC	•	•	•
256MB	MICRON	MT8VDDT3264AG-40BCB	MICRON	SS	MT46V32M8TG-5BC	•	•	•
512MB	MICRON	MT16VDDT6464AG-40BCB	MICRON	DS	MT46V32M8TG-5BC	•	•	•
256MB	Infineon	HY564D32300HU-5-C	Infineon	SS	HYB25D256800CE-5C	•	•	•
512MB	Infineon	HY564D64320HU-5-C	Infineon	DS	HYB25D256800CE-5C	•	•	•
256MB	CORSAIR	CMX256A-3200C2PT	Winbond	SS	W942508BH-5	•	•	•
512MB	CORSAIR	V5512MB400	VALUE seLect	DS	V532M8-5	•	•	•
512MB	CORSAIR	CMX512-3200C2	N/A	DS	N/A	•	•	•
1024MB	CORSAIR	TWIXX2048-3200C2	N/A	DS	N/A	•	•	•
256MB	Hynix	HYMD232645D8J-D43	Hynix	SS	HY5DU56822DT-D43	•	•	•
512MB	Hynix	HYMD264646D8J-D43	Hynix	DS	HY5DU56822DT-D43	•	•	•
256MB	GELIL	GE2563200B	GELIL	SS	GL3LC32G88TG-5A	•	•	•
512MB	GELIL	GE5123200B	GELIL	DS	GL3LC32G88TG-5A	•	•	•
256MB	GELIL	GD3200-256V	GELIL	SS	GLIL DDR 32M8	•	•	•
512MB	GELIL	GD3200-512V	GELIL	DS	GLIL DDR 32M8	•	•	•
256MB	TwinMOS	M2G9I08AIATT9F081AADT	TwinMOS	SS	TMD7608F8E50D	•	•	•
12MB	TwinMOS	M2G9J16AJATT9F081AADT	TwinMOS	DS	TMD7608F8E50D	•	•	•
256MB	TwinMOS	M2G9I08A8ATT9F081AADT	TwinMOS	SS	TMD7608F8E50D	•	•	•
512MB	TwinMOS	M2G9J16A8ATT9F081AADT	TwinMOS	DS	TMD7608F8E50D	•	•	•
256MB	Transcend	TS32MLD64V4F3	SAMSUNG	SS	K4H560838F-TCCC	•	•	•
512MB	Transcend	TS64MLD64V4F3	SAMSUNG	DS	K4H560838F-TCCC	•	•	•
1024MB	Transcend	TS128MLD64V4J	SAMSUNG	DS	K4H510838B-TCCC	•	•	•
256MB	Apacer	77.10636.33G	Infineon	SS	HYB25D256800CE-5C	•	•	•
512MB	Apacer	77.10736.33G	Infineon	DS	HYB25D256800CE-5C	•	•	•
256MB	Apacer	77.10639.60G	ProMOS	SS	V58C2256804SCT5B	•	•	•
512MB	Apacer	77.10739.60G	ProMOS	DS	V58C2256804SCT5B	•	•	•
256MB	A DATA	MDOSS6F3G31Y0K1E0Z	SAMSUNG	SS	K4H560838E-TCCC	•	•	•
512MB	A DATA	MDOSS6F3H41Y0N1E0Z	SAMSUNG	DS	K4H560838F-TCCC	•	•	•
256MB	A DATA	MDOHY6F3G31Y0N1E0Z	Hynix	SS	HY5DU56822CT-D43	•	•	•
512MB	A DATA	MDOHY6F3H41Y0N1E0Z	Hynix	DS	HY5DU56822CT-D43	•	•	•
256MB	A DATA	MDOADS5F3G31Y0D1E0Z	N/A	SS	ADD8608A8A-5B	•	•	•
512MB	A DATA	MDOADS5F3H41Y0D1E0Z	N/A	DS	ADD8608A8A-5B	•	•	•

(Continued on the next page)

DDR400 Qualified Vendors List

Size	Vendor	Model	Brand	Side(s)	Component	DIMM support		
						A	B	C
256MB	Winbond	W9425GCDB-5	Winbond	SS	W942508CH-5	•	•	•
512MB	Winbond	W9451GCDB-5	Winbond	DS	W942508CH-5	•	•	•
256MB	PSC	AL5D8B53T-5B1K	PSC	SS	A2S56D30BTP	•	•	•
512MB	PSC	AL6D8B53T-5B1K	PSC	DS	A2S56D30BTP	•	•	•
256MB	KINGMAX	MPXB62D-38KT3R	N/A	SS	KDL388P4LA-50	•	•	•
512MB	KINGMAX	MPXC22D-38KT3R	N/A	DS	KDL388P4LA-50	•	•	•
256MB	NANYA	NT256D64588C0G-5T	N/A	SS	NT5DS32M8CT-5T	•	•	•
512MB	NANYA	NT512D64588C0G-5T	N/A	DS	NT5DS32M8CT-5T	•	•	•
256MB	BRAIN POWER	B6U808-256M-SAM-400	SAMSUNG	SS	K4H560838D-TCC4	•	•	•
512MB	BRAIN POWER	B6U808-512M-SAM-400	SAMSUNG	DS	K4H560838D-TCC4	•	•	•
256MB	CENTURY	DXV658E15B3T27C	SAMSUNG	SS	K4H560838E-TCCC	•	•	•
512MB	CENTURY	DXV258E15B3T27C	SAMSUNG	DS	K4H560838E-TCCC	•	•	•
256MB	CENTURY	DXV658E15B3T27C	N/A	SS	DD2508AMTA	•	•	•
512MB	CENTURY	DXV258E15B3T27C	N/A	DS	DD2508AMTA	•	•	•
256MB	elixir	M2U25664D588C3G-5T	N/A	SS	N2DS25680CT-5T	•	•	•
512MB	elixir	M2U51264D588C1G-5T	N/A	DS	N2DS25680CT-5T	•	•	•
256MB	Kreton	N/A	VT	SS	VT3225804T-5	•	•	•
512MB	Kreton	N/A	VT	DS	VT3225804T-5	•	•	•
256MB	Veritech	VT400FMV/1561103	VT	SS	VT56DD32M8PC-5	•	•	•
512MB	Veritech	VT400FMV/5121003	VT	DS	VT56DD32M8PC-5	•	•	•
256MB	Pmi	MD44256VIT3208GMHA01	MOSEL	SS	V58C2256804SAT5B	•	•	•
512MB	Pmi	MD44512VIT3208GATA03	MOSEL	DS	V58C2256804SAT5B	•	•	•
256MB	ProMOS	V826632K245CTG-D0	N/A	SS	V58C2256804SCT5B	•	•	•
512MB	ProMOS	V826664K245CTG-D0	N/A	DS	V58C2256804SCT5B	•	•	•
256MB	Deutron	AL5D8C53T-5B1T	PSC	SS	A2S56D30CTP	•	•	•
512MB	Deutron	AL6D8C53T-5B1T	PSC	DS	A2S56D30CTP	•	•	•
512MB	crucial	BL6464Z402.16TG	Ballistix	DS	N/A	•	•	•
256MB	Novax	96M425653CE-40TB6	CEON	SS	C2S56D30TP-5	•	•	•
512MB	Novax	96M451253CE-40TB6	CEON	DS	C2S56D30TP-5	•	•	•
1024MB	KINGSTON	KVR400X64C3A/1G	N/A	DS	HYB25D512800BE-5B	•	•	•
1024MB	CORSAIR	TWINX2048-3200C2	N/A	DS	N/A	•	•	•
1024MB	Transcend	TS128MLD64V4J	SAMSUNG	DS	K4H510838B-TCCC	•	•	•

Side(s): SS - Single-Sided

DS - Double-Sided

DIMM Support:

- A - supports one module inserted into either the blue slots, in a Single-channel memory configuration.
- B - supports on pair of modules inserted into either the blue slots or the black slots as one pair of Dual-channel memory configuration.
- C - support for 4 modules inserted into the blue and black slots as two pairs of Dual-channel memory configuration.



Visit the ASUS website (www.asus.com) for the latest DDR 400 Qualified Vendors List.

2.4.3 Installing a DIMM



Make sure to unplug the power supply before adding or removing DIMMs or other system components. Failure to do so may cause severe damage to both the motherboard and the components.

1. Unlock a DIMM socket by pressing the retaining clips outward.
2. Align a DIMM on the socket such that the notch on the DIMM matches the break on the socket.

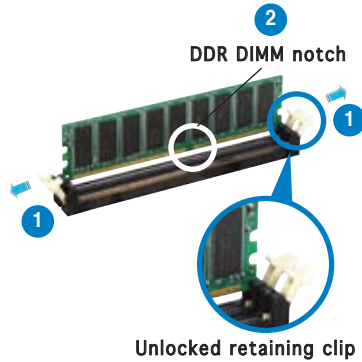

A DDR DIMM is keyed with a notch so that it fits in only one direction. DO NOT force a DIMM into a socket to avoid damaging the DIMM.

3. Firmly insert the DIMM into the socket until the retaining clips snap back in place and the DIMM is properly seated.

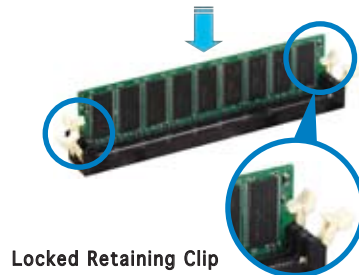

2.4.4 Removing a DIMM

Follow these steps to remove a DIMM.

1. Simultaneously press the retaining clips outward to unlock the DIMM.

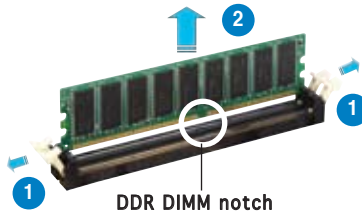

Support the DIMM lightly with your fingers when pressing the retaining clips. The DIMM might get damaged when it flips out with extra force.

2. Remove the DIMM from the socket.

2.5 Expansion slots

In the future, you may need to install expansion cards. The following sub-sections describe the slots and the expansion cards that they support.



Make sure to unplug the power cord before adding or removing expansion cards. Failure to do so may cause you physical injury and damage motherboard components.

2.5.1 Installing an expansion card

To install an expansion card:

1. Before installing the expansion card, read the documentation that came with it and make the necessary hardware settings for the card.
2. Remove the system unit cover (if your motherboard is already installed in a chassis).
3. Remove the bracket opposite the slot that you intend to use. Keep the screw for later use.
4. Align the card connector with the slot and press firmly until the card is completely seated on the slot.
5. Secure the card to the chassis with the screw you removed earlier.
6. Replace the system cover.

2.5.2 Configuring an expansion card

After installing the expansion card, configure the it by adjusting the software settings.

1. Turn on the system and change the necessary BIOS settings, if any. See Chapter 4 for information on BIOS setup.
2. Assign an IRQ to the card. Refer to the tables on the next page.
3. Install the software drivers for the expansion card.

2.5.3 Interrupt assignments

Standard interrupt assignments

IRQ	Priority	Standard Function
0	1	System Timer
1	2	Keyboard Controller
2	-	Re-direct to IRQ#9
4	12	Communications Port (COM1)*
5	13	IRQ holder for PCI steering*
6	14	Floppy Disk Controller
7	15	Printer Port (LPT1)*
8	3	System CMOS/Real Time Clock
9	4	IRQ holder for PCI steering*
10	5	IRQ holder for PCI steering*
11	6	IRQ holder for PCI steering*
12	7	PS/2 Compatible Mouse Port*
13	8	Numeric Data Processor
14	9	Primary IDE Channel
15	10	Secondary IDE Channel

* These IRQs are usually available for ISA or PCI devices.

IRQ assignments for this motherboard

	A	B	C	D	E	F	G	H
PCI slot 1	shared	—	—	—	—	—	—	—
PCI slot 2	—	shared	—	—	—	—	—	—
PCI slot 3	—	—	shared	—	—	—	—	—
Onboard USB 1.0 controller	shared	—	—	—	—	—	—	—
Onboard USB 2.0 controller	shared	—	—	—	—	—	—	—
Onboard LAN1	shared	—	—	—	—	—	—	—
Onboard LAN2	—	shared	—	—	—	—	—	—
Onboard PCI SATA RAID (SI)	—	—	—	shared	—	—	—	—
Onboard 1394a	shared	—	—	—	—	—	—	—



When using PCI cards on shared slots, ensure that the drivers support “Share IRQ” or that the cards do not need IRQ assignments. Otherwise, conflicts will arise between the two PCI groups, making the system unstable and the card inoperable.

2.5.4 PCI slots

The PCI slots support cards such as a LAN card, SCSI card, USB card, and other cards that comply with PCI specifications. The figure shows a LAN card installed on a PCI slot.



2.5.5 Two PCI Express x16 slots

This motherboard supports one PCI Express x16 graphics card or two SLI-ready PCI Express x16 graphic cards that comply with the PCI Express specifications. The figure shows a graphics card installed on the PCI Express x16 slot.

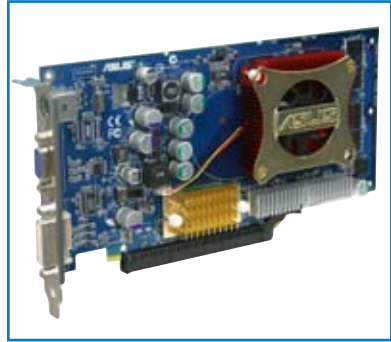

In Single Video Card mode, only the PCI Express blue slot can be used for PCI Express x16 graphics cards.

2.5.6 PCI Express x1 slot

This motherboard supports PCI Express x1 network cards, SCSI cards and other cards that comply with the PCI Express specifications. The figure shows a network card installed on the PCI Express x1 slot.

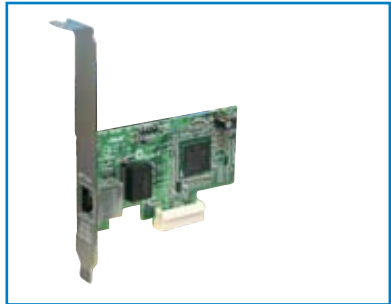

2.5.7 PCI Express x4 slot

This motherboard provides a PCI Express x4 slot that can support PCI Express x1, x4, x8, or x16 cards. This ASUS proprietary slot allows you to use additional PCI Express cards (e.g. graphics card) for twice the speed of a PCI Express x1 slot.

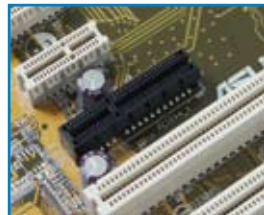

The Universal PCIe slot supports a total bandwidth of 1GB/s.

2.6 Jumpers

1. Clear RTC RAM (CLRTC)

This jumper allows you to clear the Real Time Clock (RTC) RAM in CMOS. You can clear the CMOS memory of date, time, and system setup parameters by erasing the CMOS RTC RAM data. The onboard button cell battery powers the RAM data in CMOS, which include system setup information such as system passwords.

To erase the RTC RAM:

1. Turn OFF the computer and unplug the power cord.
2. Remove the onboard battery.
3. Move the jumper cap from pins 1-2 (default) to pins 2-3. Keep the cap on pins 2-3 for about 5~10 seconds, then move the cap back to pins 1-2.
4. Re-install the battery.
5. Plug the power cord and turn ON the computer.
6. Hold down the key during the boot process and enter BIOS setup to re-enter data.



Except when clearing the RTC RAM, never remove the cap on CLRTC jumper default position. Removing the cap will cause system boot failure!

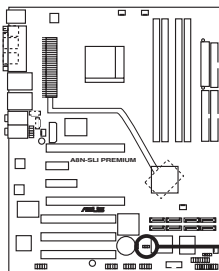

A8N-SLI PREMIUM Clear RTC RAM

CLRTC

1 2
Normal
(Default)

2 3
Clear CMOS



You do not need to clear the RTC when the system hangs due to overclocking. For system failure due to overclocking, use the C.P.R. (CPU Parameter Recall) feature. Shut down and reboot the system so the BIOS can automatically reset parameter settings to default values.

2.7 Connectors

2.7.1 Rear panel connectors

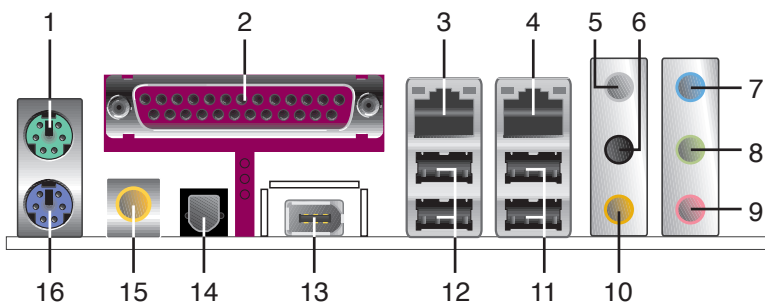

1. **PS/2 mouse port (green).** This port is for a PS/2 mouse.
2. **Parallel port.** This 25-pin port connects a parallel printer, a scanner, or other devices.
3. **LAN 2 (RJ-45) port.** Supported by the Marvell® 88E81001 Gigabit LAN controller, this port allows Gigabit connection to a Local Area Network (LAN) through a network hub.
4. **LAN 1 (RJ-45) port.** Supported by the NVIDIA® nForce™ 4 Gigabit MAC with external Marvell® PHY, this port allows Gigabit connection to a Local Area Network (LAN) through a network hub. Refer to the table below for the LAN port LED indications.

LAN port LED indications

ACT/LINK LED		SPEED LED	
Status	Description	Status	Description
OFF	No link	OFF	10 Mbps connection
GREEN	Linked	ORANGE	100 Mbps connection
BLINKING	Data activity	GREEN	1 Gbps connection

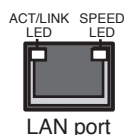

5. **Rear Speaker Out port (gray).** This port connects the rear speakers on a 4-channel, 6-channel, or 8-channel audio configuration.
6. **Side Speaker Out port (black).** This port connects the side speakers in an 8-channel audio configuration.
7. **Line In port (light blue).** This port connects the tape, CD, DVD player, or other audio sources.
8. **Line Out port (lime).** This port connects a headphone or a speaker. In 4-channel, 6-channel, and 8-channel configuration, the function of this port becomes Front Speaker Out.

9. **Microphone port (pink).** This port connects a microphone.
10. **Center/Subwoofer port (yellow orange).** This port connects the center/subwoofer speakers.



Refer to the audio configuration table below for the function of the audio ports in 2, 4, 6, or 8-channel configuration.

Audio 2, 4, 6, or 8-channel configuration

Port	Headset 2-channel	4-channel	6-channel	8-channel
Light Blue	Line In	Line In	Line In	Line In
Lime	Line Out	Front Speaker Out	Front Speaker Out	Front Speaker Out
Pink	Mic In	Mic In	Mic In	Mic In
Gray	•	Rear Speaker Out	Rear Speaker Out	Rear Speaker Out
Black	•	•	•	Side Speaker Out
Yellow Orange	•	•	Center/Subwoofer	Center/Subwoofer

11. **USB 2.0 ports 3 and 4.** These two 4-pin Universal Serial Bus (USB) ports are available for connecting USB 2.0 devices.
12. **USB 2.0 ports 1 and 2.** These two 4-pin Universal Serial Bus (USB) ports are available for connecting USB 2.0 devices.
13. **IEEE 1394a port.** This 6-pin IEEE 1394 port provides high-speed connectivity for audio/video devices, storage peripherals, PCs, or portable devices.
14. **Optical S/PDIF Out port.** This port connects an external audio output device via an optical S/PDIF cable.
15. **Coaxial S/PDIF Out port.** This port connects an external audio output device via a coaxial S/PDIF cable.
16. **PS/2 keyboard port (purple).** This port is for a PS/2 keyboard.

2.7.2 Internal connectors

1. Floppy disk drive connector (34-1 pin FLOPPY)

This connector is for the provided floppy disk drive (FDD) signal cable. Insert one end of the cable to this connector, then connect the other end to the signal connector at the back of the floppy disk drive.



The Pin 5 on the connector is removed to prevent incorrect cable connection when using an FDD cable with a covered Pin 5.

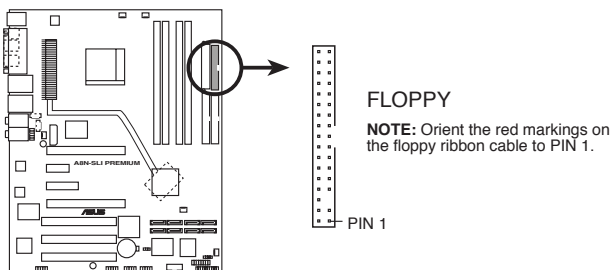

A8N-SLI PREMIUM Floppy disk drive connector

2. IDE connectors (40-1 pin PRI_IDE, SEC_IDE)

These connectors are for Ultra DMA 133/100/66 signal cables. The Ultra DMA 133/100/66 signal cable has three connectors: a blue connector for the primary IDE connector on the motherboard, a black connector for an Ultra DMA 133/100/66 IDE slave device (optical drive/hard disk drive), and a gray connector for an Ultra DMA 133/100/66 IDE master device (hard disk drive). If you install two hard disk drives, you must configure the second drive as a slave device by setting its jumper accordingly. Refer to the hard disk documentation for the jumper settings.



- The Pin 20 on the IDE connector is removed to match the covered hole on the Ultra DMA cable connector. This prevents incorrect insertion when you connect the IDE cable.
- Use the 80-conductor IDE cable for UltraDMA133/100/66 IDE devices.

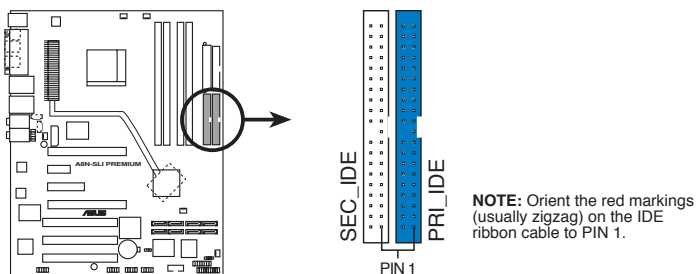

A8N-SLI PREMIUM IDE connectors

3. Serial ATA connectors (7-pin SATA1, SATA2, SATA3, SATA4)

Supported by the NVIDIA® nForce4™ chipset, these connectors are for the Serial ATA signal cables for Serial ATA hard disk drives that allows up to 3Gb/s of data transfer rate.



These connectors are set to SATA by default. In SATA mode, you can connect Serial ATA boot or data hard disk drives to these connectors. If you intent to create a Serial ATA RAID set using these connectors, enable the RAID function of each port from the NVRAID Configuration sub-menu item in the BIOS. See section “4.4.3 Onboard Devices Configuration” on pages 4-24 and 4-26 for details.

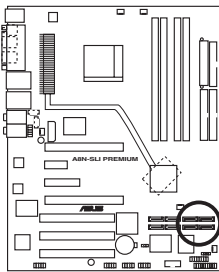

A8N-SLI PREMIUM SATA connectors

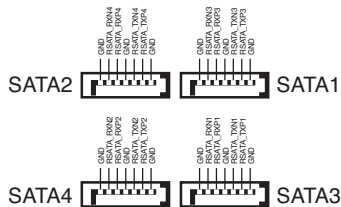

Important notes on Serial ATA

- The actual data transfer rate depends on the speed of Serial ATA hard disks installed.
- See Appendix for instructions on how to install the Serial ATA extension module.

4. Serial ATA RAID connectors (7-pin SATA_RAID1, SATA_RAID2, SATA_RAID3, SATA_RAID4)

Supported by the Silicon Image® Sil3114 RAID controller, these connectors are for Serial ATA signal cables. These connectors support up to four Serial ATA hard disk drives that can be configured as a disk array through the onboard Silicon Image Sil3114 SATA RAID controller. Refer to Chapter 5 for details on how to set up Serial ATA RAID configurations.



By default, the RAID function of these connectors are enabled. Disable the Silicon SATA controller item in the BIOS, if you are not configuring a set with these connectors. See section “4.4.3 Onboard Devices Configuration” on page 4-24 for details.

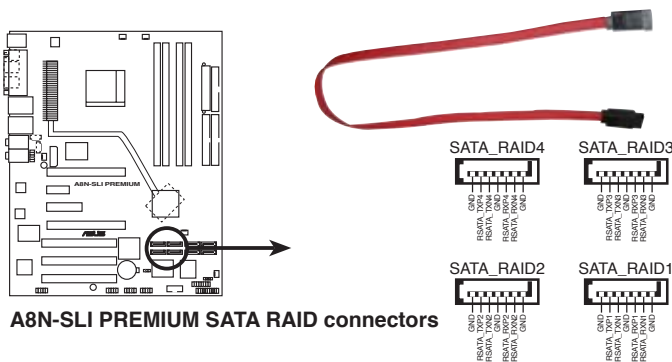

A8N-SLI PREMIUM SATA RAID connectors



- Before creating a RAID configuration, make sure that you have connected the Serial ATA cables to these connectors and have installed the Serial ATA hard disk drives; otherwise, you cannot enter the Silicon Image RAID utility and Serial ATA BIOS setup during POST.
- See Appendix for instructions on how to install the Serial ATA extension module.

5. CPU, Chassis, Chipset and Power fan connectors (3-pin CPU_FAN, 3-pin CHA2_FAN, 3-pin CHIP_FAN, 3-pin PWR_FAN, 3-pin CHA1_FAN)

The fan connectors support cooling fans of 350mA~2000mA (24 W max.) or a total of 1A~3.48A (41.76 W max.) at +12V. Connect the fan cables to the fan connectors on the motherboard, making sure that the black wire of each cable matches the ground pin of the connector.



- Do not forget to connect the fan cables to the fan connectors. Lack of sufficient air flow inside the system may damage the motherboard components. These are not jumpers! DO NOT place jumper caps on the fan connectors!
- The ASUS Q-Fan function is supported using the CPU Fan (CPU_FAN) and Chassis Fan 1 (CHA1_FAN) connectors only.
- The chipset fan is synchronized with the CPU fan.

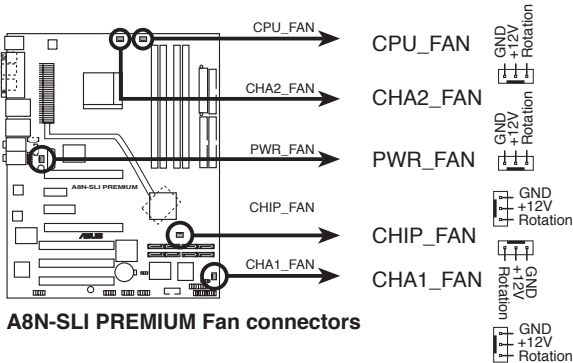

6. Serial port connector (10-1 pin COM1)

This connector is for a serial (COM) port. Connect the serial port module cable to this connector, then install the module to a slot opening at the back of the system chassis.

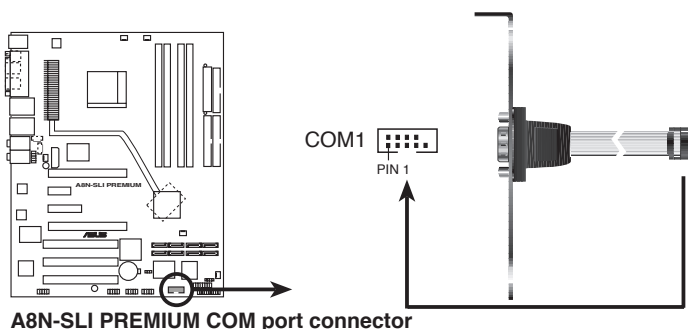

A8N-SLI PREMIUM COM port connector

7. USB connectors (10-1 pin USB56, USB78, USB910)

These connectors are for USB 2.0 ports. Connect the USB/GAME module cable to any of these connectors, then install the module to a slot opening at the back of the system chassis. These USB connectors comply with USB 2.0 specification that supports up to 480 Mbps connection speed.

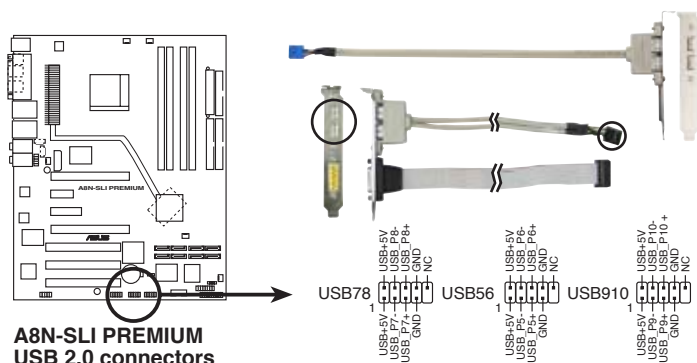

**A8N-SLI PREMIUM
USB 2.0 connectors**



Never connect a 1394 cable to the USB connectors. Doing so will damage the motherboard!

8. ATX power connectors (24-pin EATXPWR1, 4-pin ATX12V1, 4-pin EZ_PLUG)

These connectors are for an ATX power supply plugs. The power supply plugs are designed to fit these connectors in only one orientation. Find the proper orientation and push down firmly until the connectors completely fit.



- Do not forget to connect the 4-pin ATX +12 V power plug; otherwise, the system will not boot.
- When using two graphics cards, do not forget to connect the 4-pin ATX +12 V power plug to the EZ Plug™; otherwise, the system will be unstable. See page 6-5 for details.
- Use of a PSU with a higher power output is recommended when configuring a system with more power-consuming devices. The system may become unstable or may not boot up if the power is inadequate.
- Make sure that your power supply unit (PSU) can provide at least the minimum power required by your system. See the table below for details.

Power supply requirements

Components/Peripherals	Loading		
	Heavy	Normal	Light
AMD® K8 939-pin CPU type	Athlon 64 FX-55	Athlon 64 3800+	Athlon 64 3400+
PCIe™ x16 graphics cards	6800 Ultra x2	6800GT x2	6600GT x2
DDR DIMMs	4	2	2
HDD	4	2	2
Optical drive (DVD/CD-RW)	2	2	1
PCIe™ x1 card	1	0	0
PCI cards	3	2	1
IEEE 1394 devices	1	0	0
USB devices	6	4	3
Required +12V current	> 25A	> 20A	> 17A
Required wattage	>= 500W	>= 400W	>= 350W

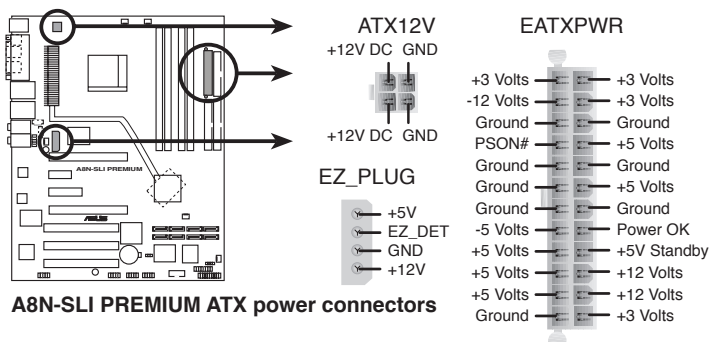

9. Internal audio connectors (4-pin CD, AUX)

These connectors allow you to receive stereo audio input from sound sources such as a CD-ROM, TV-tuner, or MPEG card.

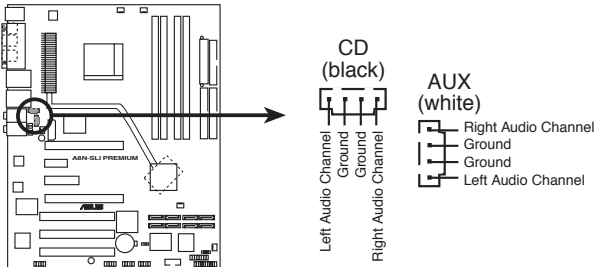

ASUS A8N-SLI PREMIUM Internal audio connectors



The function of these connectors are disabled under 8-channel mode.

10. GAME/MIDI port connector (16-1 pin GAME)

This connector is for a GAME/MIDI port. Connect the USB/GAME module cable to this connector, then install the module to a slot opening at the back of the system chassis. The GAME/MIDI port connects a joystick or game pad for playing games, and MIDI devices for playing or editing audio files.

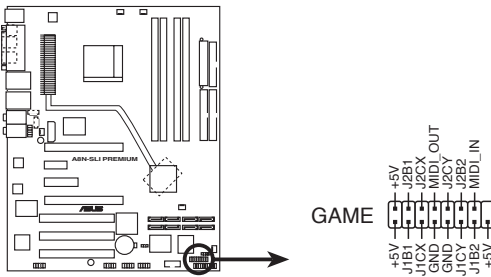

ASUS A8N-SLI PREMIUM Game connector

11. Chassis intrusion connector (4-1 pin CHASSIS)

This connector is for a chassis-mounted intrusion detection sensor or switch. Connect one end of the chassis intrusion sensor or switch cable to this connector. The chassis intrusion sensor or switch sends a high-level signal to this connector when a chassis component is removed or replaced. The signal is then generated as a chassis intrusion event.

By default, the pins labeled “Chassis Signal” and “Ground” are shorted with a jumper cap. Remove the jumper caps only when you intend to use the chassis intrusion detection feature.

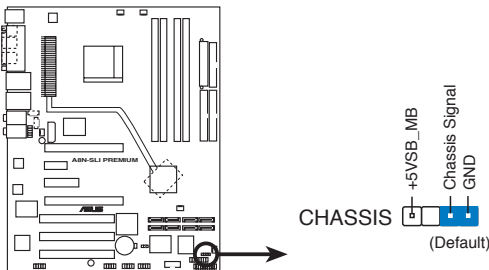

A8N-SLI PREMIUM Chassis intrusion connector

12. IEEE 1394 connector (10-1 pin IE1394_2)

This connector is for the IEEE 1394a module. Connect the IEEE 1394 module cable to this connector, then install the module to a slot opening at the back of the system chassis.

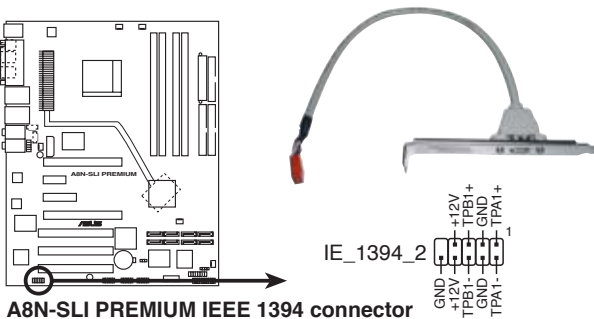

A8N-SLI PREMIUM IEEE 1394 connector



Never connect a USB cable to the IEEE 1394 connectors. Doing so will damage the motherboard!

13. Front panel audio connector (10-1 pin FP_AUDIO)

This connector is for a chassis-mounted front panel audio I/O module that supports legacy AC '97 audio standard. Connect one end of the front panel audio I/O module cable to this connector.

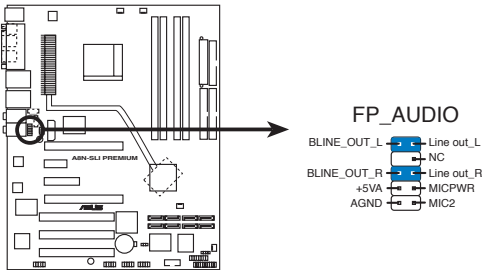

A8N-SLI PREMIUM Front panel audio connector

14. System panel connector (20-pin PANEL)

This connector supports several chassis-mounted functions.

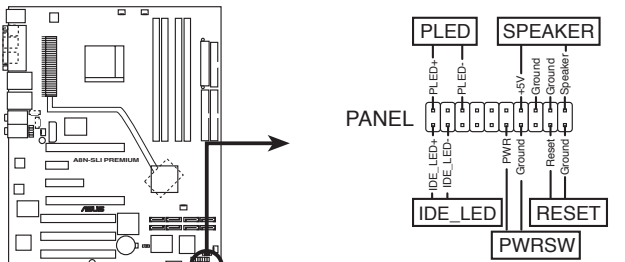

A8N-SLI PREMIUM System panel connector

* Requires an ATX power supply.



The system panel connector is color-coded for easy connection. Refer to the connector description below for details.

- **System power LED (Green 3-pin PLED)**

This 3-pin connector is for the system power LED. Connect the chassis power LED cable to this connector. The system power LED lights up when you turn on the system power, and blinks when the system is in sleep mode.

- **Hard disk drive activity (Red 2-pin IDE_LED)**

This 2-pin connector is for the HDD Activity LED. Connect the HDD Activity LED cable to this connector. The IDE LED lights up or flashes when data is read from or written to the HDD.

- **System warning speaker (Orange 4-pin SPEAKER)**
This 4-pin connector is for the chassis-mounted system warning speaker. The speaker allows you to hear system beeps and warnings.
- **Power/Soft-off button (Yellow 2-pin PWRSW)**
This connector is for the system power button. Pressing the power button turns the system ON or puts the system in SLEEP or SOFT-OFF mode depending on the BIOS settings. Pressing the power switch for more than four seconds while the system is ON turns the system OFF.
- **Reset button (Blue 2-pin RESET)**
This 2-pin connector is for the chassis-mounted reset button for system reboot without turning off the system power.

This chapter describes the power up sequence, the vocal POST messages, and ways of shutting down the system.

Powering up 3

Chapter summary

- 3.1 Starting up for the first time 3-1
- 3.2 Powering off the computer..... 3-2
- 3.3 ASUS POST Reporter™ 3-3

3.1 Starting up for the first time

1. After making all the connections, replace the system case cover.
2. Be sure that all switches are off.
3. Connect the power cord to the power connector at the back of the system chassis.
4. Connect the power cord to a power outlet that is equipped with a surge protector.
5. Turn on the devices in the following order:
 - a. Monitor
 - b. External SCSI devices (starting with the last device on the chain)
 - c. System power
6. After applying power, the system power LED on the system front panel case lights up. For systems with ATX power supplies, the system LED lights up when you press the ATX power button. If your monitor complies with “green” standards or if it has a “power standby” feature, the monitor LED may light up or switch between orange and green after the system LED turns on.

The system then runs the power-on self tests or POST. While the tests are running, the BIOS beeps (see BIOS beep codes table below) or additional messages appear on the screen. If you do not see anything within 30 seconds from the time you turned on the power, the system may have failed a power-on test. Check the jumper settings and connections or call your retailer for assistance.
7. At power on, hold down the <Delete> key to enter the BIOS Setup. Follow the instructions in Chapter 4.

3.2 Powering off the computer

3.2.1 Using the OS shut down function

If you are using Windows® 2000:

1. Click the **Start** button then click **Shut Down...**
2. Make sure that the **Shut Down** option button is selected, then click the **OK** button to shut down the computer.
3. The power supply should turn off after Windows® shuts down.

If you are using Windows® XP:

1. Click the **Start** button then select **Turn Off Computer**.
2. Click the **Turn Off** button to shut down the computer.
3. The power supply should turn off after Windows® shuts down.

3.2.2 Using the dual function power switch

While the system is ON, pressing the power switch for less than four seconds puts the system to sleep mode or to soft-off mode, depending on the BIOS setting. Pressing the power switch for more than four seconds lets the system enter the soft-off mode regardless of the BIOS setting. Refer to section “4.5 Power Menu” in Chapter 4 for details.

3.3 ASUS POST Reporter™

This motherboard includes the Winbond speech controller to support a special feature called the ASUS POST Reporter™. This feature lets you hear vocal messages during POST that alerts you of system events and boot status. In case of a boot failure, you will hear the specific cause of the problem.

These POST messages are customizable using the Winbond Voice Editor software that came with your package. You can record your own messages to replace the default messages.

3.3.1 Vocal POST messages

Following is a list of the default POST messages and the corresponding actions you can take:

POST Message	Action
No CPU installed	<ul style="list-style-type: none">• Install a supported processor to the CPU socket. See section “2.3 Central Processing Unit (CPU)” for details.
System failed CPU test	<ul style="list-style-type: none">• Check the CPU if properly installed.• Call ASUS technical support for assistance. See the ASUS contact information on the inside front cover of this user guide.
System failed memory test	<ul style="list-style-type: none">• Install supported DDR DIMMs into the memory sockets.• Check if the DIMMs on the DIMM sockets are properly installed.• Make sure that your DIMMs are not defective.• Refer to section “2.4 System memory” for instructions on installing a DIMM.
System failed VGA test	<ul style="list-style-type: none">• Install a PCI graphics card into one of the PCI slots, or a PCI Express AGP card into the PCI Express x16 slot.• Make sure that your graphics card is not defective.
System failed due to CPU	<ul style="list-style-type: none">• Check your CPU overclocking settings in the BIOS setup and restore the default CPU parameters.
No keyboard detected	<ul style="list-style-type: none">• Check if your keyboard is properly connected to the purple PS/2 connector on the rear panel.• See section “2.7.1 Rear panel connectors” for the location of the connector.
No IDE hard disk detected	<ul style="list-style-type: none">• Make sure you have connected an IDE hard disk drive to one of the IDE connectors on the motherboard.

POST Message	Action
CPU temperature too high	<ul style="list-style-type: none"> • Check if the CPU fan is working properly.
CPU fan failed	<ul style="list-style-type: none"> • Check the CPU fan and make sure it turns on after you apply power to the system. • Make sure that your CPU fan supports the fan speed detection function.
CPU voltage out of range	<ul style="list-style-type: none"> • Check your power supply and make sure it is not defective. • Call ASUS technical support for assistance. See the "ASUS contact information" on the inside front cover of this user guide.
Computer now booting from operating system	<ul style="list-style-type: none"> • No action required



You can enable or disable the ASUS POST Reporter™ in the Speech Configuration option in the BIOS setup. See section 4.4.8 for details.

3.3.2 Winbond Voice Editor

The Winbond Voice Editor software allows you to customize the vocal POST messages. You can install this application from the support CD.



To avoid conflicts, do not run the Winbond Voice Editor while running the ASUS PC Probe application.

Launching the Voice Editor

You can launch the program from the Windows® desktop by clicking **Start > All Programs > Winbond Voice Editor > Voice Editor**.

The Winbond Voice Editor screen appears.

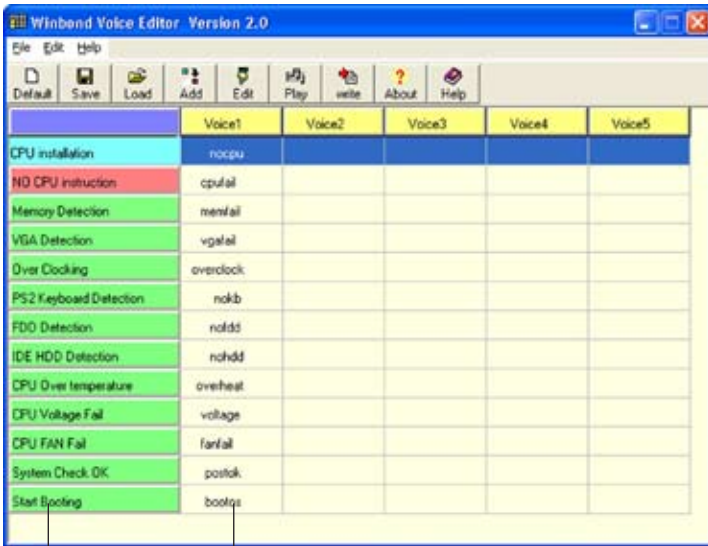

POST Events Default Messages

Playing the default wave files

To play the default wave files, simply click on a POST event on the left side of the screen, then click the Play button.



The default language setting is English.

Changing the default language

To change the default language:

1. Click the **Load** button from the Voice Editor main window. A window with the available languages appears.

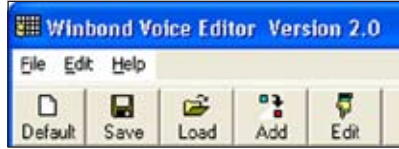

2. Select your desired language, then click **Open**.

The event messages for the language you selected appear on the Voice Editor main window.



Not all events on some languages have a corresponding message due to file size constraints.

3. Click the **Write** button from the Voice Editor main window to update the EEPROM.
4. Click **Yes** to confirm.

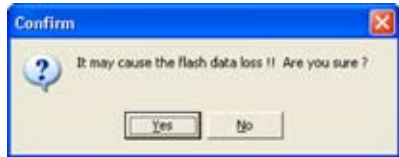

The next time you boot your computer, the ASUS Post Reporter announces the messages in the selected language.

Customizing your POST messages

The Voice Editor application allows you to record your own POST messages if your language is not supported or if you wish to replace the pre-installed wave files.

To customize your POST messages.

1. Launch the Voice Editor application and note the list of POST events on the leftmost column of the screen.
2. Prepare your message for each event.
3. Use a recording software (e.g. Windows® Recorder) to record your messages, then save the messages as wave files (.WAV).



- The total compressed size for all the wave files must not exceed 1Mbit, so keep your messages as short as possible.
- To keep file sizes small, save your files at a low quality. For example, use 8-bit, mono quality at 22Khz sampling rate.
- Create a separate folder for your wave files so you can locate them easily.

4. From the Voice Editor screen, click the **Add** button to display the **Add Wave File** window.
5. Copy the wave files that you recorded to the database, then close the window when done.



6. Select a POST event on the Voice Editor main window, then click the **Edit** button. The **Event Sound Editor** window appears.
7. Locate and select your wave file for the event, then click on the arrow opposite Voice1. The file you select appears on the space next to it.
8. Click **OK** to return to the Voice Editor main window.
9. Do steps 6 to 8 for the other events.



10. When done, click **Save**. A window appears prompting you to save your configuration.
11. Type a file name with an **.flh** extension, then click **Save**.



12. Click the **Write** button to compress the file and copy into the EEPROM.
13. Click **Yes** on the confirmation window that appears.

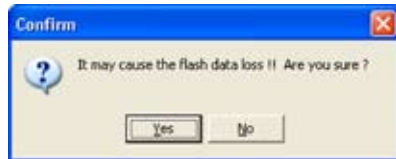

If you receive an error message telling you that the files exceed the total allowable size, do any or all of the following:

- Shorten your messages.
- Save the wave files at a lower quality
- Do not include seldom-used events like FDD Detection, IDE HDD Detection, etc.

This chapter tells how to change the system settings through the BIOS Setup menus. Detailed descriptions of the BIOS parameters are also provided.

BIOS setup **4**

Chapter summary

4.1	Managing and updating your BIOS	4-1
4.2	BIOS setup program.....	4-11
4.3	Main menu.....	4-15
4.4	Advanced menu	4-20
4.5	Power menu	4-35
4.6	Boot menu	4-40
4.7	Exit menu.....	4-46

4.1 Managing and updating your BIOS

The following utilities allow you to manage and update the motherboard Basic Input/Output System (BIOS) setup.

1. **Award BIOS Flash Utility** (Updates the BIOS in DOS mode using a bootable floppy disk.)
2. **ASUS CrashFree BIOS 2** (Updates the BIOS using a bootable floppy disk or the motherboard support CD when the BIOS file fails or gets corrupted.)
3. **ASUS EZ Flash** (Updates the BIOS in DOS using a floppy disk or the motherboard support CD.)
4. **ASUS Update** (Updates the BIOS in Windows® environment.)

Refer to the corresponding sections for details on these utilities.



Save a copy of the original motherboard BIOS file to a bootable floppy disk in case you need to restore the BIOS in the future. Copy the original motherboard BIOS using the ASUS Update or AwardBIOS Flash utilities.

4.1.1 Creating a bootable floppy disk

1. Do either one of the following to create a bootable floppy disk.

DOS environment

- a. Insert a 1.44MB floppy disk into the drive.
- b. At the DOS prompt, type `format a: /s` then press <Enter>.

Windows® XP environment

- a. Insert a 1.44 MB floppy disk to the floppy disk drive.
- b. Click **Start** from the Windows® desktop, then select **My Computer**.
- c. Select the 3 1/2 Floppy Drive icon.
- d. Click **File** from the menu, then select **Format**. A **Format 3 1/2 Floppy Disk** window appears.
- e. Select **Create an MS-DOS startup disk** from the format options field, then click **Start**.

Windows® 2000 environment

To create a set of boot disks for Windows® 2000:

- a. Insert a formatted, high density 1.44 MB floppy disk into the drive.
- b. Insert the Windows® 2000 CD to the optical drive.

- c. Click Start, then select **Run**.
 - d. From the Open field, type
D:\bootdisk\makeboot a:
 assuming that D: is your optical drive.
 - e. Press <Enter>, then follow screen instructions to continue.
2. Copy the original or the latest motherboard BIOS file to the bootable floppy disk.

4.1.2 Updating the BIOS

The Basic Input/Output System (BIOS) can be updated using the AwardBIOS Flash Utility. Follow these instructions to update the BIOS using this utility.

1. Download the latest BIOS file from the ASUS web site. Rename the file to **A8NSLI-B.BIN** and save it to a floppy disk.



Save only the updated BIOS file in the floppy disk to avoid loading the wrong BIOS file.

2. Copy the AwardBIOS Flash Utility (awdflash.exe) from the Software folder of the support CD to the floppy disk with the latest BIOS file.
3. Boot the system in DOS mode using the bootable floppy disk you created earlier.
4. When the **A:>** appears, replace the bootable floppy disk with the floppy disk containing the new BIOS file and the Award BIOS Flash Utility.
5. At the prompt, type **awdflash** then press <Enter>. The Award BIOS Flash Utility screen appears.

```

AwardBIOS Flash Utility for ASUS V1.01
(C) Phoenix Technologies Ltd. All Rights Reserved

For NF-KC804-A8N-SLI-00      DATE: 11/18/2004
Flash Type - SST 49LF004A/B /3.3V

File Name to Program: 

Message: Please input File Name!

```

6. Type the BIOS file name in the **File Name to Program** field, then press <Enter>.

```
AwardBIOS Flash Utility for ASUS V1.01
(C) Phoenix Technologies Ltd. All Rights Reserved

For NF-KC804-A8N-SLI-00      DATE: 11/18/2004
Flash Type - SST 49LF004A/B /3.3V

File Name to Program: 1001.bin

Message: Do You Want To Save Bios (Y/N)
```

7. Press <N> when the utility prompts you to save the current BIOS file. The following screen appears.
8. The utility verifies the BIOS file in the floppy disk and starts flashing the BIOS file.

```
AwardBIOS Flash Utility for ASUS V1.01
(C) Phoenix Technologies Ltd. All Rights Reserved

For NF-KC804-A8N-SLI-00      DATE: 11/18/2004
Flash Type - SST 49LF004A/B /3.3V

File Name to Program: 1001.bin

Program Flashing Memory - OFE00 OK

Write OK      No Update      Write Fail

Warning: Don't Turn Off Power Or Reset System!
```



Do not turn off or reset the system during the flashing process!

9. The utility displays a **Flashing Complete** message indicating that you have successfully flashed the BIOS file. Remove the floppy disk then press <F1> to restart the system.

```
AwardBIOS Flash Utility for ASUS V1.01
(C) Phoenix Technologies Ltd. All Rights Reserved

For NF-KC804-A8N-SLI-00      DATE: 11/18/2004
Flash Type - SST 49LF004A/B /3.3V

File Name to Program: 1001.bin

Flashing Complete
Press <F1> to Continue

Write OK      No Update      Write Fail

F1 Reset
```

4.1.3 Saving the current BIOS file

You can use the AwardBIOS Flash Utility to save the current BIOS file. You can load the current BIOS file when the BIOS file gets corrupted during the flashing process.



Make sure that the floppy disk has enough disk space to save the file.

To save the current BIOS file using the AwardBIOS Flash Utility:

1. Follow steps 1 to 6 of the previous section.
2. Press <Y> when the utility prompts you to save the current BIOS file. The following screen appears.

```
AwardBIOS Flash Utility for ASUS V1.01
(C) Phoenix Technologies Ltd. All Rights Reserved

For NF-KC804-A8N-SLI-00      DATE: 11/18/2004
Flash Type - SST 49LF004A/B /3.3V

File Name to Program: I001.bin
Save current BIOS as:

Message:
```

3. Type a filename for the current BIOS file in the **Save current BIOS as** field, then press <Enter>.

```
AwardBIOS Flash Utility for ASUS V1.01
(C) Phoenix Technologies Ltd. All Rights Reserved

For NF-KC804-A8N-SLI-00      DATE: 11/18/2004
Flash Type - SST 49LF004A/B /3.3V

File Name to Program: I001.bin
Checksum: DAD6H
Save current BIOS as: old.bin

Message: Please Wait!
```

4. The utility saves the current BIOS file to the floppy disk, then returns to the BIOS flashing process.

```
AwardBIOS Flash Utility for ASUS V1.01
(C) Phoenix Technologies Ltd. All Rights Reserved

For NF-KC804-A8N-SLI-00      DATE: 11/18/2004
Flash Type - SST 49LF004A/B /3.3V

File Name to Program: I001.bin
Now Backup System BIOS to
File!

Message: Please Wait!
```

4.1.4 ASUS CrashFree BIOS 2 utility

The ASUS CrashFree BIOS 2 is an auto recovery tool that allows you to restore the BIOS file when it fails or gets corrupted during the updating process. You can update a corrupted BIOS file using the motherboard support CD or the floppy disk that contains the updated BIOS file.



Prepare the motherboard support CD or the floppy disk containing the updated motherboard BIOS before using this utility.

Recovering the BIOS from the support CD

To recover the BIOS from the support CD:

1. Turn on the system.
2. Insert the motherboard support CD to the optical drive.
3. The utility displays the following message and automatically checks the CD for the BIOS file.

```
Copyright (c) 2000, Award Software, Inc.
```

```
BIOS ROM checksum error  
Detecting IDE ATAPI device...
```

When found, the utility reads the BIOS file and starts flashing the corrupted BIOS file.

```
Award BootBlock BIOS v1.0  
Copyright (c) 2000, Award Software, Inc.  
  
BIOS ROM checksum error  
Detecting IDE ATAPI device...  
Found CDROM, try to Boot from it... Pass
```



DO NOT shut down or reset the system while updating the BIOS! Doing so can cause system boot failure!

4. Restart the system after the utility completes the updating process.

Recovering the BIOS from a floppy disk

To recover the BIOS from the support CD:

1. Remove any CD from the optical drive, then turn on the system.
2. Insert the floppy disk with the original or updated BIOS file to the floppy disk drive.
3. The utility displays the following message and automatically checks the floppy disk for the original or updated BIOS file.

```
Award BootBlock BIOS v1.0
Copyright (c) 2000, Award Software, Inc.

BIOS ROM checksum error
Detecting IDE ATAPI device...
```

When no CD is found, the utility automatically checks the optical drive for the original or updated BIOS file. The utility then updates the corrupted BIOS file.

```
Award BootBlock BIOS v1.0
Copyright (c) 2000, Award Software, Inc.

BIOS ROM checksum error
Detecting IDE ATAPI device...
  Found CDRom, try to Boot from it... Fail

Detecting floppy drive A media...
```



DO NOT shut down or reset the system while updating the BIOS! Doing so can cause system boot failure!

4. Restart the system after the utility completes the updating process.



The recovered BIOS may not be the latest BIOS version for this motherboard. Visit the ASUS website (www.asus.com) to download the latest BIOS file.

4.1.5 ASUS EZ Flash utility

The ASUS EZ Flash feature allows you to update the BIOS without having to go through the long process of booting from a floppy disk and using a DOS-based utility. The EZ Flash utility is built-in the BIOS chip so it is accessible by pressing <Alt> + <F2> during the Power-On Self Tests (POST).

To update the BIOS using EZ Flash:

1. Visit the ASUS website (www.asus.com) to download the latest BIOS file for the motherboard.
2. Save the BIOS file to a floppy disk, then restart the system.
3. Press <Alt> + <F2> during POST to display the following.

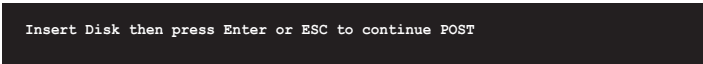

Insert Disk then press Enter or ESC to continue POST

4. Insert the floppy disk that contains the BIOS file to the floppy disk drive then press <Enter>. The following screen appears.

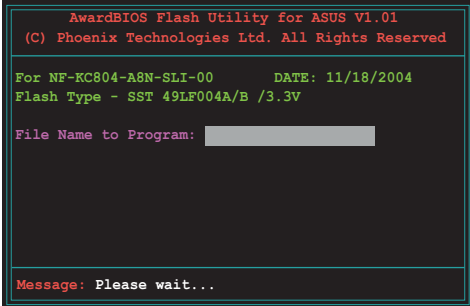

```
AwardBIOS Flash Utility for ASUS V1.01
(C) Phoenix Technologies Ltd. All Rights Reserved

For NF-KC804-A8N-SLI-00      DATE: 11/18/2004
Flash Type - SST 49LF004A/B /3.3V

File Name to Program: 

Message: Please wait...
```

5. When the correct BIOS file is found, EZ Flash performs the BIOS update process and automatically reboots the system when done.



Do not shutdown or reset the system while updating the BIOS to prevent system boot failure!

4.1.6 ASUS Update utility

The ASUS Update is a utility that allows you to manage, save, and update the motherboard BIOS in Windows® environment. The ASUS Update utility allows you to:

- Save the current BIOS file
- Download the latest BIOS file from the Internet
- Update the BIOS from an updated BIOS file
- Update the BIOS directly from the Internet, and
- View the BIOS version information.

This utility is available in the support CD that comes with the motherboard package.



ASUS Update requires an Internet connection either through a network or an Internet Service Provider (ISP).

Installing ASUS Update

To install ASUS Update:

1. Place the support CD in the optical drive. The **Drivers** menu appears.
2. Click the **Utilities** tab, then click **Install ASUS Update Vx.XX.XX**. See page 5-3 for the **Utilities** screen menu.
3. The ASUS Update utility is copied to your system.



Quit all Windows® applications before you update the BIOS using this utility.

Updating the BIOS through the Internet

To update the BIOS through the Internet:

1. Launch the ASUS Update utility from the Windows® desktop by clicking **Start > Programs > ASUS > ASUSUpdate > ASUSUpdate**. The ASUS Update main window appears.

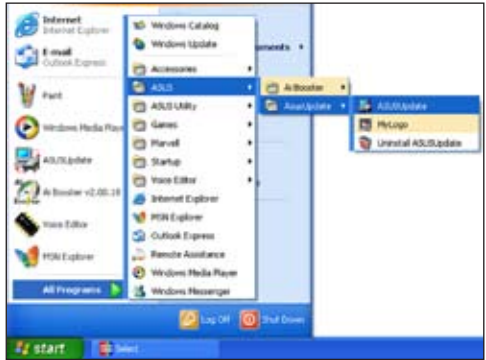

2. Select **Update BIOS from the Internet** option from the drop-down menu, then click **Next**.



3. Select the ASUS FTP site nearest you to avoid network traffic, or click **Auto Select**. Click **Next**.

- From the FTP site, select the BIOS version that you wish to download. Click **Next**.
- Follow the screen instructions to complete the update process.



The ASUS Update utility is capable of updating itself through the Internet. Always update the utility to avail all its features.



Updating the BIOS through a BIOS file

To update the BIOS through a BIOS file:

- Launch the ASUS Update utility from the Windows® desktop by clicking **Start > Programs > ASUS > ASUSUpdate > ASUSUpdate**. The ASUS Update main window appears.
- Select **Update BIOS from a file** option from the drop-down menu, then click **Next**.



- Locate the BIOS file from the **Open** window, then click **Open**.
- Follow the screen instructions to complete the update process.

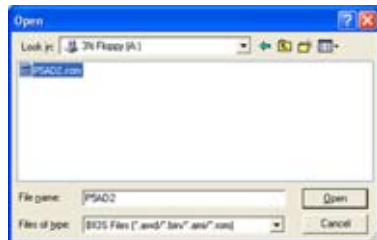

4.2 BIOS setup program

This motherboard supports a programmable Low-Pin Count (LPC) chip that you can update using the provided utility described in section “4.1 Managing and updating your BIOS.”

Use the BIOS Setup program when you are installing a motherboard, reconfiguring your system, or prompted to “Run Setup”. This section explains how to configure your system using this utility.

Even if you are not prompted to use the Setup program, you can change the configuration of your computer in the future. For example, you can enable the security password feature or change the power management settings. This requires you to reconfigure your system using the BIOS Setup program so that the computer can recognize these changes and record them in the CMOS RAM of the LPC chip.

The LPC chip on the motherboard stores the Setup utility. When you start up the computer, the system provides you with the opportunity to run this program. Press during the Power-On Self-Test (POST) to enter the Setup utility; otherwise, POST continues with its test routines.

If you wish to enter Setup after POST, restart the system by pressing <Ctrl>+<Alt>+<Delete>, or by pressing the reset button on the system chassis. You can also restart by turning the system off and then back on. Do this last option only if the first two failed.

The Setup program is designed to make it as easy to use as possible. Being a menu-driven program, it lets you scroll through the various sub-menus and make your selections from the available options using the navigation keys.



- The default BIOS settings for this motherboard apply for most conditions to ensure optimum performance. If the system becomes unstable after changing any BIOS settings, load the default settings to ensure system compatibility and stability. Select the **Load Default Settings** item under the Exit Menu. See section “4.7 Exit Menu.”
 - The BIOS setup screens shown in this section are for reference purposes only, and may not exactly match what you see on your screen.
 - Visit the ASUS website (www.asus.com) to download the latest BIOS file for this motherboard.
-

4.2.1 BIOS menu screen

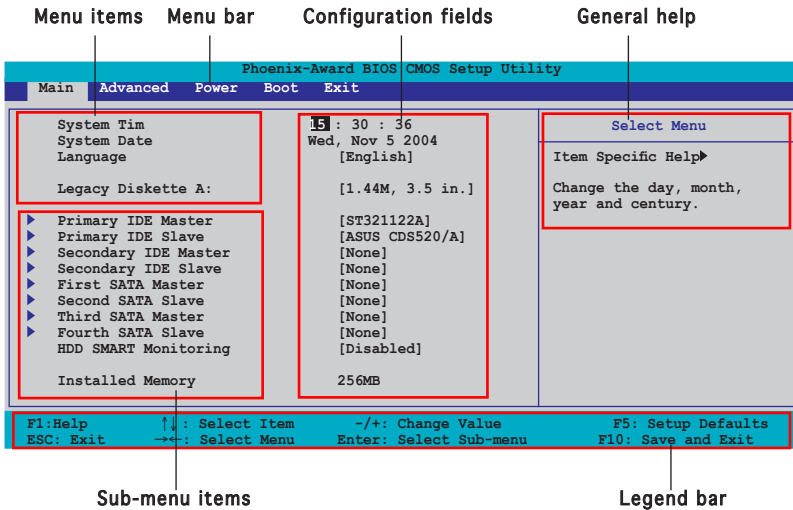

4.2.2 Menu bar

The menu bar on top of the screen has the following main items:

- Main** For changing the basic system configuration
- Advanced** For changing the advanced system settings
- Power** For changing the advanced power management (APM) configuration
- Boot** For changing the system boot configuration
- Exit** For selecting the exit options and loading default settings

To select an item on the menu bar, press the right or left arrow key on the keyboard until the desired item is highlighted.



- The BIOS setup screens shown in this chapter are for reference purposes only, and may not exactly match what you see on your screen.
- Visit the ASUS website (www.asus.com) to download the latest BIOS information.

4.2.3 Legend bar

At the bottom of the Setup screen is a legend bar. The keys in the legend bar allow you to navigate through the various setup menus. The following table lists the keys found in the legend bar with their corresponding functions.

Navigation Key	Function
<F1>	Displays the General Help screen
<F5>	Loads setup default values
<Esc>	Exits the BIOS setup or returns to the main menu from a sub-menu
Left or Right arrow	Selects the menu item to the left or right
Up or Down arrow	Moves the highlight up or down between fields
Page Down or - (minus)	Scrolls backward through the values for the highlighted field
Page Up or + (plus)	Scrolls forward through the values for the highlighted field
<Enter>	Brings up a selection menu for the highlighted field
<F10>	Saves changes and exit

4.2.4 Menu items

The highlighted item on the menu bar displays the specific items for that menu. For example, selecting **Main** shows the Main menu items.

The other items (Advanced, Power, Boot, and Exit) on the menu bar have their respective menu items.

4.2.5 Sub-menu items

A solid triangle before each item on any menu screen means that the item has a sub-menu. To display the sub-menu, select the item and press <Enter>.

4.2.6 Configuration fields

These fields show the values for the menu items. If an item is user-configurable, you can change the value of the field opposite the item. You cannot select an item that is not user-configurable.

A configurable field is enclosed in brackets, and is highlighted when selected. To change the value of a field, select it then press <Enter> to display a list of options. Refer to “4.2.7 Pop-up window.”

4.2.7 Pop-up window

Select a menu item then press <Enter> to display a pop-up window with the configuration options for that item.

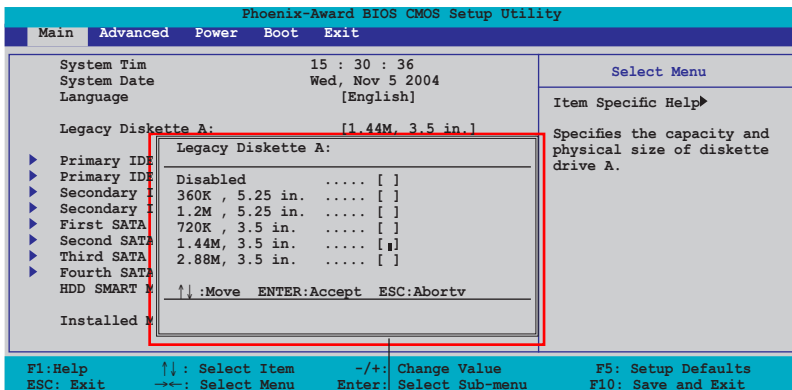

Pop-up menu

4.2.8 General help

At the top right corner of the menu screen is a brief description of the selected item.

4.3 Main menu

When you enter the BIOS Setup program, the Main menu screen appears, giving you an overview of the basic system information.



Refer to section “4.2.1 BIOS menu screen” for information on the menu screen items and how to navigate through them.

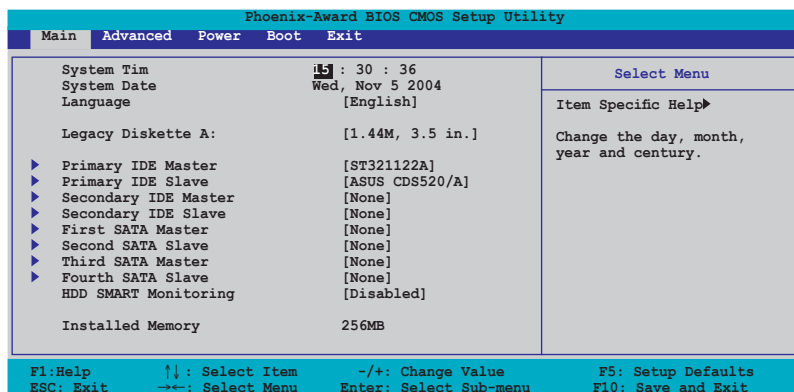

4.3.1 System Time [xx:xx:xxxx]

Allows you to set the system time.

4.3.2 System Date [Day xx/xx/xxxx]

Allows you to set the system date.

4.3.3 Language [English]

Allows you to choose the BIOS language version from the options. Configuration options: [Français] [German] [English]

4.3.4 Legacy Diskette A [1.44M, 3.5 in.]

Sets the type of floppy drive installed. Configuration options: [Disabled] [360K, 5.25 in.] [1.2M, 5.25 in.] [720K, 3.5 in.] [1.44M, 3.5 in.] [2.88M, 3.5 in.]

4.3.5 Primary and Secondary IDE Master/Slave

While entering Setup, the BIOS automatically detects the presence of IDE devices. There is a separate sub-menu for each IDE device. Select a device item then press <Enter> to display the IDE device information.

Phoenix-Award BIOS CMOS Setup Utility		
Main		
	Primary IDE Master	Select Menu
Primary IDE Master	[Auto]	Item Specific Help▶▶
Access Mode	[Auto]	Press [Enter] to select
Capacity	xxxxx MB	
Cylinder	xxxxx	
Head	xx	
Sector	xx	
PIO Mode	[Auto]	
UDMA Mode	[Auto]	
Transfer Mode	xxxxxxx	

F1:Help ↑↓: Select Item -/+ : Change Value F5: Setup Defaults
ESC: Exit →←: Select Menu Enter: Select Sub-menu F10: Save and Exit

The BIOS automatically detects the values opposite the dimmed items (Capacity, Cylinder, Head, Sector and Transfer Mode). These values are not user-configurable. These items show N/A if no IDE device is installed in the system.

Primary IDE Master/Slave [Auto]; Secondary IDE Master/Slave [Auto]

Select [Auto] to automatically detect an IDE hard disk drive. If automatic detection is successful, the BIOS automatically fills in the correct values for the remaining fields on this sub-menu. If the hard disk was already formatted on a previous system, the setup BIOS may detect incorrect parameters. Select [Manual] to manually enter the IDE hard disk drive parameters. If no drive is installed select [None].

Configuration options: [None] [Auto] [Manual]

Access Mode [Auto]

The default [Auto] allows automatic detection of an IDE hard disk drive. Select [CHS] for this item if you set the IDE Primary Master/Slave to [Manual]. Configuration options: [CHS] [LBA] [Large] [Auto]



Before attempting to configure a hard disk drive, make sure you have the correct configuration information supplied by the drive manufacturer. Incorrect settings may cause the system to fail to recognize the installed hard disk.

Capacity

Displays the auto-detected hard disk capacity. This item is not configurable.

Cylinder

Shows the number of the hard disk cylinders. This item is not configurable.

Head

Shows the number of the hard disk read/write heads. This item is not configurable.

Sector

Shows the number of sectors per track. This item is not configurable.

PIO Mode

Sets the PIO mode for the IDE device.

Configuration options: [Auto] [Mode 0] [Mode 1] [Mode 2] [Mode 3] [Mode 4]

UDMA Mode

Disables or sets the UDMA mode. Configuration options: [Disabled] [Auto]

Transfer Mode

Shows the Transfer mode. This item is not configurable.



After entering the IDE hard disk drive information into BIOS, use a disk utility, such as FDISK, to partition and format new IDE hard disk drives. This is necessary so that you can write or read data from the hard disk. Make sure to set the partition of the Primary IDE hard disk drives to active.

4.3.6 First, Second, Third, Fourth SATA Master

While entering Setup, the BIOS automatically detects the presence of Serial ATA devices. There is a separate sub-menu for each SATA device. Select a device item then press <Enter> to display the SATA device information.

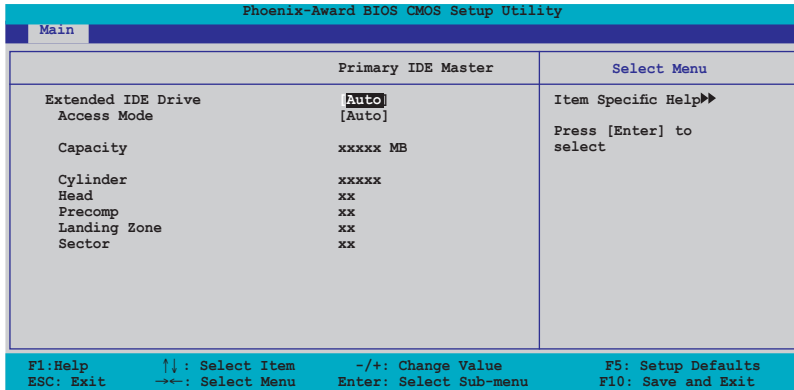

The BIOS automatically detects the values opposite the dimmed items (Capacity, Cylinder, Head, Precomp, Landing Zone and Sector). These values are not user-configurable. These items show 0 if no SATA device is installed in the system.

Extended Drive

Selects the type of fixed disk connected to the system.
Configuration options: [None] [Auto]

Access Mode

Sets the sector addressing mode. Configuration options: [Large] [Auto]



Before attempting to configure a hard disk drive, make sure you have the correct configuration information supplied by the drive manufacturer. Incorrect settings may cause the system to fail to recognize the installed hard disk.

Capacity

Displays the auto-detected hard disk capacity. This item is not configurable.

Cylinder

Shows the number of the hard disk cylinders. This item is not configurable.

Head

Shows the number of the hard disk read/write heads. This item is not configurable.

Precomp

Shows the number of precomp per track. This item is not configurable.

Landing Zone

Shows the number of landing zone per track. This item is not configurable.

Sector

Shows the number of sectors per track. This item is not configurable.



After entering the IDE hard disk drive information into BIOS, use a disk utility, such as FDISK, to partition and format new IDE hard disk drives. This is necessary so that you can write or read data from the hard disk. Make sure to set the partition of the Primary IDE hard disk drives to active.

4.3.7 HDD SMART Monitoring

Allows you to enable or disable the HDD Self-Monitoring Analysis and Reporting Technology (SMART) feature.

Configuration options: [Disabled] [Enabled]

4.3.8 Installed Memory

Shows the size of installed memory.

4.4 Advanced menu

The Advanced menu items allow you to change the settings for the CPU and other system devices.



Take caution when changing the settings of the Advanced menu items. Incorrect field values can cause the system to malfunction.

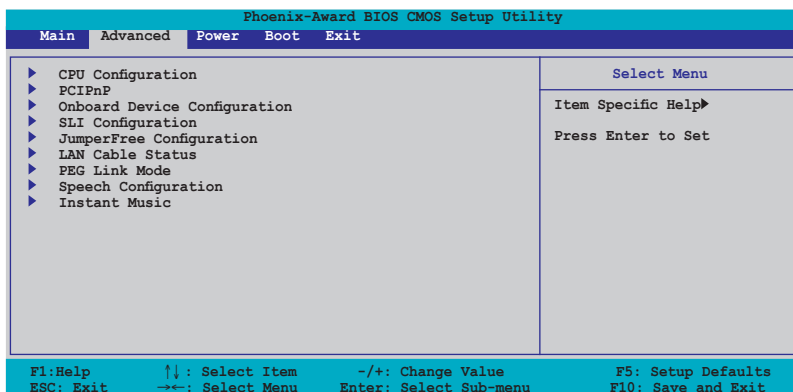

4.4.1 CPU Configuration

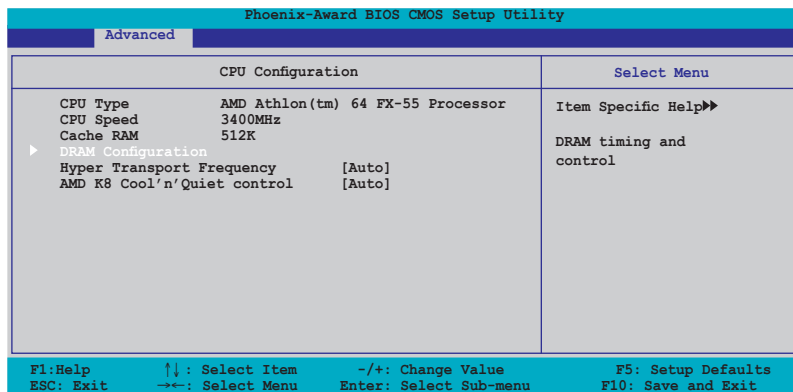

DRAM Configuration

The items in this sub-menu show the DRAM-related information auto-detected by the BIOS.

Phoenix-Award BIOS CMOS Setup Utility	
Advanced	
DRAM Configuration	Select Menu
DRAM Over 4G Remapping	[Disabled]
Max Memclock (MHz)	[Auto]
1T/2T Memory Timing	[Auto]
CAS# latency (Tcl)	[Auto]
RAS# to CAS# delay (Trcd)	[Auto]
Min RAS# active time (Tras)	[Auto]
Row precharge Time (Trp)	[Auto]
Row Cycle Time (Trc)	[Auto]
Row Refresh Cycle Time (Trfc)	[Auto]
Write Recovery Time (Twr)	[Auto]
Read-to-Write Delay (Trwt)	[Auto]
Item Specific Help▶▶▶	
Place an artificial memory clock limit on the system. Memory is prevented from running faster than this frequency.	
F1: Help	↑↓: Select Item
ESC: Exit	←→: Select Menu
-/+ : Change Value	Enter: Select Sub-menu
F5: Setup Defaults	F10: Save and Exit

DRAM Over 4G Remapping [Disabled]

Enables or disables DRAM remapping when using 4G of system memory. Configuration options: [Disabled] [Enabled]

Max Memclock (MHz) [Auto]

Sets the maximum operating memory clock.
Configuration options: [Auto] [DDR200] [DDR266] [DDR333] [DDR400] [DDR400] [DDR433] [DDR466] [DDR500] [DDR533] [DDR550] [DDR600]

1T/2T Memory Timing [Auto]

Sets the memory timing. Configuration options: [Auto] [1T] [2T]

CAS# latency (Tcl) [Auto]

Sets the CAS# latency.
Configuration options: [Auto] [2.0] [2.5] [3.0]

RAS# to CAS# delay (Trcd) [Auto]

Sets the RAS# to CAS# delay to Rd/Wr command on the same bank.
Configuration options: [Auto] [2] [3] [4] [5] [6] [7]

Row precharge Time (Trp) [Auto]

Sets the Row precharge time. Precharge to Active or Auto-Refresh of the same bank. Configuration options: [Auto] [2] [3] [4] [5] [6]

Row Cycle Time (Trc) [Auto]

Sets the row cycle time. Configuration options: [Auto] [7] [8] [9] [10] [11] [12] [13]

Row Refresh Cycle Time (Trfc) [Auto]

Sets the row refresh cycle time. Configuration options: [Auto] [9] [10] [11] [12] [13] [14] [15]

Write Recovery Time (Twr) [Auto]

Sets the write recovery time. Configuration options: [Auto] [2] [3]

Read-to-Write Delay (Trwt) [Auto]

Sets the read-to-write delay. Configuration options: [Auto] [1] [2] [3] [4] [5] [6]

Master ECC Enable [Disabled]

Enables or disables the master ECC function.
Configuration options: [Disabled] [Enabled]

Hyper Transport Frequency [Auto]

Sets the Hyper Transport frequency.
Configuration options: [Auto] [1x] [2x] [3x] [4x] [5x] [Auto]

AMD K8 Cool'n'Quiet control [Disabled]

Enables or disables the AMD Cool 'n' Quiet! technology.
Configuration options: [Disabled] [Enabled]

4.4.2 PCIPnP

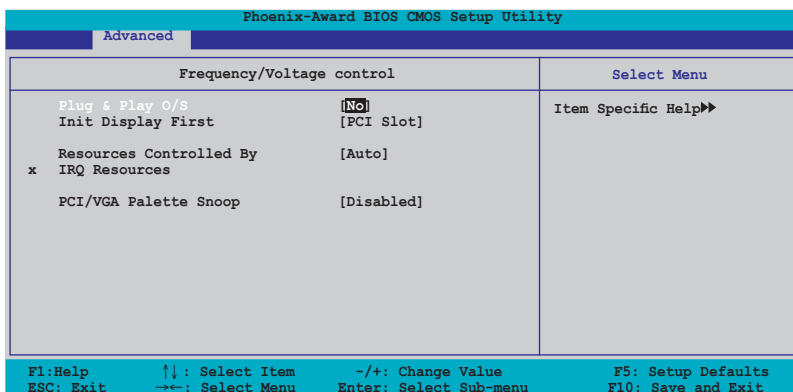

Plug & Play O/S [No]

When set to [No], the BIOS configures all the devices in the system. When set to [Yes] and if you install a Plug and Play operating system, the operating system configures the Plug and Play devices not required for boot. Configuration options: [No] [Yes]

Resources Controlled By [Auto]

When set to [Auto], the BIOS automatically configures all the boot and Plug and Play compatible devices. Set to [Manual] if you want to assign the IRQ DMA and memory base address fields. Configuration options: [Auto] [Manual]



When the item Resources Controlled By is set to [Auto], the item IRQ Resources is grayed out and not user-configurable. Refer to the section “IRQ Resources” for information on how to enable this item.

IRQ Resources

This sub-menu is activated only when the Resources Controlled By item is set to Manual.

Phoenix-Award BIOS CMOS Setup Utility		
Advanced		
IRQ Resources		Select Menu
IRQ-3 assigned to	[PCI Device]	Item Specific Help▶▶▶
IRQ-4 assigned to	[PCI Device]	Legacy ISA for devices compliant with the original PC AT bus specification, PCI/ISA PnP for devices compliant with the Plug and Play standard whether designed for PCI or ISA bus architecture
IRQ-5 assigned to	[PCI Device]	
IRQ-7 assigned to	[PCI Device]	
IRQ-9 assigned to	[PCI Device]	
IRQ-10 assigned to	[PCI Device]	
IRQ-11 assigned to	[PCI Device]	
IRQ-12 assigned to	[PCI Device]	
IRQ-14 assigned to	[PCI Device]	
IRQ-15 assigned to	[PCI Device]	
F1: Help	↑↓: Select Item	-/+ : Change Value
ESC: Exit	→←: Select Menu	F5: Setup Defaults
		F10: Save and Exit
	Enter: Select Sub-menu	

IRQ-xx assigned to

When set to [PCI Device], the specific IRQ is free for use of PCI/PnP devices. When set to [Reserved], the IRQ is reserved for legacy ISA devices. Configuration options: [PCI Device] [Reserved]

PCI/VGA Palette Snoop [Disabled]

When set to [Enabled], the palette snooping feature informs the PCI devices that an ISA graphics device is installed in the system so that the latter can function correctly. Configuration options: [Disabled] [Enabled]

4.4.3 Onboard Devices Configuration

Phoenix-Award BIOS CMOS Setup Utility		
Advanced		
Onboard Device Configuration		Select Menu
▶ IPE Function Setup		Item Specific Help▶▶▶
▶ NVRAM Configuration		
▶ USB Configuration		
Onboard NV LAN	[Enabled]	
Onboard LAN Boot ROM	[Disabled]	
Onboard Marvell LAN	[Enabled]	
Onboard LAN2 Boot ROM	[Disabled]	
AC97 Audio	[Enabled]	
PCI IEEE 1394a	[Enabled]	
Silicon SATA Controller	[Enabled]	
Serial Port1 Address	[3F8/IRQ4]	
Parallel Port Address	[378/IRQ7]	
Parallel Port Mode	[ECP+EPP]	
ECP Mode Use DMA	[3]	
Game Port Address	[201]	
Midi Port Address	[Disabled]	
x Midi Port IRQ	10	
F1: Help	↑↓: Select Item	-/+ : Change Value
ESC: Exit	→←: Select Menu	F5: Setup Defaults
		F10: Save and Exit
	Enter: Select Sub-menu	

IDE Function Setup

This sub-menu contains IDE function-related items. Select an item then press <Enter> to edit.

Phoenix-Award BIOS CMOS Setup Utility	
Advanced	
Onboard Device Configuration	Select Menu
OnChip IDE Channel0	[Enabled] Item Specific Help▶▶
OnChip IDE Channel1	[Enabled]
IDE DMA transfer access	[Enabled]
Serial Port 1, 2	[Enabled]
SATA DMA transfer	[Enabled]
Serial Port 3, 4	[Enabled]
SATA2 DMA transfer	[Enabled]
IDE Prefetch Mode	[Enabled]

F1: Help ↑↓ : Select Item -/+ : Change Value F5: Setup Defaults
ESC: Exit →← : Select Menu Enter: Select Sub-menu F10: Save and Exit

OnChip IDE Channel0 [Enabled]

Allows you to enable or disable the onchip IDE channel 0 controller .
Configuration options: [Disabled] [Enabled]

OnChip IDE Channel1 [Enabled]

Allows you to enable or disable the onchip IDE channel 1 controller .
Configuration options: [Disabled] [Enabled]

IDE DMA transfer access [Enabled]

Allows you to enable or disable the IDE DMA transfer access.
Configuration options: [Disabled] [Enabled]

Serial Port 1, 2 [Enabled]

Allows you to enable or disable the SATA 1 and 2 ports.
Configuration options: [Disabled] [Enabled]

SATA DMA transfer [Enabled]

Allows you to enable or disable the SATA DMA transfer access.
Configuration options: [Disabled] [Enabled]

Serial Port 3, 4 [Enabled]

Allows you to enable or disable the SATA 3 and 4 ports.
Configuration options: [Disabled] [Enabled]

SATA2 DMA transfer [Enabled]

Allows you to enable or disable the SATA2 DMA transfer access.
Configuration options: [Disabled] [Enabled]

IDE Prefetch Mode [Enabled]

Allows you to enable or disable the IDE prefetch mode.
Configuration options: [Disabled] [Enabled]

NVRAID Configuration

This sub-menu contains NVRAID function-related items. Select an item then press <Enter> to edit.

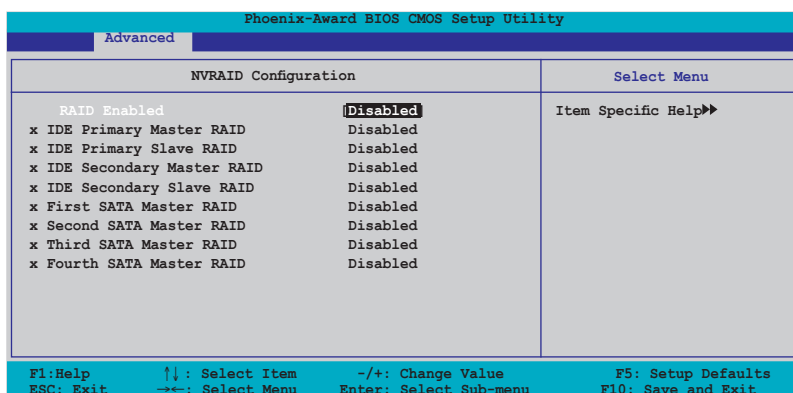

RAID Enabled [Disabled]

Enables or disables the onboard RAID controller. When Enabled, the succeeding items becomes user-configurable.
Configuration options: [Enabled] [Disabled]

IDE Primary, Secondary Master/Slave RAID [Disabled]

Enables or disables the RAID function of the primary or secondary master or slave IDE. Configuration options: [Enabled] [Disabled]

First, Second, Third, Fourth SATA Master RAID [Disabled]

Enables or disables the RAID function of the first, second, third or fourth SATA master drive. Configuration options: [Enabled] [Disabled]

USB Configuration

The items in this menu allows you to change the USB-related features. Select an item then press <Enter> to display the configuration options.

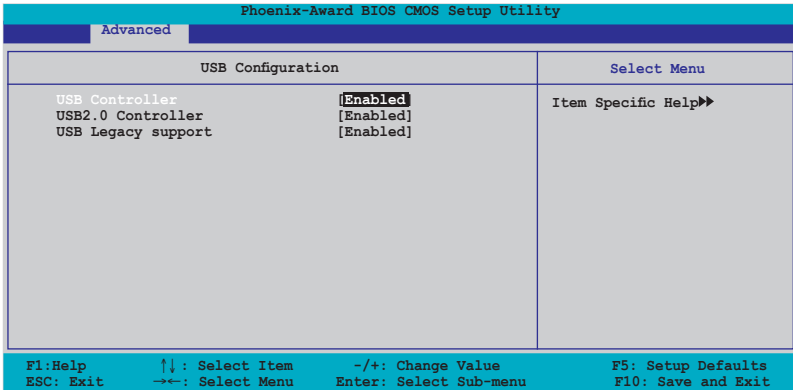

USB Controller [Enabled]

Allows you to enable or disable the onchip USB controller.
Configuration options: [Disabled] [Enabled]

USB 2.0 Controller [Enabled]

Allows you to enable or disable the USB 2.0 controller.
Configuration options: [Disabled] [Enabled]

USB Legacy Support [Enabled]

Allows you to enable or disable support for USB devices on legacy operating systems (OS). Configuration options: [Disabled] [Enabled]

Onboard NV LAN [Enabled]

Enables or disables the onboard NVIDIA® Gigabit LAN controller.
Configuration options: [Enabled] [Disabled]

OnBoard LAN Boot ROM [Disabled]

Allows you to enable or disable the onboard LAN boot ROM.
Configuration options: [Disabled] [Enabled]

Onboard Marvell LAN [Disabled]

Enables or disables the onboard Marvell® Gigabit LAN controller.
Configuration options: [Enabled] [Disabled]

OnBoard LAN2 Boot ROM [Disabled]

Allows you to enable or disable the onboard LAN 2 boot ROM. This item is user-configurable only when the PCI Giga LAN item is Enabled.

Configuration options: [Disabled] [Enabled]

AC97 Audio [Enabled]

Allows you to disable or enabled the onboard AC97 audio controller.

Configuration options: [Disabled] [Enabled]

PCI IEEE 1394a [Enabled]

Allows you to disable or enabled the onboard PCI IEEE 1394 controller.

Configuration options: [Disabled] [Enabled]

Silicon SATA Controller [Enabled]

Allows you to enable or disable the onboard Silicon Image RAID controller.

Configuration options: [Disabled] [Enabled]

Serial Port1 Address [3F8/IRQ4]

Allows you to select the Serial Port1 base address.

Configuration options: [Disabled] [3F8/IRQ4] [3E8/IRQ4] [2E8/IRQ3]

Parallel Port Address [378/IRQ7]

Allows you to select the Parallel Port base addresses.

Configuration options: [Disabled] [378/IRQ7] [278/IRQ5] [3BC/IRQ7]

Parallel Port Mode [ECP+EPP]

Allows you to select the Parallel Port mode.

Configuration options: [Normal] [Bi-directional] [EPP] [ECP]

ECP Mode Use DMA [3]

Allows selection of ECP Mode. Configuration options: [1] [3]

Game Port Address [201]

Allows you to select the Game Port address or to disable the port.

Configuration options: [Disabled] [201] [209]

Midi Port Address [Disabled]

Allows you to select the Midi Port address or to disable the port.

Configuration options: [Disabled] [330] [300]

Midi Port IRQ [10]

Allows you to set the Midi port IRQ address. Configuration options: [5] [10]

4.4.4 SLI Configuration

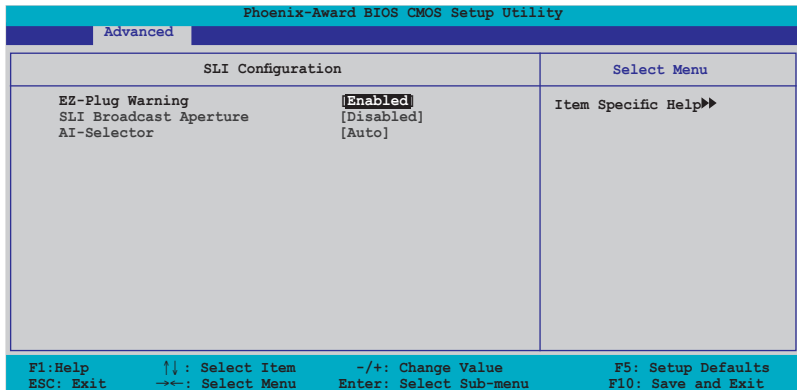

EZ-Plug Warning [Enabled]

Allows you to enable or disable the EZ-Plug warning feature.
Configuration options: [Disabled] [Enabled]

SLI Broadcast Aperture [Disabled]

Allows you to enable or disable the SLI Broadcast Aperture.
Configuration options: [Disabled] [Auto]

AI Selector [Auto]

Allows you to set the AI selector. When set to Auto, the BIOS detects the number of PCI Express graphics cards installed. Set to Single Video Card when using one PCI Express graphics card or set to Dual Video Cards when using two SLI-ready graphics cards.
Configuration options: [Auto] [Single Video Card] [Dual Video Card]



- We recommend to keep the setting of this item to [Auto].
- When not set to [Auto], make sure that the setting is the same as the ASUS AI Selector. If the BIOS setting is not the same as the AI Selector utility, the system follows the latter.
- See section “5.9 Using the ASUS AI Selector utility” on page 5-46 for details.

4.4.5 JumperFree Configuration

Phoenix-Award BIOS CMOS Setup Utility		
Advanced		
JumperFree Configuration		Select Menu
Overclock Profile	Auto	Item Specific Help▶▶
x Overclock Options	Disable	
x N.O.S. Option	Disable	
x CPU Frequency	200.00	
x PCI Express Clock	100Mhz	
x DDR Voltage	Auto	
x Chipset Voltage	+1.5V	
x HT Voltage	+1.20V	
x CPU Multiplier	Auto	
x CPU Voltage	Auto	
x PCI Clock Synchronization Mode	Auto	

F1: Help ↑↓: Select Item -/+ : Change Value F5: Setup Defaults
ESC: Exit ←→: Select Menu Enter: Select Sub-menu F10: Save and Exit

Overclock Profile [Auto]

Allows selection of CPU overclocking options to achieve desired CPU internal frequency. Select either one of the preset overclocking configuration options:

Manual	Allows you to individually set overclocking parameters.
Auto	Loads the optimal settings for the system.
Standard	Loads the standard settings for the system.
AI Overclock	Loads overclocking profiles with optimal parameters for stability when overclocking.
AI N.O.S.	The ASUS AI Non-delay Overclocking System feature intelligently determines the system load and automatically boost the performance for the most demanding tasks.



The following items are user-configurable only when the Overclock Profile item is set to [Manual].

CPU Frequency [XXX] (value is auto-detected)

Indicates the frequency sent by the clock generator to the system bus and PCI bus. The bus frequency (external frequency) multiplied by the bus multiple equals the CPU speed. The value of this item is auto-detected by BIOS. The values range from 200 to 400. Refer to the following table for the correct Front Side Bus and CPU External Frequency settings.



Selecting a very high CPU frequency may cause the system to become unstable! If this happens, revert to the default setting.

PCI Express Clock [100MHz]

Allows you to set the PCI Express clock. Key-in a decimal value between 100-200 MHz. Configuration options: [100MHz] [101MHz~[145MHz]

DDR Voltage [Auto]

Sets the operating DDR voltage. Configuration options: [Auto] [2.60V] [2.65V] [2.70V] [2.75V] [2.80V] [2.85V] [2.90V] [2.95V] [3.00V]

Chipset Voltage [+1.5V]

Sets the operating chipset voltage. Configuration options: [+1.5V] [+1.6V]

HT Voltage [+1.2V]

Sets the operating HT voltage. Configuration options: [+1.2V] [+1.25V]

CPU Multiplier [Auto]

Sets the operating CPU multiplier. The configuration options vary depending on the type of CPU installed. Configuration options: [Auto] [x4] [x4.5] [x5] [x5.5] [x6] [x6.5] [x7] [x7.5] [x7.5] [x8] [x8.5] [x9] [x9.5] [x10] [x10.5] [x11] [x11.5] [x12] [x12.5] [x13] [x13.5] [x14] [x14.5] [x15] [x15.5] [x16] [x16.5] [x17] [x17.5] [x18] [x18.5] [x19] [x19.5] [x20]

CPU Voltage [Auto]

Sets the operating CPU voltage. Configuration options: [Auto] [1.650V] [1.6375V] [1.625V] [1.6125V] [1.600V] [1.5875V] [1.575V] [1.5625V] [1.550V] [1.5375V] [1.525V] [1.5125V] [1.500V] [1.4875V] [1.475V] [1.4625V] [1.450V] [1.4375V] [1.425V] [1.4125V] [1.400V] [1.3875V] [1.375V] [1.3625V] [1.350V] [1.3375V] [1.325V] [1.3125V] [1.300V] [1.2875V] [1.275V] [1.2625V] [1.250V] [1.2375V] [1.225V] [1.2125V] [1.200V] [1.1875V] [1.175V] [1.1625V] [1.150V] [1.1375V] [1.125V] [1.1125V] [1.100V] [1.0875V] [1.075V] [1.0625V] [1.050V] [1.0375V] [1.025V] [1.0125V] [1.000V] [0.9875V] [0.975V] [0.9625V] [0.950V] [0.9375V] [0.925V] [0.9125V] [0.900V] [0.8875V] [0.875V] [0.8625V] [0.850V] [0.8375V] [0.825V] [0.8125V] [0.800V]

PCI Clock Synchronization Mode [Auto]

Sets the PCI Clock Synchronization mode. Configuration options: [Auto] [To CPU] [33.33MHz]



The following item is user-configurable only when the Overclock Profile item is set to [AI Overclock].

Overclock Options [Disable]

Allows you to set the overlocking options.

Configuration options: [Disable] [Overclock 3%] [Overclock 5%]
[Overclock 8%] [Overclock 10%]



The following item is user-configurable only when the Overclock Profile item is set to [AI N.O.S.].

N.O.S. Option [Disable]

Sets the Non-Delay Overclocking System mode.

Configuration options: [Disable] [Overclock 3%] [Overclock 5%]
[Overclock 8%] [Overclock 10%]

4.4.6 LAN Cable Status

The items in this menu displays the status of the Local Area Network (LAN) cable.

Phoenix-Award BIOS CMOS Setup Utility			
Advanced			
JumperFree Configuration			Select Menu
POST Check LAN Cable			[Disabled]
			Item Specific Help▶▶
Pair	Status	Length	Enable/Disable Speech
1-2	Open	N/A	IC Controller
3-6	Open	N/A	
4-5	Open	N/A	
7-8	Open	N/A	
1-2	Open	N/A	
3-6	Open	N/A	
4-5	Open	N/A	
7-8	Open	N/A	
F1: Help	↑↓: Select Item	-/+ : Change Value	F5: Setup Defaults
ESC: Exit	→←: Select Menu	Enter: Select Sub-menu	F10: Save and Exit

POST Check LAN cable [Disabled]

Enables or disables checking of the LAN cable during the Power-On Self-Test (POST). Configuration options: [Disabled] [Enabled]

4.4.7 PEG Link Mode

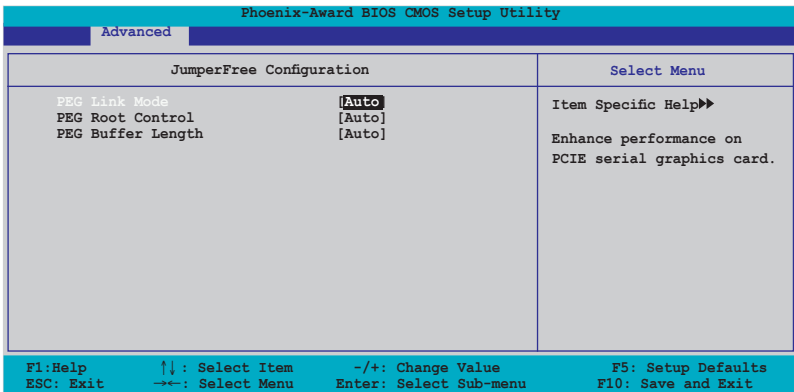

PEG Link Mode [Disabled]

Allows you to enhance the performance of your PCI Express graphics card.
Configuration options: [Auto] [Slow] [Normal] [Fast] [Faster]



Setting to [Faster] may cause your system to be unstable. If this happens, revert to [Auto].

PEG Root Control [Auto]

Allows you to enable or disable the PCI Express graphics root control.
Configuration options: [Auto] [Enabled] [Disabled]

PEG Buffer Length [Auto]

Allows you to set the PCI Express graphics buffer length. For optimum performance, set this item to Auto.
Configuration options: [Auto] [Long] [Short]

4.4.8 Speech Configuration

Phoenix-Award BIOS CMOS Setup Utility		
Advanced		
JumperFree Configuration		Select Menu
Speech IC Reporter	Enable	Item Specific Help▶▶ Enable/Disable Speech IC Controller
Report IDE Error	[Disabled]	
Report System Booting	[Disabled]	

Speech IC Reporter [Enabled]

Allows you to enable or disable the ASUS Speech POST Reporter™ feature. Configuration options: [Disabled] [Enabled]



The following items appear only when Speech IC Reporter is set to Enabled.

Report IDE Error [Disabled]

Enables or disables the report feature in the event of an IDE error. Configuration options: [Disabled] [Enabled]

Report System Booting [Disabled]

Enables or disables the report after booting the system. Configuration options: [Disabled] [Enabled]

4.4.9 Instant Music

Phoenix-Award BIOS CMOS Setup Utility		
Advanced		
JumperFree Configuration		Select Menu
Instant Music	Disabled	Item Specific Help▶▶
x Instant Music CD-ROM Drive	Primary Master	

Instant Music [Disabled]

Allows you to enable or disable the ASUS Instant Music feature. Configuration options: [Disabled] [Enabled]



Enabling Instant Music automatically disables the PS/2 keyboard power up feature.

Instant Music CD-ROM Drive [Primary Master]

Allows you to select the CD-ROM drive that you wish to use for the Instant Music CD playback. Configuration options: [Primary Master] [Primary Slave] [Secondary Master] [Secondary Slave]

4.5 Power menu

The Power menu items allow you to change the settings for the Advanced Configuration and Power Interface (ACPI) and the Advanced Power Management (APM). Select an item then press <Enter> to display the configuration options.

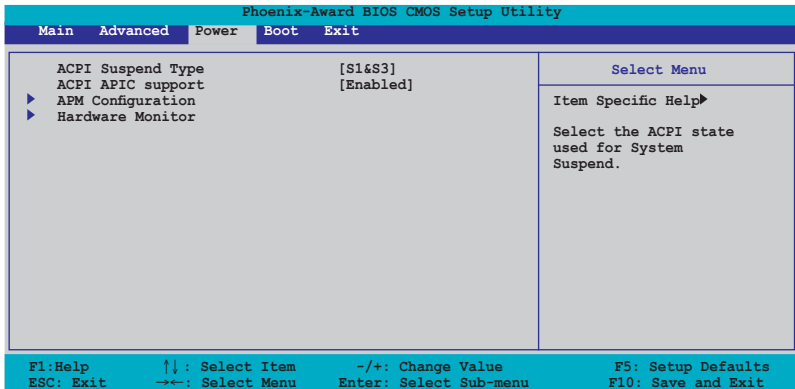

4.5.1 ACPI Suspend Type [S1&S3]

Allows you to select the Advanced Configuration and Power Interface (ACPI) state to be used for system suspend.

Configuration options: [S1 (POS)] [S3(STR)] [S1&S3]

4.5.2 ACPI APIC Support [Enabled]

Allows you to enable or disable the Advanced Configuration and Power Interface (ACPI) support in the Application-Specific Integrated Circuit (ASIC). When set to Enabled, the ACPI APIC table pointer is included in the RSDT pointer list. Configuration options: [Disabled] [Enabled]

4.5.3 APM Configuration

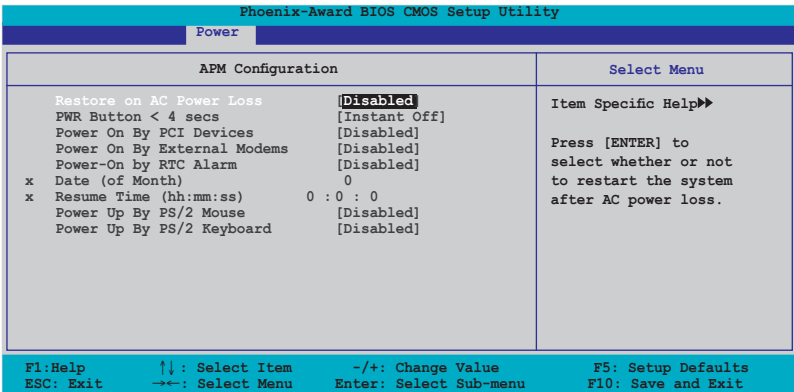

Restore on AC Power Loss [Disabled]

Allows you to enable or disable the Restore on AC Power Loss function. Configuration options: [Disabled] [Enabled]

PWR Button < 4 secs [Instant-Off]

Allows you to set the event after the power button is pressed for more than 4 seconds. Configuration options: [Suspend] [Instant-Off]

Power On By PCI Devices [Disabled]

When set to [Enabled], this parameter allows you to turn on the system through a PCI LAN or modem card. This feature requires an ATX power supply that provides at least 1A on the +5VSB lead. Configuration options: [Disabled] [Enabled]

Power On By External Modems [Disabled]

This allows either settings of [Enabled] or [Disabled] for powering up the computer when the external modem receives a call while the computer is in Soft-off mode. Configuration options: [Disabled] [Enabled]



The computer cannot receive or transmit data until the computer and applications are fully running. Thus, connection cannot be made on the first try. Turning an external modem off and then back on while the computer is off causes an initialization string that turns the system power on.

Power On By RTC Alarm [Disabled]

Allows you to enable or disable RTC to generate a wake event. When this item is set to Enabled, the items Date of Month Alarm and Time (hh:mm:ss) Alarm items become user-configurable with set values.

Configuration options: [Disabled] [Enabled]

Day of Month Alarm [Disabled]

To set the date of alarm, highlight this item and press <Enter> to display the Day of Month Alarm pop-up menu. Key-in a value within the specified range then press <Enter>. Configuration options: [Min=0] [Max=31]

Time (hh:mm:ss) Alarm [Disabled]

To set the time of alarm:

1. Highlight this item and press <Enter> to display a pop-up menu for the hour field.
2. Key-in a value (Min=0, Max=23), then press <Enter>.
3. Press <TAB> to move to the minutes field then press <Enter>.
4. Key-in a minute value (Min=0, Max=59), then press <Enter>.
5. Press <TAB> to move to the seconds field then press <Enter>.
6. Key-in a value (Min=0, Max=59), then press <Enter>.

Power Up By PS/2 Mouse [Disabled]

When set to [Enabled], this parameter allows you to use the PS/2 mouse to turn on the system. This feature requires an ATX power supply that provides at least 1A on the +5VSB lead.

Configuration options: [Disabled] [Enabled]

Power On By PS/2 Keyboard [Disabled]

Allows you to disable the Power On by PS/2 keyboard function or set specific keys on the PS/2 keyboard to turn on the system. This feature requires an ATX power supply that provides at least 1A on the +5VSB lead.

Configuration options: [Disabled] [Space Bar] [Ctrl-ESC] [Power Key]

4.5.4 Hardware Monitor

The items in this sub-menu displays the hardware monitor values automatically detected by the BIOS. It also allows you to change CPU Q-Fan feature-related parameters. Select an item then press <Enter> to display the configuration options.

Phoenix-Award BIOS CMOS Setup Utility		
Power		
Hardware Monitor		Select Menu
Q-Fan Controller	[Disabled]	Item Specific Help▶▶
Vcore Voltage	1.50V	Press [Enter] to enable or disable
3.3V Voltage	3.31V	
5V Voltage	4.94V	
12V Voltage	11.26V	
CPU Temperature	48°C	
M/B Temperature	38°C	
CPU FAN Speed	4962 RPM	
CHA1 FAN Speed	0 RPM	
CHIP FAN Speed	5443 RPM	
x CPU Target Temperature	20°C	
CPU Fan Speed warning	[1600 RPM]	
CPU Fan Speed warning	[1200 RPM]	
CHIP Fan Speed warning	[Enabled]	

F1: Help	↑↓: Select Item	-/+ : Change Value	F5: Setup Defaults
ESC: Exit	→←: Select Menu	Enter: Select Sub-menu	F10: Save and Exit

Q-Fan Controller [Disabled]

Allows you to enable or disable the Q-Fan controller.
Configuration options: [Disabled] [Enabled]

VCORE Voltage, +12V Voltage, 3.3V Voltage, 5VCC Voltage

The onboard hardware monitor automatically detects the voltage output through the onboard voltage regulators. These items are not user-configurable.

CPU Temperature, M/B Temperature

The onboard hardware monitor automatically detects and displays the motherboard and CPU temperatures. These items are not user-configurable.

CPU Fan Speed CHA1 Fan Speed CHIP Fan Speed

The onboard hardware monitor automatically detects and displays the Chassis, CPU, and Chip fan speeds in rotations per minute (RPM). If the fan is not connected to the motherboard, the field shows 0. These items are not user-configurable.

CPU Target Temperature

Allows you to set the temperature threshold before the CPU fan stops.

Configuration options: [51°C] [54°C] [57°C] [60°C] [63°C] [66°C] [69°C] [72°C] [75°C] [78°C] [81°C]

CPU Fan Speed warning [1200 RPM]

Allows you to set the CPU fan warning speed.

Configuration options: [Disabled] [800 RPM] [1200 RPM] [1600 RPM]

CHA1 Fan Speed warning [Disabled]

Allows you to set the chassis fan warning speed.

Configuration options: [Disabled] [500 RPM] [800 RPM] [1200 RPM]

CHIP Fan Speed warning [Enabled]

Enables or disables the chip fan speed warning feature.

Configuration options: [Disabled] [Enabled]

4.6 Boot menu

The Boot menu items allow you to change the system boot options. Select an item then press <Enter> to display the sub-menu.

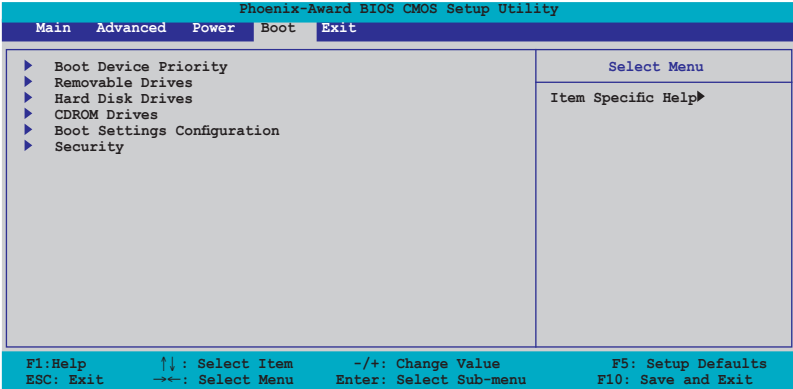

4.6.1 Boot Device Priority

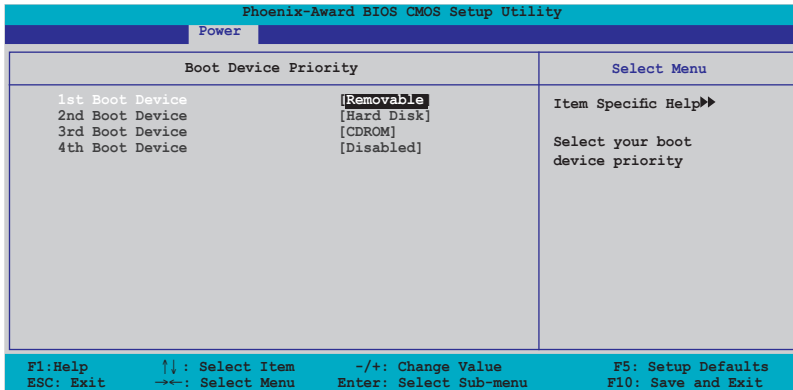

1st ~ xxth Boot Device [Removable]

These items specify the boot device priority sequence from the available devices. The number of device items that appears on the screen depends on the number of devices installed in the system.

Configuration options: [Removable] [Hard Disk] [CDROM] [Legacy LAN] [Disabled]

4.6.2 Removable Drives

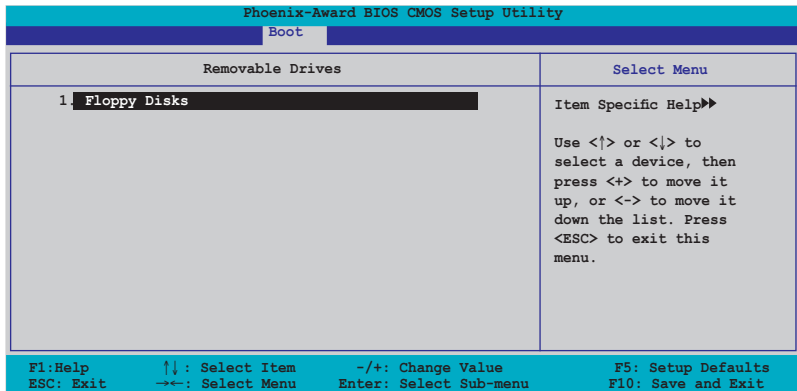

1. Floppy Disks

Allows you to assign a removable drive attached to the system.

4.6.3 Hard Disk Drives

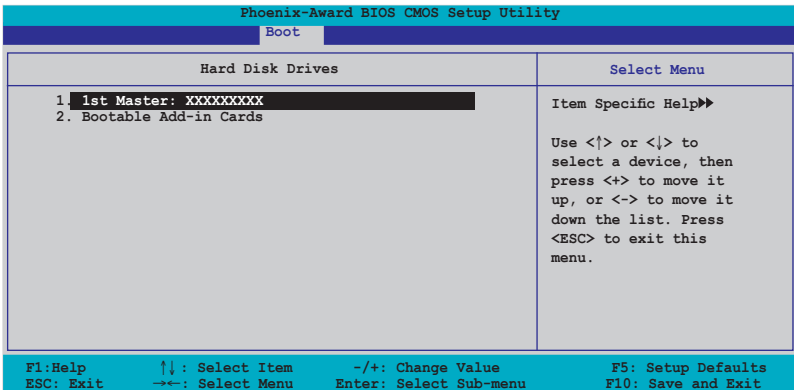

1. 1st Master: XXXXXXXXX

Allows you to assign hard disk drives attached to the system.

2. Bootable Add-in Cards

Allows you to select an add-in disk drive attached to the system.

4.6.4 CDROM Drives

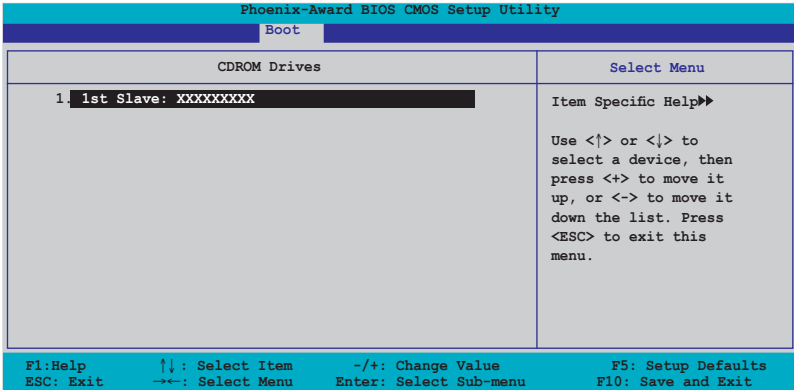

1. 1st Slave: XXXXXXXXXX

Allows you to assign optical drives attached to the system.

4.6.5 Boot Settings Configuration

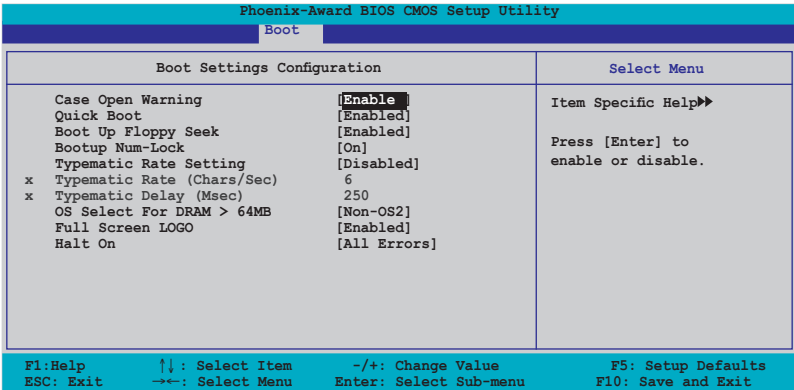

Case Open Warning [Enabled]

Enables or disables the chassis open status feature. Setting to Enabled, clears the chassis open status. Refer to section “2.7 Internal connectors” for setting details. Configuration options: [Disabled] [Enabled]

Quick Boot [Enabled]

Allows you to enable or disable the system quick boot feature. When Enabled, the system skips certain tests while booting. Configuration options: [Disabled] [Enabled]

Boot Up Floppy Seek [Enabled]

Enable this item to check for a boot floppy disk during POST.
Configuration options: [Disabled] [Enabled]

Bootup Num-Lock [On]

Allows you to select the power-on state for the NumLock.
Configuration options: [Off] [On]

Typematic Rate Setting [Disabled]

Allows you to set the keystroke rate. Enable this item to configure the Typematic Rate (Chars/Sec) and the Typematic Delay (Msec).
Configuration options: [Disabled] [Enabled]



The items Typematic Rate (Chars/Sec) and Typematic Delay (Msec) becomes user-configurable only when the item Typematic Rate Setting is enabled.

Typematic Rate (Chars/Sec) [6]

Allows you to select the rate at which a character repeats when you hold a key. Configuration options: [6] [8] [10] [12] [15] [20] [24] [30]

Typematic Delay (Msec) [250]

Allows you to set the delay before keystrokes begin to repeat.
Configuration options: [250] [500] [750] [1000]

OS Select for DRAM > 64MB [Non-OS2]

Set this item to OS2 only when you are running on an OS/2 operating system with an installed RAM of greater than 64 KB.
Configuration options: [Non-OS2] [OS2]

Full Screen LOGO [Enabled]

Allows you to enable or disable the full screen logo display feature.
Configuration options: [Disabled] [Enabled]



-
- Make sure that the above item is set to [Enabled] if you want to use the ASUS MyLogo2™ feature.
 - See section “5.4.1 ASUS MyLogo2™” for details.
-

Halt On [All Errors]

Allows you to error report type.
Configuration options: [All Errors] [No Errors] [All, But Keyboard]
[All, But Diskette] [All, But Disk/Key]

4.6.6 Security

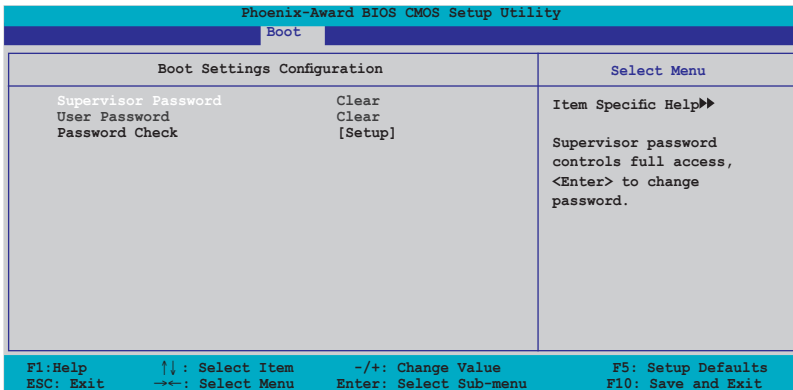

Supervisor Password User Password

These fields allow you to set passwords:

To set a password:

1. Select an item then press <Enter>.
2. Type in a password using a combination of a maximum of eight (8) alpha-numeric characters, then press <Enter>.
3. When prompted, confirm the password by typing the exact characters again, then press <Enter>. The password field setting is changed to Set.

To clear the password:

1. Select the password field and press <Enter> twice. The following message appears:



2. Press any key to continue. The password field setting is changed to Clear.

A note about passwords

The Supervisor password is required to enter the BIOS Setup program preventing unauthorized access. The User password is required to boot the system preventing unauthorized use.

Forgot your password?

If you forget your password, you can clear it by erasing the CMOS Real Time Clock (RTC) RAM. The RAM data containing the password information is powered by the onboard button cell battery. If you need to erase the CMOS RAM, refer to section “2.6 Jumpers” for instructions.

Password Check

This field requires you to enter the password before entering the BIOS setup or the system. Select [Setup] to require the password before entering the BIOS Setup. Select [System] to require the password before entering the system. Configuration options: [Setup] [System]

4.7 Exit menu

The Exit menu items allow you to load the optimal or failsafe default values for the BIOS items, and save or discard your changes to the BIOS items.

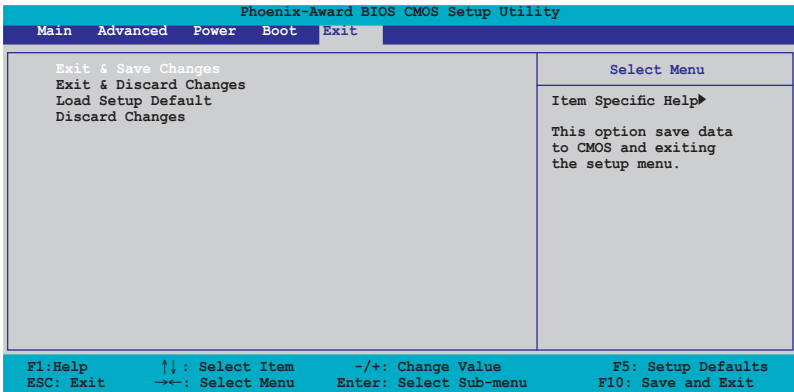

Pressing <Esc> does not immediately exit this menu. Select one of the options from this menu or <F10> from the legend bar to exit.

Exit & Save Changes

Once you are finished making your selections, choose this option from the Exit menu to ensure the values you selected are saved to the CMOS RAM. An onboard backup battery sustains the CMOS RAM so it stays on even when the PC is turned off. When you select this option, a confirmation window appears. Select **Yes** to save changes and exit.



If you attempt to exit the Setup program without saving your changes, the program prompts you with a message asking if you want to save your changes before exiting. Press <Enter> to save the changes while exiting.

Exit & Discard Changes

Select this option only if you do not want to save the changes that you made to the Setup program. If you made changes to fields other than System Date, System Time, and Password, the BIOS asks for a confirmation before exiting.

Load Setup Defaults

This option allows you to load the default values for each of the parameters on the Setup menus. When you select this option or if you press <F5>, a confirmation window appears. Select **Yes** to load default values. Select **Exit & Save Changes** or make other changes before saving the values to the non-volatile RAM.

Discard Changes

This option allows you to discard the selections you made and restore the previously saved values. After selecting this option, a confirmation appears. Select **Yes** to discard any changes and load the previously saved values.

This chapter describes the contents of the support CD that comes with the motherboard package.

5 Software support

Chapter summary

5.1	Installing an operating system.....	5-1
5.2	Support CD information	5-1
5.4	Software information	5-9
5.5	RAID configurations	5-21
5.6	Creating a RAID driver disk	5-40
5.7	Cool 'n' Quiet!™ Technology	5-41
5.8	Using the NVIDIA® nTune™ utility	5-43
5.9	Using the ASUS AI Selector utility	5-46

5.1 Installing an operating system

This motherboard supports Windows® 2000/XP operating systems (OS). Always install the latest OS version and corresponding updates to maximize the features of your hardware.



- Motherboard settings and hardware options vary. Use the setup procedures presented in this chapter for reference only. Refer to your OS documentation for detailed information.
- Make sure that you install Windows® 2000 Service Pack 4 or the Windows® XP Service Pack 2 or later versions before installing the drivers for better compatibility and system stability.

5.2 Support CD information

The support CD that came with the motherboard package contains the drivers, software applications, and utilities that you can install to avail all motherboard features.



The contents of the support CD are subject to change at any time without notice. Visit the ASUS website (www.asus.com) for updates.

5.2.1 Running the support CD

Place the support CD to the optical drive. The CD automatically displays the Drivers menu if Autorun is enabled in your computer.

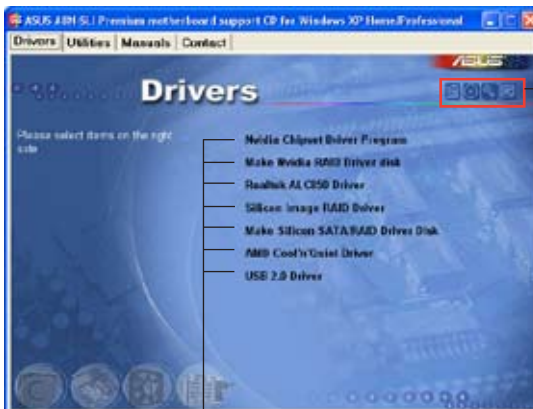

Click an icon to display support CD/motherboard information

Click an item to install



If Autorun is NOT enabled in your computer, browse the contents of the support CD to locate the file ASSETUP.EXE from the BIN folder. Double-click the ASSETUP.EXE to run the CD.

5.2.2 Drivers menu

The drivers menu shows the available device drivers if the system detects installed devices. Install the necessary drivers to activate the devices.



Nvidia Chipset Driver Program

Installs the NVIDIA® Chipset drivers for the NVIDIA® nForce™ 4 SLI chipset.

Make NVIDIA RAID Driver Disk

Creates the NVIDIA® driver disk for Serial ATA and RAID features.

Marvell Yukon Gigabit Ethernet Driver

Installs the Marvell® Yukon Gigabit Ethernet driver.

Realtek ALC850 Driver

Installs the Realtek® ALC850 audio controller and application.

Silicon Image RAID Driver

Displays the README file of the Silicon Image SATA Link™ Sil 3114 driver driver installation.

Make Silicon SATA RAID Driver Disk

Creates the Silicon Image SATA Link™ Sil 3114 driver disk for Serial ATA RAID.

USB 2.0 Driver

Installs the Universal Serial Bus 2.0 (USB 2.0) driver.



The screen display and drivers option may not be the same for different operating system versions.

5.2.3 Utilities menu

The Utilities menu shows the applications and other software that the motherboard supports.



NVIDIA Chipset nTune Utility

Installs the NVIDIA® nTune™ utility that allows easy and safe system tuning for optimum performance.

ASUS PC Probe

This smart utility monitors the fan speed, CPU temperature, and system voltages, and alerts you of any detected problems. This utility helps you keep your computer in healthy operating condition.

ASUS Update

Allows you to download the latest version of the BIOS from the ASUS website.



Before using the ASUS Update, make sure that you have an Internet connection so you can connect to the ASUS website.

ASUS AI Booster

The ASUS AI Booster application allows you to overclock the CPU speed in a Windows® environment.

ASUS AI Selector

The ASUS AI Selector utility allows you to set the video card mode of your system.

Microsoft DirectX

Installs the Microsoft® DirectX 9.0 driver. The Microsoft DirectX® 9.0 is a multimedia technology that enhances computer graphics and sound. DirectX® improves the multimedia features of your computer so you can enjoy watching TV and movies, capturing videos, or playing games in your computer. Visit the Microsoft website (www.microsoft.com) for updates.

Anti-virus Utility

The anti-virus application detects and protects your computer from viruses that destroys data.

ADOBE Acrobat Reader

Installs the Adobe® Acrobat® Reader that allows you to open, view, and print documents in Portable Document Format (PDF).

Winbond Voice Editor

This program is for recording and customizing wave files for the ASUS POST Reporter™. Use this program to change the default vocal POST messages. See section “3.2 Vocal POST Messages” for a list of the default messages.

ASUS Screen Saver

Bring life to your computer screen by installing the ASUS screen saver.

ASUS AMD Cool ‘n’ Quiet Software

Installs the AMD® Cool ‘n’ Quiet! software.

5.2.4 Manuals menu

The Manuals menu contains a list of supplementary user manuals. Click an item to open the folder of the user manual.



- Most user manual files are in Portable Document Format (PDF). Install the Adobe® Acrobat® Reader from the Utilities menu before opening a user manual file.
- Some user manuals listed in this menu may not be applicable for this motherboard model.

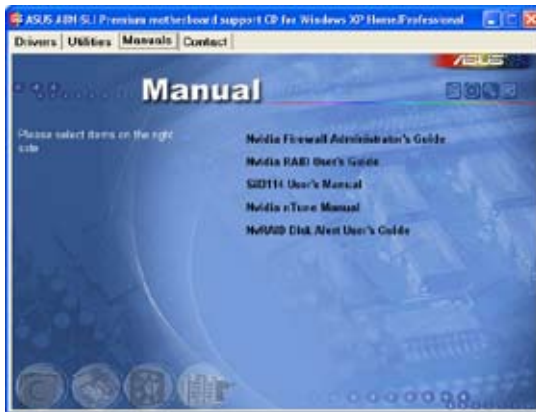

NVIDIA Firewall Administrator's Guide

Allows you to open the NVIDIA® ForceWare Networking and Firewall Administrator's Guide.

NVIDIA RAID User's Guide

Allows you to open the NVIDIA® RAID User's Guide.

SiI3114 User's Manual

Allows you to open the Silicon Image SATAraid™ Serial ATA RAID Management Software user's manual.

NVIDIA nTune Manual

Allows you to open the NVIDIA® nTune™ user's manual.

NVRAID Disk Alert User's Guide

Allows you to open the NVIDIA® RAID Disk Alert user's manual.

5.2.5 ASUS Contact information

Click the Contact tab to display the ASUS contact information. You can also find this information on the inside front cover of this user guide.



5.2.6 Other information

The icons on the top right corner of the screen give additional information on the motherboard and the contents of the support CD. Click an icon to display the specified information.

Motherboard Info

Displays the general specifications of the motherboard.



Browse this CD

Displays the support CD contents in graphical format.

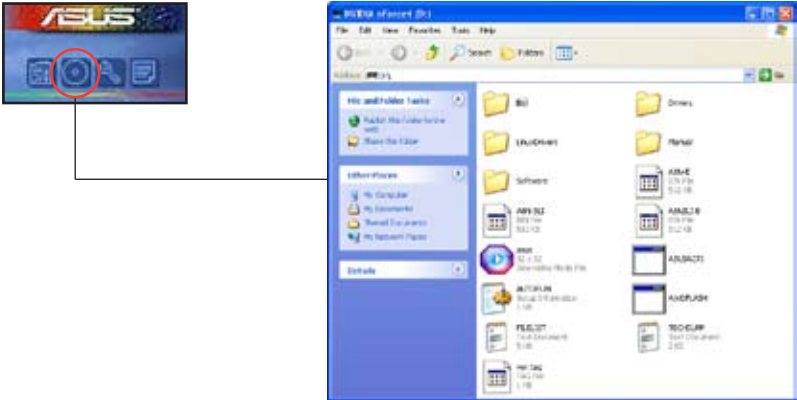

Technical support Form

Displays the ASUS Technical Support Request Form that you have to fill out when requesting technical support.

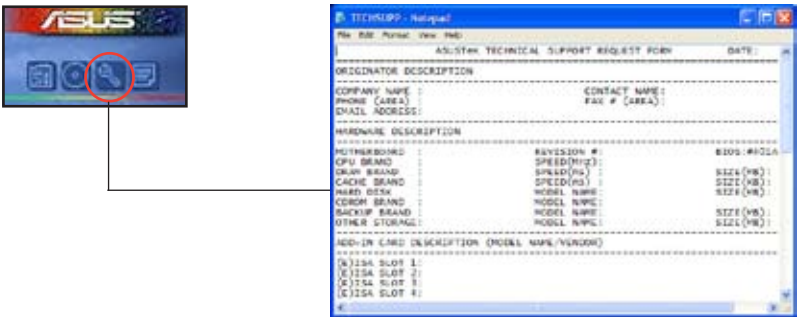

- When the logo images appear on the right window pane, select an image to enlarge by clicking on it.

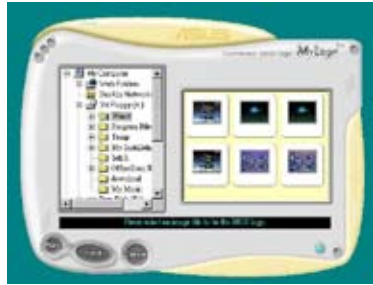

- Adjust the boot image to your desired size by selecting a value on the Ratio box.



- When the screen returns to the ASUS Update utility, flash the original BIOS to load the new boot logo.
- After flashing the BIOS, restart the computer to display the new boot logo during POST.

5.4.2 AI NET 2

The Marvell® Virtual Cable Tester™ (VCT) is a cable diagnostic utility that reports LAN cable faults and shorts using the Time Domain Reflectometry (TDR) technology. The VCT detects and reports open and shorted cables, impedance mismatches, pair swaps, pair polarity problems, and pair skew problems of up to 100 meters at one meter accuracy.

The VCT feature reduces networking and support costs through a highly manageable and controlled network system. This utility can be incorporated in the network systems software for ideal field support as well as development diagnostics.

Using the Virtual Cable Tester™

To use the the Marvell® Virtual Cable Tester™ utility:

1. Launch the VCT utility from the Windows® desktop by clicking Start > All Programs > Marvell > Virtual Cable Tester.
2. Click Virtual Cable Tester from the menu to display the screen below.

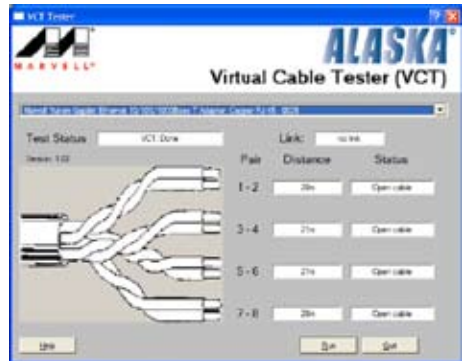

3. Click the Run button to perform a cable test.



- The VCT only runs on systems with Windows® XP or Windows® 2000 operating systems.
- The Run button on the Virtual Cable Tester™ main window is disabled if no problem is detected on the LAN cable(s) connected to the LAN port(s).
- If you want the system to check the LAN cable before entering the OS, enable the POST Check LAN cable item in the BIOS. See section “4.4.6 LAN Cable Status” for details.

5.4.3 Audio configurations

The Realtek® ALC850 AC '97 audio CODEC provides 8-channel audio capability to deliver the ultimate audio experience on your PC. The software provides Jack-Sensing function (Line-In, Line-Out, Mic-In), S/PDIF out support and interrupt capability. The ALC850 also includes the Realtek® proprietary UAJ® (Universal Audio Jack) technology for three ports (Line-In, Line-Out and Mic-In), eliminating cable connection errors and giving users plug and play convenience.

Follow the installation wizard to install the Realtek ALC850 Audio Driver and Application from the support CD that came with the motherboard package.

If the Realtek audio software is correctly installed, you will find the SoundEffect icon on the taskbar.

From the taskbar, double-click on the SoundEffect icon to display the Realtek Audio Control Panel.



Realtek SoundEffect icon



The Jack-sensing and UAJ® technology features are supported on the Line-In, Line-Out, and Mic jacks only.

Sound Effect options

The Realtek® ALC850 Audio CODEC allows you to set your listening environment, adjust the equalizer, set the karaoke, or select pre-programmed equalizer settings for your listening pleasure.

To set the sound effect options:

1. From the Realtek Audio Control Panel, click the Sound Effect button.
2. Click the shortcut buttons to change the acoustic environment, adjust the equalizer, or set the karaoke to your desired settings.
3. The audio settings take effect immediately after you click on the buttons.
4. Click the Exit (X) button on the upper-right hand corner of the window to exit.



S/PDIF option

The Sony/Philips Digital Interface (S/PDIF) options allows you to change your S/PDIF output settings.

To set the S/PDIF options:

1. From the Realtek Audio Control Panel, click the SPDIF button.
2. Click the option buttons to change your S/PDIF out settings.
3. Click the Exit (X) button on the upper-right hand corner of the window to exit.



Speaker Configuration

This option allows you to set your speaker configuration.

To set the speaker configuration:

1. From the Realtek Audio Control Panel, click the Speaker Configuration button.
2. Select from the combo list box your current speaker setup, then click Auto Test to test your settings.
3. Click the UAJ Automatic button to enable or disable the Universal Audio Jack(UAJ®) technology feature.
4. Click the Exit (X) button on the upper-right hand corner of the window to exit.



AI Audio feature

The AI Audio feature works through the connector sensing option that allows you to check if your audio devices are connected properly.

To start the connector sensing:

1. From the Realtek Audio Control Panel, click the Connector Sensing button.
2. Click the Bracket button to display connected audio devices.
3. Click the Option button to change sensing options.
4. Click the Start button to start connection sensing. A progress bar displays current connector sensing status.



Make sure to exit all audio applications before starting this function.



5. When finished, the utility prompts the Realtek® EZ-connection dialog box showing your current audio connections. The text at the bottom of the box explains your audio connection status. An *X mark* denotes an incorrect connection.



6. If there are detected problems, make sure that your audio cables are connected to the proper audio jack and repeat connector sensing.
7. Click the X button to exit EZ-connection dialog box.
8. Click the Exit (X) button on the upper-right hand corner of the window to exit audio control panel.

HRTF Demo

This option shows a demo of the Head-Related Transfer Functions (HRTF).

To start the HRTF demo:

1. From the Realtek Audio Control Panel, click the HRTF Demo button.
2. Click the option buttons to change the sound, moving path or EAX settings.
3. Click the Play button to start or the Stop button to stop.
4. Click the Exit (X) button on the upper-right hand corner of the window to exit.



General settings

This option shows the audio settings and allows you to change the language setting or toggle the SoundEffect icon display on the Windows taskbar.

To display the general settings:

1. From the Realtek Audio Control Panel, click the General button.
2. Click the option button to enable or disable the icon display on the Windows taskbar.
3. Click the Language combo list box to change language display.
4. Click the Exit (X) button on the upper-right hand corner of the window to exit.



Rear panel audio ports function variation

The functions of the Line Out (lime), Line In (blue), Mic (pink), Rear Speaker Out (gray), Side Speaker Out (black), and Center/Subwoofer (yellow orange) ports on the rear panel change when you select the 4-channel, 6-channel or 8-channel audio configuration as shown in the following table. See the 8, 6, 4 or 2-channel speaker configuration on page 2-20.

5.4.4 Using the NVIDIA® Firewall™

The motherboard supports the NVIDIA® Firewall™ (NVFirewall™) application that protects your computer from intruders. The NVFirewall™ is classified as a personal firewall or desktop firewall that works at the device level to protect your system from malicious computer code by controlling the connections to and from your computer and alerting you for attempted intrusions. The following sections describe how to use the NVIDIA® Firewall™.

Launching the NVFirewall™ summary

After you install the NVFirewall™ application from the motherboard support CD, it is automatically activated with a Medium security profile. The setup summary of NVFirewall™ is displayed in the summary menu.

To launch the NVFirewall™ summary menu:

1. Click the NVIDIA® Firewall™ icon from the Windows® taskbar.



NVIDIA® Firewall™ icon

2. Double-click the icon to display the NVFirewall™ Summary menu.

Click to select firewall profile

Click to view profile details

Click to view the firewall log

Click to view the firewall stats



Setting security profiles

The NVFirewall™ application allows several security profiles to match your system security needs. The following describes the NVFirewall™ security profiles:

- Low - allows safe incoming connections and deny those that are known to be dangerous connections. This profile also enables some anti-hacking features.
- Medium - blocks most incoming connections. Incoming connections to some ports must be set to allow file transfers using some online messaging applications. This profile also enables some anti-hacking features.
- High - allows the least traffic through. Only outbound connections are allowed. This profile also includes the “stealth mode” feature that makes your system invisible to intruders. This also enables some anti-hacking features.
- Lockdown - blocks all incoming and outgoing connections.
- Anti-hacking only - this profile enables all anti-hacking features but disables the firewall. This security profile is useful if you want to use a third-party firewall application.
- Custom 1, 2, 3 - these are reserved for customized profiles.
- Off - deactivates the firewall.

To set a security profile:

1. From the NVFirewall™ summary menu, click the Current Firewall Profile combo list box then select a security profile.

The following confirmation box appears.

2. Click Change Profile to apply settings or Don't Change Profile to return to previous menu.



Turning the NVFirewall™ off



Take caution when using this option, your computer becomes vulnerable to viruses, hackers or intruders after you turn off the firewall.

To turn off the NVFirewall™:

1. From the NVIDIA Firewall™ summary menu, click the Current Firewall Profile combo list box then select Off.
The following confirmation box appears.



2. Click Turn Firewall OFF.



5.5 RAID configurations

The motherboard comes with the Silicon Image Sil3114 and the NVIDIA® SLI Southbridge RAID controllers that allow you to configure IDE and Serial ATA hard disk drives as RAID sets. The motherboard supports the following RAID configurations.

RAID 0 (*Data striping*) optimizes two identical hard disk drives to read and write data in parallel, interleaved stacks. Two hard disks perform the same work as a single drive but at a sustained data transfer rate, double that of a single disk alone, thus improving data access and storage. Use of two new identical hard disk drives is required for this setup.

RAID 1 (*Data mirroring*) copies and maintains an identical image of data from one drive to a second drive. If one drive fails, the disk array management software directs all applications to the surviving drive as it contains a complete copy of the data in the other drive. This RAID configuration provides data protection and increases fault tolerance to the entire system. Use two new drives or use an existing drive and a new drive for this setup. The new drive must be of the same size or larger than the existing drive.

RAID 0+1 is *data striping* and *data mirroring* combined without parity (redundancy data) having to be calculated and written. With the RAID 0+1 configuration you get all the benefits of both RAID 0 and RAID 1 configurations. Use four new hard disk drives or use an existing drive and three new drives for this setup.

RAID 5 stripes both data and parity information across three or more hard disk drives. Among the advantages of RAID 5 configuration include better HDD performance, fault tolerance, and higher storage capacity. The RAID 5 configuration is best suited for transaction processing, relational database applications, enterprise resource planning, and other business systems. Use a minimum of three identical hard disk drives for this setup.

RAID 1+0 is a striped configuration with each stripe a RAID 1 array of drives. It combines the features of both RAID 1 and RAID 0. Fault tolerance is provided through *mirroring* while adding performance through *striping*. This offers higher performance than a RAID 1 configuration but at a much higher cost. A minimum of four hard disk drives is required for this setup.

JBOD (*Spanning*) stands for Just a Bunch of Disks and refers to hard disk drives that are not yet configured as a RAID set. This configuration stores the same data redundantly on multiple disks that appear as a single disk on the operating system. Spanning does not deliver any advantage over using separate disks independently and does not provide fault tolerance or other RAID performance benefits.



If you want to boot the system from a hard disk drive included in a RAID set, copy first the RAID driver from the support CD to a floppy disk before you install an operating system to a selected hard disk drive. Refer to section “5.6 Creating a RAID driver disk” for details.

5.5.1 Installing hard disks

The motherboard supports Ultra DMA /133/100/66 and Serial ATA hard disk drives. For optimal performance, install identical drives of the same model and capacity when creating a disk array.

Installing Parallel ATA hard disks

To install IDE hard disks for a RAID configuration:

1. Set the jumpers of each hard disk as Master/Master or Slave/Slave.
2. Install the hard disks into the drive bays.
3. Connect the HDD signal cables.
4. Connect a 4-pin power cable to the power connector on each drive.

Installing Serial ATA (SATA) hard disks

To install the SATA hard disks for a RAID configuration:

1. Install the SATA hard disks into the drive bays.
2. Connect the SATA signal cables.
3. Connect a SATA power cable to the power connector on each drive.



Refer to the RAID controllers user manual in the motherboard support CD for detailed information on RAID configurations. See section “5.2.4 Manuals menu”.

5.5.2 NVIDIA® RAID configurations

The motherboard includes a high performance IDE RAID controller integrated in the NVIDIA® SLI southbridge chipset. It supports RAID 0, RAID 1, RAID 0+1, and JBOD with four independent Serial ATA channels.

Setting the BIOS RAID items

After installing the hard disk drives, make sure to set the necessary RAID items in the BIOS before setting your RAID configuration.

To set the BIOS RAID items:

1. Boot the system and press during the Power-On Self-Test (POST) to enter the BIOS Setup Utility.
2. From the **Advanced > Onboard Devices Configuration > NVRAID Configuration** menu item in the BIOS set the RAID Enabled item to Enabled. The succeeding items become user-configurable.
3. Select and enable the IDE or SATA drive(s) that you want to configure as RAID. See section “4.4.3 Onboard Devices Configuration” for details.
4. Save your changes and Exit Setup.



For detailed descriptions on the NVIDIA® RAID configuration, refer to the “NVIDIA® RAID User’s Manual” found in your motherboard support CD.

Entering the NVIDIA® RAID utility

To enter the NVIDIA® RAID utility:

1. Boot up your computer.
2. During POST, press <F10> to display the main menu of the utility.



The RAID BIOS setup screens shown in this section are for reference only, and may not exactly match the items on your screen.

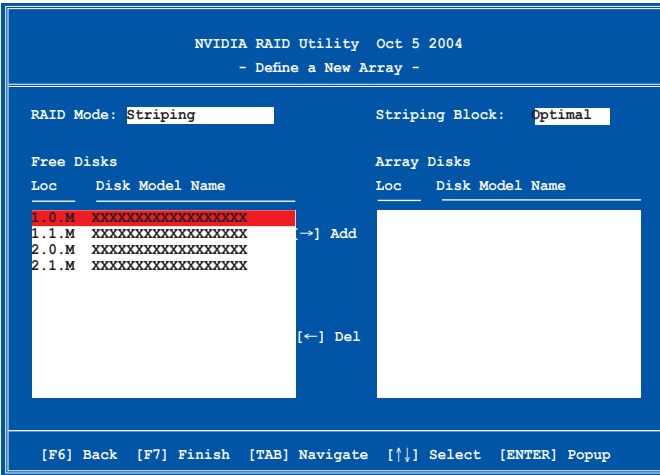

At the bottom of the screen are the navigation keys. These keys allow you to move through and select menu options.

Creating a RAID Volume

To create a RAID volume:

1. From the NVIDIA® RAID utility Define a New Array menu, select **RAID Mode** then press <Enter>. The following submenu appears.

Use the up or down arrow keys to select a RAID mode then press <Enter>.

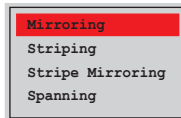

2. Press <TAB> select the Striping Block then press <Enter>. The following submenu appears:

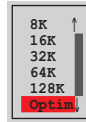

If you selected Striping or Stripe Mirroring, use the up or down arrow keys to select the stripe size for your RAID 0 array then press <Enter>. The available values range from 8 KB to 128 KB. The default selection is 128 KB. The strip value should be chosen based on the planned drive usage.

- 8 /16 KB - low disk usage
- 64 KB - typical disk usage
- 128 KB - performance disk usage



TIP: For server systems, we recommend using a lower array block size. For multimedia computer systems used mainly for audio and video editing, we recommend a higher array block size for optimum performance.

3. Press <TAB> to select the Free Disks area. Use the left or right arrow keys to assign the array disks.
4. Press <F7> to create RAID set. The following message box appears.

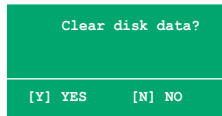

5. Press <Y> to clear the selected disks or <N> to proceed without clearing the disks. The following screen appears.



Take caution in using this option. All data on the RAID drives will be lost!

```

NVIDIA RAID Utility  Oct 5 2004
- Array List -

  Boot   Id   Status   Vendor   Array Model Name
  ----   -   -       -       -
  No     4   Healthy  NVIDIA  MIRROR   XXX.XXG

[Ctrl-X]Exit  [↑↓]Select  [B]Set Boot  [N]New Array  [ENTER]Detail

```

A new set of navigation keys is displayed on the bottom of the screen.

6. Press <Ctrl+X> to save settings and exit.

Rebuilding a RAID array

To rebuild a RAID array:

1. From the Array List menu, use the up or down arrow keys to select a RAID array then press <Enter>. The RAID Array details appear.

```

Array 1 : NVIDIA MIRROR XXX.XXG
- Array Detail -

RAID Mode: Mirroring
Striping Width: 1           Striping Block: 64K

  Adapt  Channel  M/S   Index  Disk Model Name      Capacity
  ----   -       -     -     -
  2      1      Master  0     XXXXXXXXXXXXXXXXXXXX  XXX.XXGB
  1      0      Master  1     XXXXXXXXXXXXXXXXXXXX  XXX.XXGB

[R] Rebuild  [D] Delete  [C] Clear Disk  [ENTER] Return

```

A new set of navigation keys is displayed on the bottom of the screen.

2. Press <R> to rebuild a RAID array. The following screen appears.

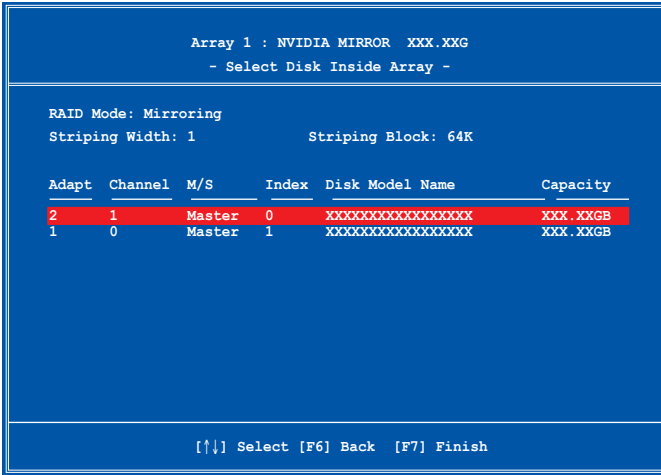

3. Use the up or down arrow keys to select a RAID array to rebuild, then press <F7>. The following confirmation message appears.



4. Press <Enter> to start rebuilding array or press <Esc> to cancel.
5. After the rebuild process, the Array list menu appears.

Deleting a RAID array

To delete a RAID array:

1. From the Array List menu, use the up or down arrow keys to select a RAID array then press <Enter>. The RAID Array details appear.

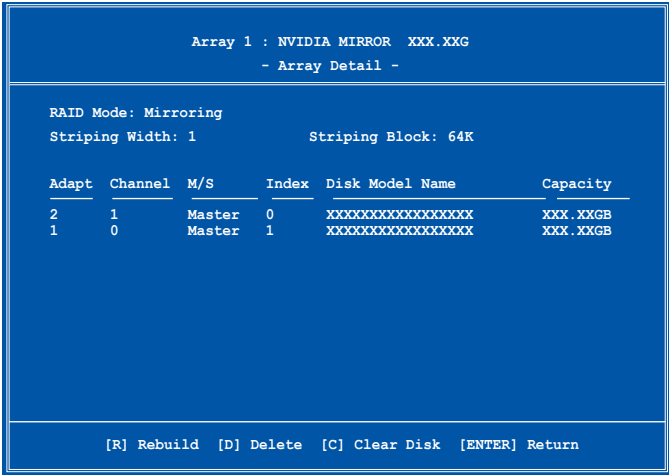

A new set of navigation keys is displayed on the bottom of the screen.

2. Press <D> to delete a RAID array. The following confirmation message appears.

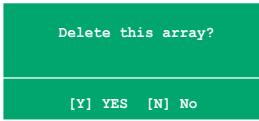

3. Press <Y> to delete array or press <N> to cancel.



Take caution in using this option. All data on the RAID drives will be lost!

4. If you selected Yes, the Define a New Array menu appears.

Clearing a disk data

To clear disk data:

1. From the Array List menu, use the up or down arrow keys to select a RAID array then press <Enter>. The RAID Array details appear.

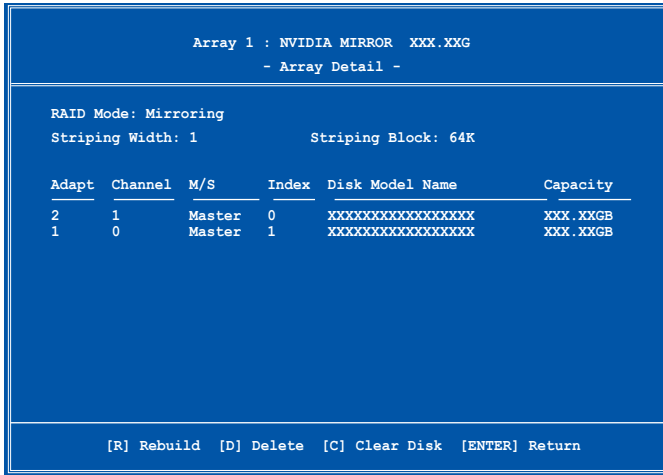

A new set of navigation keys is displayed on the bottom of the screen.

2. Press <C> to clear disk. The following confirmation message appears.

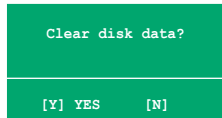

5. Press <Y> to clear the disk data or press <N> to cancel.



Take caution in using this option. All data on the RAID drives will be lost!

5.5.3 Silicon Image RAID configurations

The Silicon Image RAID controller supports RAID 0, RAID 1, RAID 0+1, JBOD, and RAID 5 configurations. Use the Silicon Image RAID utility to configure a disk array.

Setting the BIOS RAID items

After installing the hard disk drives, make sure to set the necessary RAID items in the BIOS before setting your RAID configuration.

To set the BIOS RAID items:

1. Boot the system and press during the Power-On Self-Test (POST) to enter the BIOS Setup Utility.
2. From the **Advanced > Onboard Devices Configuration** menu item in the BIOS set the **Silicon Image Controller** item to RAID Mode. See section “4.4.6 Onboard Devices Configuration” for details.
3. Save your changes and Exit Setup.

Launching the Silicon Image Array Management Software

Launch the Silicon Image Array Management software from Windows® XP by clicking the **Start** button and selecting **All Programs > Silicon Image > Sam**



-
- For details on the Silicon Image SATAraid™ RAID configuration, refer to the “Sil3114 User’s Manual” in your motherboard support CD.
 - You can only set the SATALink™ RAID 5 and JBOD configuration using the SATALink™ SATA RAID Management Software.
 - Make sure to install the Silicon Image SATA Link Sil 3114 driver and the Silicon Image RAID 5 Array Management Utility from the support CD before using RAID 5 configuration.
-

Entering the Silicon Image BIOS RAID Configuration Utility

To enter the Silicon Image BIOS RAID configuration utility:

1. Boot up your computer.



The RAID BIOS setup screens shown in this section are for reference only, and may not exactly match the items on your screen.

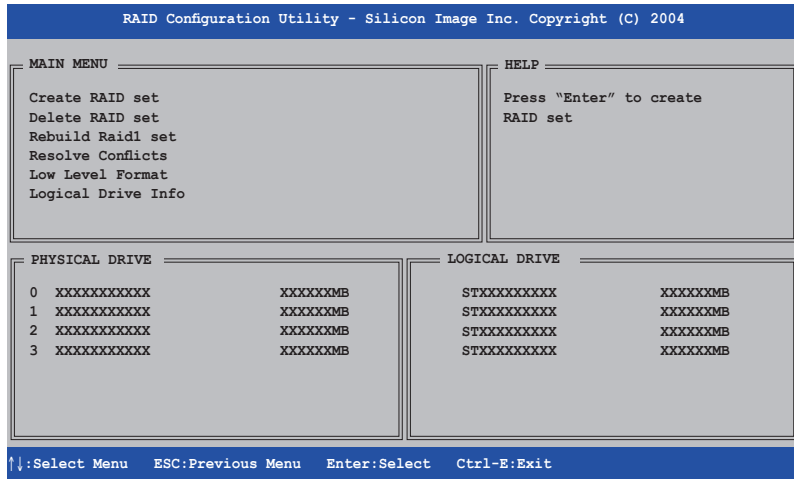

The Main Menu on the upper left corner allows you to select an operation to be performed. The Main Menu options include the following:

Create RAID set - creates a new legacy RAID set or allocates spare drives.

Delete RAID set - deletes a RAID set or deallocates a spare drive.

Rebuild RAID1 set - rebuilds a RAID 1 set (e.g. swapped drives).

Resolve Conflicts - automatically restores disrupted drives on a RAID set.

Low Level Format - creates a pattern of reference marks on a drive.

Formatting the disks erases all data previously stored in the drive.

Logical Drive Info - shows the current configuration of each RAID set.

On the upper right corner of the screen is the Help message box. The message describes the function of each menu item. At the bottom of the screen is the legend box. The keys on the legend box allow you to navigate through the setup menu options. The following lists the keys found in the legend box and their corresponding functions.

- ↑, ↓ : Select/Move to the next item
- ESC : Previous Menu
- Enter : Select
- Ctrl-E : Exit

Creating a RAID 0 set (Striped)

To create a RAID set:

1. From the Silicon Image configuration utility main menu, select **Create RAID set** then press <Enter> to display an option menu.

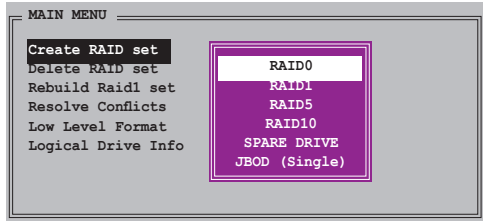

2. Select **RAID 0** then press <Enter> to display the following.

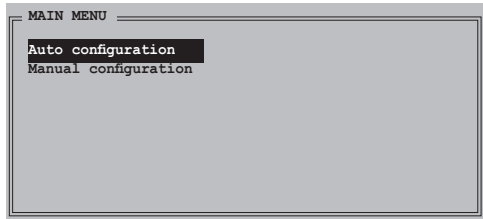

3. Select your desired method of configuration.
Auto configuration
 - a. Select Auto Configuration the press <Enter>.
 - b. The utility prompts a message to input the RAID size, use the up or down arrow keys to set the RAID size then press <Enter>.
 - c. Press <Y> to confirm or <N> to return to the Main Menu.



By default, Auto configuration sets the stripe size to 64K and sets the logical drives based on the physical drives installed.

Manual configuration

- a. Select **Manual configuration** and press <Enter>. The following pop-up menu appears.
- b. Use the up or down arrow keys to select a chunk size appropriate to your drive usage then press <Enter>.

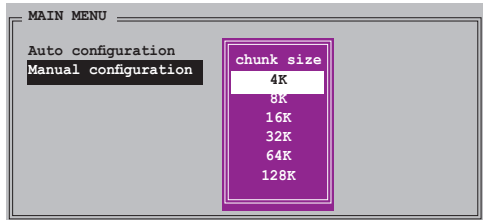



TIP: For server systems, we recommend using a lower array block size. For multimedia computer systems used mainly for audio and video editing, we recommend a higher array block size for optimum performance.

- c. The selection bar moves to the Physical Drive menu. Using the up or down arrow keys, select a drive then press <Enter> to set the first drive of the RAID set.

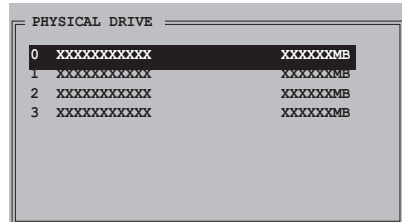

- d. Repeat step c to set the second, third, and fourth drive. The number of available drives depend on the installed and enabled physical drives in the system.
- e. The utility prompts a message to input the RAID size, use the up or down arrow keys to set the RAID size then press <Enter>.
- f. Press <Y> to confirm or <N> to return to the Main Menu.

Creating a RAID 1 set (Mirrored)

To create a RAID 1 set:

1. From the Silicon Image configuration utility main menu, select **Create RAID set** then press <Enter>. The following sub-menu appears.

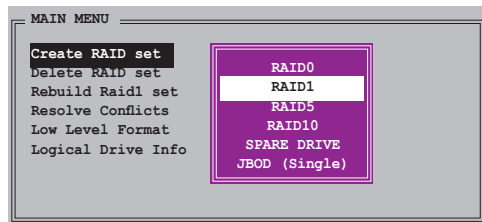

2. Select **RAID 1** then press <Enter> to display the following.

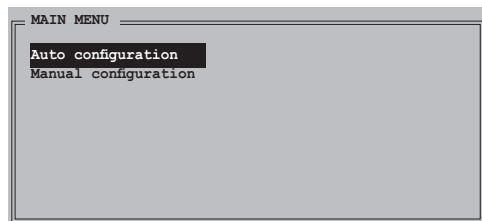

3. Select your desired method of configuration.

Auto configuration

- a. Select Auto Configuration then press <Enter>.
- b. The utility prompts a message to input the RAID size, use the up or down arrow keys to set the RAID size then press <Enter>.
- c. Press <Y> to confirm or <N> to return to the Main Menu.



- Auto-configuration creates a RAID 1 set without a backup copy of the current source disk data.
- When migrating a single hard disk drive to a RAID 1 set, use of the Manual configuration is recommended.

Manual configuration

- a. Select **Manual configuration** and press <Enter>. The selection bar moves to the Physical Drives menu.
- b. Using the up or down arrow keys, select the *source drive* and press <Enter>.
- c. Repeat step b to select the *target drive*.
- d. After selecting the source and target drives, the following pop-up menu appears.

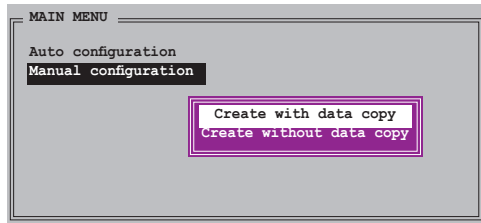
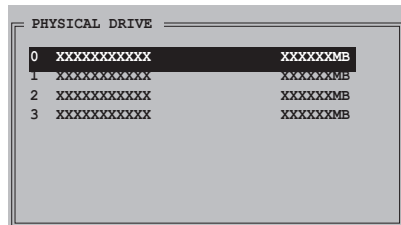

- The Create with data copy option allows you to copy the current data from the source drive to the mirror drive.
- Select Create with data copy if you have important data in your source drive.
- The Create without data copy option disables the disk copy function of the Mirrored set.
- If you selected Create without data copy, the RAID 1 set must be repartitioned and reformatted to guarantee the consistency of its contents.

- e. If you selected Create with data copy, the following pop-up menu appears.

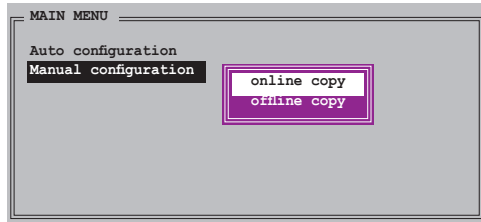

The **online copy** option automatically copies the data to the target drives on the background while writing to the source drives. The **offline copy** option allows you to copy the contents of the source drive to the target drives now.

- f. Use the up or down arrow keys to select desired copy method, then press <Enter>.
- g. The utility prompts a message to input the RAID size, use the up or down arrow keys to set the RAID size then press <Enter>.
- h. Press <Y> to confirm or <N> to return to the Main Menu.



A copy progress appears if you previously selected offline copy.

Creating a RAID 5 set (Parity)

To create a RAID 5 set:

1. From the Silicon Image configuration utility main menu, select **Create RAID set** then press <Enter>. The following sub-menu appears.
2. Select **RAID 5** then press <Enter> to display the following.

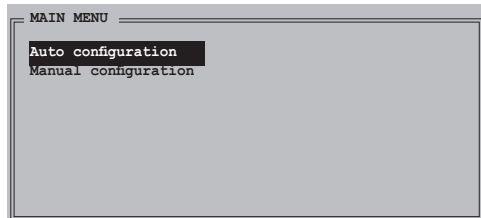
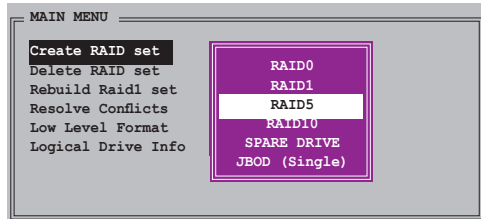

3. Select your desired method of configuration.
 - Auto configuration
 - a. Select Auto Configuration then press <Enter>.
 - b. The utility prompts a message to input the RAID size, use the up or down arrow keys to set the RAID size then press <Enter>.
 - c. Press <Y> to confirm or <N> to return to the Main Menu.

Manual configuration

- a. Select **Manual configuration** and press <Enter>. The following pop-up menu appears.
- b. Use the up or down arrow keys to select a chunk size appropriate to your drive usage then press <Enter>.

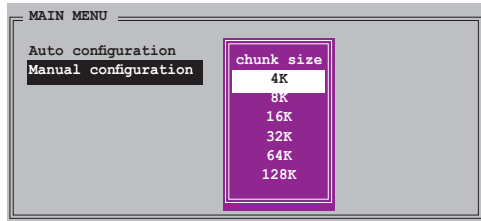

TIP: For server systems, we recommend using a lower array block size. For multimedia computer systems used mainly for audio and video editing, we recommend a higher array block size for optimum performance.

- c. The selection bar moves to the Physical Drive menu. Using the up or down arrow keys, select a drive then press <Enter> to set the first drive of the RAID set.

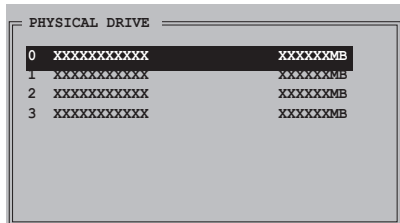

- d. Repeat step c to set the second, third and fourth drive. The number of available drives depend on the installed and enabled physical drives in the system.
- e. The utility prompts a message to input the RAID size, use the up or down arrow keys to set the RAID size then press <Enter>.
- f. Press <Y> to confirm or <N> to return to the Main Menu.

Creating a RAID 0+1 set (Mirrored+Striped)

To create a RAID 0+1 set:

1. From the Silicon Image configuration utility main menu, select **Create RAID set** then press <Enter>. The following sub-menu appears.

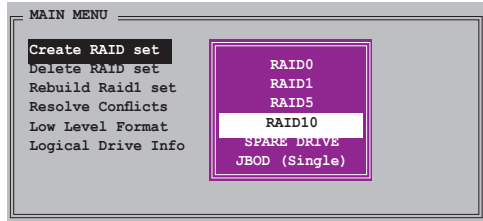

2. Select **RAID 0+1** then press <Enter> to display the following.

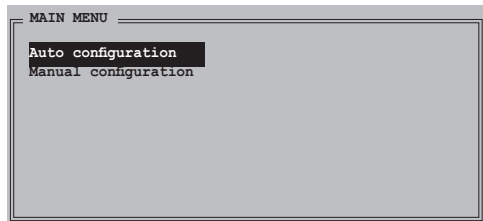

3. Select your desired method of configuration.

Auto configuration

- a. Select Auto Configuration then press <Enter>.
- b. The utility prompts a message to input the RAID size, use the up or down arrow keys to set the RAID size then press <Enter>.
- c. Press <Y> to confirm or <N> to return to the Main Menu.



Auto-configuration creates a RAID 0+1 set without a backup copy of the current source disk data.

Manual configuration

- a. Select Manual configuration and press <Enter>. The following pop-up menu appears.
- b. Use the up or down arrow keys to select a chunk size appropriate to your drive usage then press <Enter>.

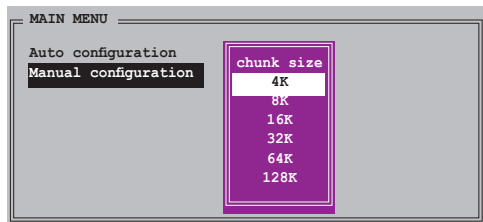

TIP: For server systems, use of a lower array block size is recommended. For multimedia computer systems used mainly for audio and video editing, a higher array block size is recommended for optimum performance.

- c. The selection bar moves to the Physical Drive menu. Using the up or down arrow keys, select a drive then press <Enter> to set the first drive of the RAID set.

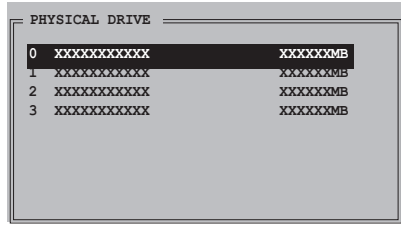

- d. Repeat step c to set the second, third, and fourth drive. The number of available drives depend on the installed and enabled physical drives in the system.
- e. After setting the RAID drives, the following pop-up menu appears.

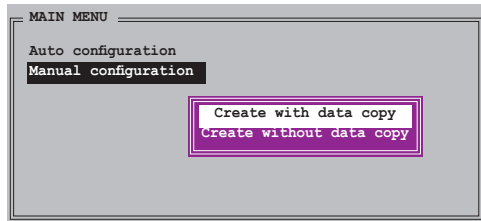

- The **Create with data copy** option allows you to copy the current data from the source drive to the mirror drive. The **Create without data copy** option disables the disk copy function of the Mirrored set.
- If you selected **Create without data copy**, the RAID 1 set must be repartitioned and reformatted to guarantee the consistency of its contents.
- Select **Create with data copy** if you have important data in your source drive.

- f. If you selected **Create with data copy**, the following pop-up menu appears.

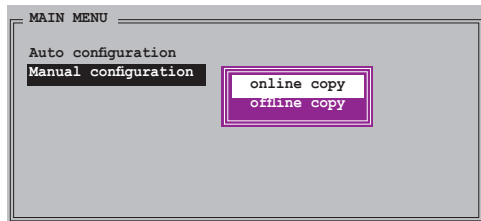

The online copy option automatically copies the data to the target drives on the background while writing to the source drives. The offline copy option allows you to copy the contents of the source drive to the target drives now.

- g. Use the up or down arrow keys to select desired copy method, then press <Enter>.
- h. The utility prompts a message to input the RAID size, use the up or down arrow keys to set the RAID size then press <Enter>.
- i. Press <Y> to confirm or <N> to return to the Main Menu. A copy progress appears if you previously selected offline copy.



- You can also create a RAID set using the SATARAID5 GUI utility under a Windows® environment.
- For details on the Silicon Image SATAraid™ RAID 5 configuration, refer to the “Sil3114 User’s Manual” found in your motherboard support CD.

Creating a JBOD set (Spanning)

To create a JBOD set:

1. From the Silicon Image configuration utility main menu, select **Create RAID set** then press <Enter>.
2. From the sub-menu Select **JBOD** then press <Enter>.
3. The selection bar moves to the Physical Drive menu. Using the up or down arrow keys, select a drive then press <Enter> to set a drive for the RAID set.
4. The utility prompts a message to input the RAID size, use the up or down arrow keys to set the RAID size then press <Enter>.
5. Press <Y> to confirm or <N> to return to the Main Menu.

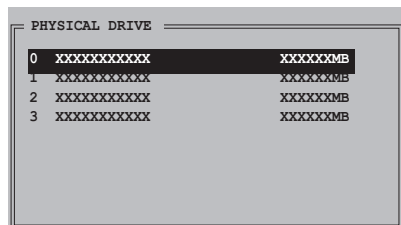
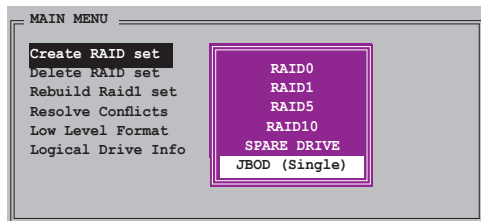

- Configure a JBOD (Single) set when using a single Serial ATA drive; otherwise, the system will not recognize the drive.
- You can also create a RAID set using the SATARAID5 GUI utility under a Windows® environment.

5.6 Creating a RAID driver disk

A floppy disk with the RAID driver is required when installing Windows® 2000/XP operating system on a hard disk drive that is included in a RAID set.

To create a RAID driver disk:

1. Place the motherboard support CD into the CD-ROM drive.
2. When the Drivers menu appears, select the RAID driver disk you want to create:
 - Click **Make NVIDIA RAID Driver** to create an NVIDIA® RAID driver disk.
 - Click **Make Silicon SATA RAID Driver Disk** to create a Silicon Image SATAraid™ RAID driver disk.

Or

Browse the contents of the support CD to locate the driver disk utility.

- Go to `\Drivers\Chipset\WINXP_2K\Driver_Disk` for the NVIDIA® RAID driver disk utility.
- Go to `\Drivers\Sil3114` for the Silicon Image RAID driver disk utility.



Refer to section “5.2.2 Drivers menu” for details.

4. Insert floppy disk to floppy disk drive.
5. Follow succeeding screen information to complete process.
6. Write-protect the floppy disk to avoid computer virus infection.

To install the RAID driver:

1. During the OS installation, the system prompts you to press the F6 key to install third-party SCSI or RAID driver.
2. Press <F6> then insert the floppy disk with RAID driver into the floppy disk drive.
3. Follow the succeeding screen instructions to complete the installation.



Due to chipset limitation, the Serial ATA ports supported by the NVIDIA chipset doesn't support Serial Optical Disk Drives (Serial ODD) under DOS.

5.7 Cool 'n' Quiet!™ Technology

The motherboard supports the AMD Cool 'n' Quiet!™ Technology that dynamically and automatically change the CPU speed, voltage, and amount of power depending on the task the CPU performs.

5.7.1 Enabling Cool 'n' Quiet!™ Technology

To enable Cool 'n' Quiet!™ Technology:

1. Turn on the system and enter BIOS by pressing the key during the Power On Self-Tests (POST).
2. In the **Advanced > CPU Configuration > AMD CPU Cool & Quiet Configuration** menu, select the item **Cool N'Quiet** and set it to **Enabled**. See section “4.4 Advanced Menu” in the user guide.
3. In the **Power** menu, select the item **ACPI 2.0 Support** and set it to **Yes**. See section “4.5 Power Menu” in the user guide.
4. Save your changes and exit BIOS Setup.
5. Reboot your computer and set your Power Option Properties depending on your operating system.

Windows® 2000/XP

1. From the Windows® 2000/XP operating system, click the **Start** button. Select **Settings**, then **Control Panel**.
2. Make sure the Control Panel is set to Classic View.
3. Double-click the **Display** icon in the Control Panel then select the **Screen Saver** tab.
4. Click the **Power...** button. The following dialog box appears.
5. From the **Power schemes** combo list box, select **Minimal Power Management**.
6. Click **OK** to effect settings.



Make sure to install the Cool 'n' Quiet!™ driver and application before using this feature.

5.7.2 Launching the Cool 'n' Quiet!™ software

The motherboard support CD includes the Cool 'n' Quiet!™ software that enables you to view your system's real-time CPU Frequency and voltage.



Make sure to install the Cool 'n' Quiet!™ software from the motherboard support CD. Refer to section “5.2.3 Utilities menu”, for details.

To launch the Cool 'n' Quiet!™ program:

1. If you are using Windows® 98SE/ME/2000, click the **Start** button. Select **Programs > ASUS > Cool & Quiet > Cool & Quiet**.
2. If you are using Windows® XP, click the **Start** button. Select **All Programs > ASUS > Cool & Quiet > Cool & Quiet**.
3. The Cool 'n' Quiet!™ technology screen appears and displays the current CPU Frequency and CPU Voltage.

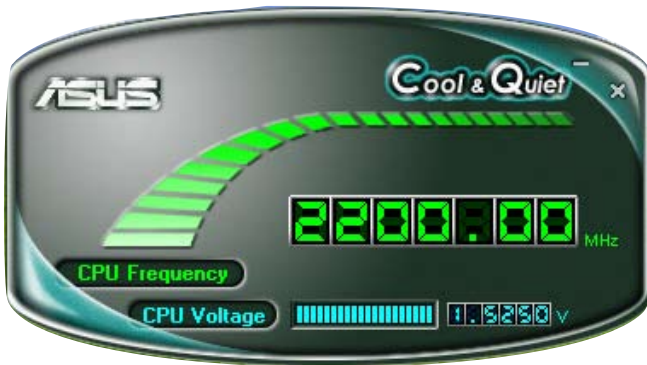

5.8 Using the NVIDIA® nTune™ utility

The motherboard supports the NVIDIA® nTune™ utility that allows easy and safe system tuning for optimum performance. This utility provides the safest and easiest way to tweak voltages or change system bus speeds and memory timings for maximum system performance.

Follow the **NVIDIA Chipset Driver Program** installation wizard to install the NVIDIA® nTune™ utility from the motherboard support CD.

After you have successfully installed the utility in your computer, launch the nTune™ utility from the Windows® desktop by clicking **Start > All Programs > NVIDIA Corporation > nTune > nTune** from the Windows® taskbar.

5.8.1 Managing your nForce™ system

The Manage my nForce™ system menu allows you to benchmark and automatically tune your system, manage your nTune™ profiles, monitor your system, troubleshoot performance, create a log, get online support or update the BIOS. This menu also provides shortcuts to manage your nForceware™ settings.



Click to launch Manage my nForce™ system menu

5.8.2 Clock control

The Clock control menu allows dynamic modifications for system bus speeds and memory controller timing. The system bus speed includes the front side bus (FSB) and AGP bus.



Click to launch the Clock control menu

5.8.3 Voltage/Fan control

The Voltage/Fan control menu allows tweaking options for the CPU and memory voltage. This menu also allows dynamic modifications for the CPU and auxiliary fan speeds.

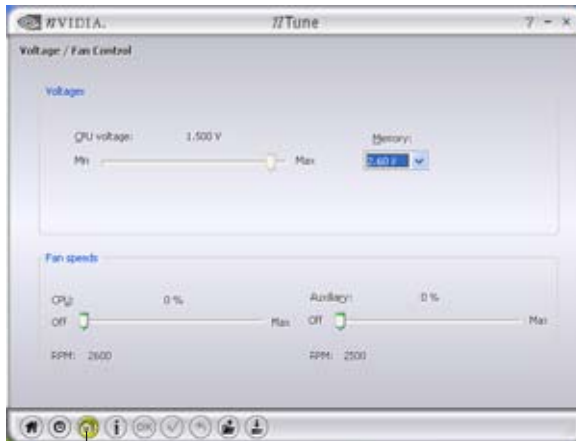

Click to launch the Voltage/Fan menu

5.8.4 Information

The information page displays related information about the processor, memory, motherboard, nForce™ profile, version information, and the calculated system performance results.



Click to launch the Information page

5.8.5 Other options

Other option buttons allow you to easily save or revert your settings and save or load nTune™ profiles.



Click to save settings and exit

Click to save settings only

Click to revert changes

Click to load saved nTune™ profile

Click to save settings in a profile

5.9 Using the ASUS AI Selector utility

The motherboard support CD comes with the ASUS AI Selector that allows you to set the video card mode of your system.

Follow the **AI Selector** installation wizard to install the AI Selector utility from the motherboard support CD.



Use this utility only when you have two graphics cards installed in your system.

5.9.1 Launching the ASUS AI Selector

After you have successfully installed the utility in your computer, launch the AI Selector utility from the Windows® desktop by clicking **Start > All Programs > ASUS > AI Selector > AI Selector** from the Windows® taskbar.

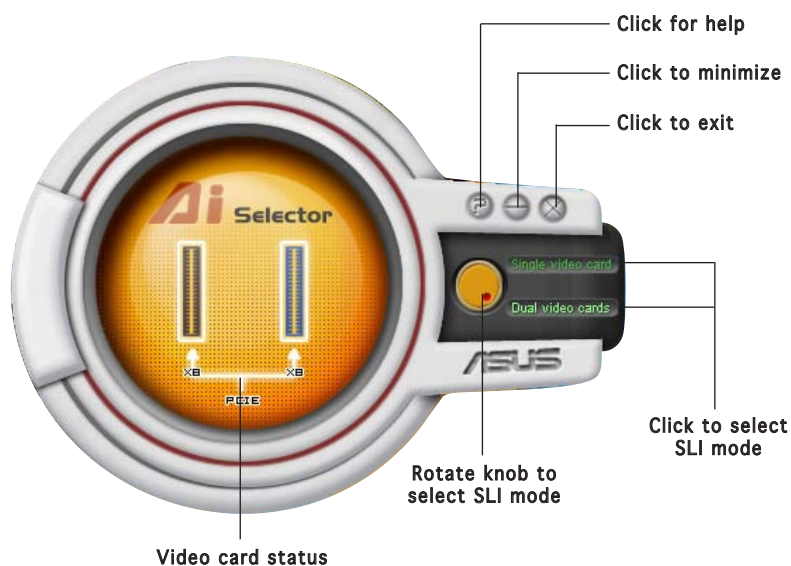

Single Video Card mode - the primary (blue) PCI Express x16 slot works at the bandwidth of PCI Express x16.

Dual Video Card mode - the primary (blue) and secondary (black) PCI Express x16 slots runs in x8 mode. The combined bandwidth of these maintain the bandwidth of PCI Express x16.

The utility prompts you to restart your system after setting the video card mode.

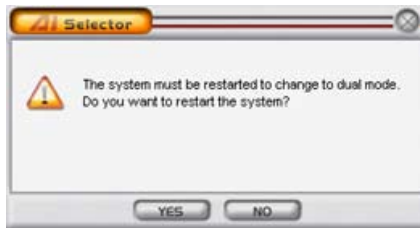

Click **Yes** to implement settings and restart your system or **No** to return to the AI Selector menu.

5.9.2 Using the SLI mode

To use SLI mode:

1. Set the **SLI Multi-GPU** feature in Display Properties. See section “6.2.4 Enabling the multi-GPU feature in Windows” on page 6-7 for details.
2. Select **Dual video card**.
3. When prompted, click **Yes** to restart your system.



-
- When the SLI mode is disabled, the multi-monitor feature is automatically enabled. Use the NVIDIA nView utility to configure your multi-monitor setup.
 - Refer to section “4.4.4 SLI Configuration” on page 4-29 for BIOS details.
-

This chapter tells how to install
SLI-ready PCI Express graphics cards.

NVIDIA® SLI™ **technology** **support**



Chapter summary

6.1	Overview	6-1
6.2	Dual graphics cards setup.....	6-3

6.1 Overview

The motherboard supports the NVIDIA® SLI™ (Scalable Link Interface) technology that allows you to install two identical PCI Express™ x16 graphics cards. Follow the installation procedures in this section.

6.1.1 Requirements

- You should have two identical SLI-ready graphics cards that are NVIDIA® certified.
- Visit the ASUS website (www.asus.com) for a list of qualified SLI-ready graphics cards for this motherboard.
- Make sure that your graphics card driver supports the NVIDIA SLI technology. Download the latest driver from the NVIDIA website (www.nvidia.com).
- Make sure that your power supply unit (PSU) can provide at least the minimum power required by your system. See “8. ATX power connectors” on page 2-26 for details.



- The NVIDIA SLI technology supports Windows® XP™ operating system only.
- Visit the NVIDIA website for the supported 3D applications.
- Visit the NVIDIA zone website (<http://www.nzone.com>) for the latest certified graphics card list.

6.1.2 ASUS Certified SLI Graphics cards

Use only ASUS certified PCI Express x16 SLI graphics cards to ensure optimum performance.

GeForce 6800 Ultra models

Vendor	Model Number
ASUS	Extreme N6800Ultra (EN6800Ultra)
BFG	BFGO68256UX
eVGA	256-P2-N377-AX/BX
Gainward	PowerPack! Ultra/2600 PCX “Golden Sample”
Gigabyte	GV-NX68U256D-B
Leadtek	WinFast PX6800 Ultra
MSI	MS-8974
XFX/Pine	XFX GeForce 6800 Ultra

GeForce 6800 GT models

Vendor	Model Number
ASUS	EN6800GT
BFG	BFG BFG068256GTOCX
eVGA	256-P2-N376-AX/BX
Gigabyte	GV-NX68T256DH
Leadtek	WinFast PX6800 GT
XFX/Pine	XFX GeForce 6800GT PCI-E (PV-T45G-UD)

GeForce 6600 GT models

Vendor	Model Number
Albatron	GF6600GT
AOpen	Aeolus 6600GT-DV128
Asus	Extreme N6600GT
BFG	BFGR6600GTOCX
Chaintech	SE6600G
eVGA	128-P2-N368-AX/BX
Gigabyte	NX66T128D
Leadtek	WinFast PX6600GT
MSI	MS-8983 NX6600GT-VTD128E/NX6600GT-TD128E
Palit	GeForce 6600GT
Prolink	PV-NV43E(128LD)
Sparkle	SPPX43
XFX/Pine	XFX GeForce 6600GT PCI-E (PV-T43G-ND)

6.2 Dual graphics card setup

6.2.1 Installing SLI-ready graphics cards



Install only identical SLI-ready graphics cards that are ASUS and NVIDIA® certified. Different types of graphics cards will not work together properly.

To install the graphics cards:

1. Prepare two graphics cards. Each graphics card should have goldfingers for the SLI connector.

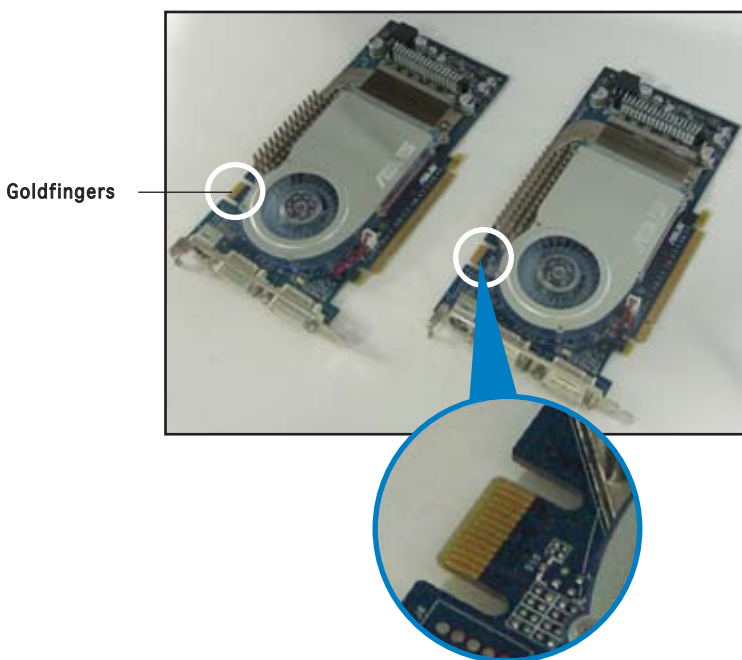

2. Remove the metal bracket covers opposite the two PCI Express x16 slots.

3. Insert one graphics card into the blue slot labeled **PCIEX16_1**. Make sure that the card is properly seated on the slot.



4. Insert the second graphics card into the black slot labeled **PCIEX16_2**. Make sure that the card is properly seated on the slot.



If required, connect an auxiliary power source to the PCI Express graphics cards.

5. Align and insert the SLI flexible cable connector to the goldfingers on each graphics card. Make sure that the connector is firmly in place.

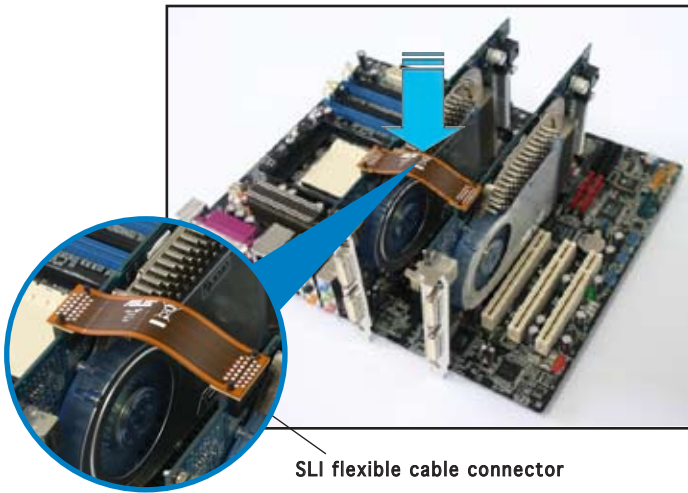

6. If using a 20-pin ATX power connector, connect a 4-pin ATX power cable to the EZ Plug™ labeled EZ_PLUG on your motherboard.

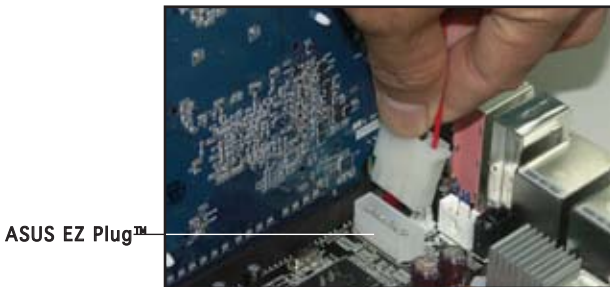

The onboard red warning LED lights up if you do not plug a 4-pin ATX power cable to the EZ Plug.

7. Connect a **VGA cable** or a **DVI-I cable** to the graphics card installed on the **blue** PCI Express slot.

6.2.2 Installing the device drivers

Refer to the documentation that came with your graphics card package to install the device drivers.



Make sure that your PCI Express graphics card driver supports the NVIDIA SLI technology. Download the latest driver from the NVIDIA website (www.nvidia.com).

6.2.3 Installing the ASUS AI Selector utility

Install the ASUS AI Selector utility using the motherboard support CD. Follow the steps described in section “5.2.3 Utilities menu” to install the ASUS AI Selector utility.

6.2.4 Enabling the multi-GPU feature in Windows

After installing your graphics cards and the device drivers, enable the Multi-Graphics Processing Unit (GPU) feature in the NVIDIA nView properties.

To enable the multi-GPU feature:

1. Click the **NVIDIA Settings** icon on your Windows taskbar.



NVIDIA Settings icon

2. From the pop-up menu, select **nView Desktop Manager** then click **nView Properties**.

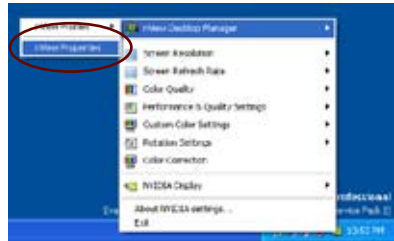

3. From the nView Desktop Manager window, select the **Desktop Management** tab.
4. Click **Properties** to display the Display Properties dialog box.



- From the Display Properties dialog box, select the **Settings** tab then click **Advanced**.



- Select the **NVIDIA GeForce** tab.



- Click the slider to display the following screen, then select the **SLI multi-GPU** item.



8. Click the **Enable SLI multi-GPU** check box.
9. Click **OK** when done.

6.2.5 Setting the ASUS AI Selector utility

From the AI Selector utility, select **Dual Video Cards** then click **Yes** to restart your system. Refer to Table 1 below for the AI Selector card settings.

Table 1 AI Selector settings

AI Selector setting		PCIEX16_1 (blue) slot	PCIEX16_2 (black) slot		
		Card Type	Speed	Card Type	Speed
Single Video Card		Qualified PCIe x16 graphics card	x16	-	-
Dual Video Card	SLI mode	Qualified SLI-ready graphics cards	x8	Qualified SLI-ready graphics card	x8
	Multi-monitor, RAID or LAN setup	Qualified PCIe x16 graphics card	x8	Qualified PCIe graphics card, RAID or LAN card	x8, x4, x2, x1



- When the SLI mode is disabled, the multi-monitor mode is automatically enabled. Use the NVIDIA nView utility to configure your multi-monitor setup.
- See section “5.9 Using the ASUS AI Selector utility” on page 5-46 for details.

This chapter describes the contents of the support CD that comes with the motherboard package.

Appendix

Chapter summary

A.1	Using the SATA extension module	A-1
-----	---------------------------------------	-----

A.1 Using the SATA extension module

Your motherboard package comes with a 2-port Serial ATA extension module that allows you to externally connect two Serial ATA hard drives.

A.1.1 Installing the 2-port SATA extension module

To install your 2-port Serial ATA extension module:

1. Select an available expansion card slot on the rear panel of your chassis.
2. Place the 2-port Serial ATA extension module on the available slot and secure it with a screw.
3. Select any two (2) SATA connectors on your motherboard.
4. Connect one end of the first SATA signal cable to one of the selected SATA connectors.
5. Connect the other end of the SATA signal cable to the SATA connector on the extension module labeled **SATA_CON3**.
6. Connect one end of the second Serial ATA signal cable to another SATA connector.
7. Connect the other end of the second SATA signal cable to the SATA connector on the extension module labeled **SATA_CON4**.
8. Connect a 4-pin ATX power plug to the SATA extension module power connector labeled **PWR_CON1**.
9. You can now connect two SATA hard disks to the rear panel of your chassis.

A.1.2 Installing SATA hard drives

To install Serial ATA hard drives:

1. Connect one end of the first SATA signal cable to the SATA connector labeled **SATA 1**.
2. Connect the other end of the SATA signal cable to the SATA connector on the first drive.
3. Connect one end of the second SATA signal cable to the other SATA connector labeled **SATA 2**.
4. Connect the other end of the second SATA signal cable to the SATA connector on the second drive.
5. Connect the 4-pin ATX SATA power plug to the SATA extension module.



Your Serial ATA power plug comes with one (1) 4-pin ATX power connector and two (2) Serial ATA power connectors.

6. Connect one SATA power connector to the first drive.
7. Connect the other Serial ATA power connector to the second drive.

