

**A8V-VM**  
*Ultra*

**ASUS**<sup>®</sup>

**Motherboard**

**E2504**

**First Edition**

**April 2006**

Copyright © 2006 ASUSTeK COMPUTER INC. All Rights Reserved.

No part of this manual, including the products and software described in it, may be reproduced, transmitted, transcribed, stored in a retrieval system, or translated into any language in any form or by any means, except documentation kept by the purchaser for backup purposes, without the express written permission of ASUSTeK COMPUTER INC. ("ASUS").

Product warranty or service will not be extended if: (1) the product is repaired, modified or altered, unless such repair, modification or alteration is authorized in writing by ASUS; or (2) the serial number of the product is defaced or missing.

ASUS PROVIDES THIS MANUAL "AS IS" WITHOUT WARRANTY OF ANY KIND, EITHER EXPRESS OR IMPLIED, INCLUDING BUT NOT LIMITED TO THE IMPLIED WARRANTIES OR CONDITIONS OF MERCHANTABILITY OR FITNESS FOR A PARTICULAR PURPOSE. IN NO EVENT SHALL ASUS, ITS DIRECTORS, OFFICERS, EMPLOYEES OR AGENTS BE LIABLE FOR ANY INDIRECT, SPECIAL, INCIDENTAL, OR CONSEQUENTIAL DAMAGES (INCLUDING DAMAGES FOR LOSS OF PROFITS, LOSS OF BUSINESS, LOSS OF USE OR DATA, INTERRUPTION OF BUSINESS AND THE LIKE), EVEN IF ASUS HAS BEEN ADVISED OF THE POSSIBILITY OF SUCH DAMAGES ARISING FROM ANY DEFECT OR ERROR IN THIS MANUAL OR PRODUCT.

SPECIFICATIONS AND INFORMATION CONTAINED IN THIS MANUAL ARE FURNISHED FOR INFORMATIONAL USE ONLY, AND ARE SUBJECT TO CHANGE AT ANY TIME WITHOUT NOTICE, AND SHOULD NOT BE CONSTRUED AS A COMMITMENT BY ASUS. ASUS ASSUMES NO RESPONSIBILITY OR LIABILITY FOR ANY ERRORS OR INACCURACIES THAT MAY APPEAR IN THIS MANUAL, INCLUDING THE PRODUCTS AND SOFTWARE DESCRIBED IN IT.

Products and corporate names appearing in this manual may or may not be registered trademarks or copyrights of their respective companies, and are used only for identification or explanation and to the owners' benefit, without intent to infringe.

# Table of contents

|                                           |     |
|-------------------------------------------|-----|
| Notices .....                             | vi  |
| Safety information .....                  | vii |
| A8V-VM Ultra specifications summary ..... | x   |

## Chapter 1: Product introduction

|        |                                       |      |
|--------|---------------------------------------|------|
| 1.1    | Welcome! .....                        | 1-2  |
| 1.2    | Package contents .....                | 1-2  |
| 1.3    | Special features .....                | 1-3  |
| 1.3.1  | Product highlights .....              | 1-3  |
| 1.3.2  | Innovative ASUS features .....        | 1-4  |
| 1.4    | Before you proceed .....              | 1-5  |
| 1.5    | Motherboard overview .....            | 1-6  |
| 1.5.1  | Motherboard layout .....              | 1-6  |
| 1.5.2  | Placement direction .....             | 1-6  |
| 1.5.3  | Screw holes .....                     | 1-7  |
| 1.6    | Central Processing Unit (CPU) .....   | 1-8  |
| 1.6.1  | Overview .....                        | 1-8  |
| 1.6.2  | Installing the CPU .....              | 1-8  |
| 1.6.3  | Installing the heatsink and fan ..... | 1-10 |
| 1.7    | System memory .....                   | 1-12 |
| 1.7.1  | Overview .....                        | 1-12 |
| 1.7.2  | Memory configurations .....           | 1-12 |
| 1.7.3  | Installing a DIMM .....               | 1-15 |
| 1.7.4  | Removing a DIMM .....                 | 1-15 |
| 1.8    | Expansion slots .....                 | 1-16 |
| 1.8.1  | Installing an expansion card .....    | 1-16 |
| 1.8.2  | Configuring an expansion card .....   | 1-16 |
| 1.8.3  | PCI slots .....                       | 1-18 |
| 1.8.4  | PCI Express x1 slot .....             | 1-18 |
| 1.8.5  | PCI Express x16 slot .....            | 1-18 |
| 1.9    | Jumpers .....                         | 1-19 |
| 1.10   | Connectors .....                      | 1-21 |
| 1.10.1 | Rear panel connectors .....           | 1-21 |
| 1.10.2 | Internal connectors .....             | 1-22 |

# Table of contents

## Chapter 2: BIOS setup

- 2.1 Managing and updating your BIOS ..... 2-2
  - 2.1.1 Creating a bootable floppy disk ..... 2-2
  - 2.1.2 ASUS EZ Flash utility ..... 2-3
  - 2.1.3 AFUDOS utility ..... 2-4
  - 2.1.4 ASUS CrashFree BIOS 2 utility ..... 2-6
  - 2.1.5 ASUS Update utility ..... 2-8
- 2.2 BIOS setup program..... 2-11
  - 2.2.1 BIOS menu screen..... 2-12
  - 2.2.2 Menu bar ..... 2-12
  - 2.2.3 Navigation keys..... 2-12
  - 2.2.4 Menu items ..... 2-13
  - 2.2.5 Sub-menu items..... 2-13
  - 2.2.6 Configuration fields ..... 2-13
  - 2.2.7 Pop-up window..... 2-13
  - 2.2.8 Scroll bar ..... 2-13
  - 2.2.9 General help ..... 2-13
- 2.3 Main menu..... 2-14
  - 2.3.1 System Time ..... 2-14
  - 2.3.2 System Date ..... 2-14
  - 2.3.3 Legacy Diskette A ..... 2-14
  - 2.3.4 Primary, Secondary, Third, Fourth IDE Master/Slave .... 2-15
  - 2.3.5 IDE Configuration ..... 2-16
  - 2.3.6 System Information..... 2-17
- 2.4 Advanced menu ..... 2-18
  - 2.4.1 CPU Configuration ..... 2-18
  - 2.4.2 Chipset ..... 2-19
  - 2.4.3 Onboard Devices Configuration..... 2-26
  - 2.4.4 PCI PnP ..... 2-27
- 2.5 Power menu ..... 2-28
  - 2.5.1 ACPI 2.0 Support ..... 2-28
  - 2.5.2 ACPI APIC Support ..... 2-28

# Table of contents

|       |                                   |      |
|-------|-----------------------------------|------|
| 2.5.3 | APM Configuration .....           | 2-29 |
| 2.5.4 | Hardware Monitor.....             | 2-31 |
| 2.6   | Boot menu .....                   | 2-32 |
| 2.6.1 | Boot Device Priority .....        | 2-32 |
| 2.6.2 | Boot Settings Configuration ..... | 2-33 |
| 2.6.3 | Security.....                     | 2-34 |
| 2.7   | Exit menu.....                    | 2-36 |

## Chapter 3: Software support

|       |                                     |     |
|-------|-------------------------------------|-----|
| 3.1   | Installing an operating system..... | 3-2 |
| 3.2   | Support CD information .....        | 3-2 |
| 3.2.1 | Running the support CD.....         | 3-2 |
| 3.2.2 | Drivers menu .....                  | 3-3 |
| 3.2.3 | Utilities menu .....                | 3-4 |
| 3.2.4 | Make disk menu .....                | 3-5 |
| 3.2.4 | Manual.....                         | 3-6 |
| 3.2.5 | ASUS Contact information .....      | 3-6 |

# Notices

## Federal Communications Commission Statement

This device complies with Part 15 of the FCC Rules. Operation is subject to the following two conditions:

- This device may not cause harmful interference, and
- This device must accept any interference received including interference that may cause undesired operation.

This equipment has been tested and found to comply with the limits for a Class B digital device, pursuant to Part 15 of the FCC Rules. These limits are designed to provide reasonable protection against harmful interference in a residential installation. This equipment generates, uses and can radiate radio frequency energy and, if not installed and used in accordance with manufacturer's instructions, may cause harmful interference to radio communications. However, there is no guarantee that interference will not occur in a particular installation. If this equipment does cause harmful interference to radio or television reception, which can be determined by turning the equipment off and on, the user is encouraged to try to correct the interference by one or more of the following measures:

- Reorient or relocate the receiving antenna.
- Increase the separation between the equipment and receiver.
- Connect the equipment to an outlet on a circuit different from that to which the receiver is connected.
- Consult the dealer or an experienced radio/TV technician for help.



---

The use of shielded cables for connection of the monitor to the graphics card is required to assure compliance with FCC regulations. Changes or modifications to this unit not expressly approved by the party responsible for compliance could void the user's authority to operate this equipment.

---

## Canadian Department of Communications Statement

This digital apparatus does not exceed the Class B limits for radio noise emissions from digital apparatus set out in the Radio Interference Regulations of the Canadian Department of Communications.

**This class B digital apparatus complies with Canadian ICES-003.**

# Safety information

## Electrical safety

- To prevent electrical shock hazard, disconnect the power cable from the electrical outlet before relocating the system.
- When adding or removing devices to or from the system, ensure that the power cables for the devices are unplugged before the signal cables are connected. If possible, disconnect all power cables from the existing system before you add a device.
- Before connecting or removing signal cables from the motherboard, ensure that all power cables are unplugged.
- Seek professional assistance before using an adapter or extension cord. These devices could interrupt the grounding circuit.
- Make sure that your power supply is set to the correct voltage in your area. If you are not sure about the voltage of the electrical outlet you are using, contact your local power company.
- If the power supply is broken, do not try to fix it by yourself. Contact a qualified service technician or your retailer.

## Operation safety

- Before installing the motherboard and adding devices on it, carefully read all the manuals that came with the package.
- Before using the product, make sure all cables are correctly connected and the power cables are not damaged. If you detect any damage, contact your dealer immediately.
- To avoid short circuits, keep paper clips, screws, and staples away from connectors, slots, sockets and circuitry.
- Avoid dust, humidity, and temperature extremes. Do not place the product in any area where it may become wet.
- Place the product on a stable surface.
- If you encounter technical problems with the product, contact a qualified service technician or your retailer.



---

The symbol of the crossed out wheeled bin indicates that the product (electrical and electronic equipment) should not be placed in municipal waste. Check local regulations for disposal of electronic products.

---

# About this guide

This user guide contains the information you need when installing and configuring the motherboard.

## How this guide is organized

This manual contains the following parts:

- **Chapter 1: Product introduction**  
This chapter describes the features of the motherboard and the new technology it supports. It also lists the hardware setup procedures that you have to perform when installing system components. It includes description of the jumpers and connectors on the motherboard.
- **Chapter 2: BIOS setup**  
This chapter tells how to change system settings through the BIOS Setup menu. Detailed descriptions of the BIOS parameters are also provided.
- **Chapter 3: Software support**  
This chapter describes the contents of the support CD that comes with the motherboard package.

## Where to find more information

Refer to the following sources for additional information and for product and software updates.

### 1. ASUS websites

The ASUS website provides updated information on ASUS hardware and software products. Refer to the ASUS contact information.

### 2. Optional documentation

Your product package may include optional documentation, such as warranty flyers, that may have been added by your dealer. These documents are not part of the standard package.



## Conventions used in this guide

To make sure that you perform certain tasks properly, take note of the following symbols used throughout this manual.



**DANGER/WARNING:** Information to prevent injury to yourself when trying to complete a task.



**CAUTION:** Information to prevent damage to the components when trying to complete a task.



**IMPORTANT:** Instructions that you **MUST** follow to complete a task.



**NOTE:** Tips and additional information to help you complete a task.

## Typography

**Bold text**

Indicates a menu or an item to select

*Italics*

Used to emphasize a word or a phrase

<Key>

Keys enclosed in the less-than and greater-than sign means that you must press the enclosed key

Example: <Enter> means that you must press the Enter or Return key

<Key1> + <Key2> + <Key3>

If you must press two or more keys simultaneously, the key names are linked with a plus sign (+)

Example: <Ctrl> + <Alt> + <Del>

**Command**

Means that you must type the command exactly as shown, then supply the required item or value enclosed in brackets

Example: At the DOS prompt, type the command line:

**awdf`flash` A8VVMUT.ROM**

## A8V-VM Ultra specifications summary

|                              |                                                                                                                                                                                               |
|------------------------------|-----------------------------------------------------------------------------------------------------------------------------------------------------------------------------------------------|
| <b>CPU</b>                   | Socket 939 for AMD® Athlon™ 64/Sempron™/Opteron™ processors<br>Supports AMD 64 architecture that enables simultaneous 32-bit and 64-bit computing<br>Supports AMD Cool 'n' Quiet!™ Technology |
| <b>Chipset</b>               | Northbridge: VIA® K8M890<br>Southbridge: VIA® VT8237A                                                                                                                                         |
| <b>System Bus</b>            | 1GH/z                                                                                                                                                                                         |
| <b>Memory</b>                | Dual-channel memory architecture<br>2 x 184-pin DIMM sockets support unbuffered ECC/<br>non-ECC DDR 400/333/266 MHz memory modules<br>Supports up to 2 GB system memory                       |
| <b>VGA</b>                   | Integrated Gfx in North bridge                                                                                                                                                                |
| <b>Expansion slots</b>       | 1 x PCI Express x16 slot<br>1 x PCI Express x1 slot<br>2 x PCI slots                                                                                                                          |
| <b>Storage</b>               | VIA® VT8237A South Bridge supports:<br>- 2 x Ultra DMA 133/100/66/33<br>- 2 x Serial ATA devices with RAID 0, RAID 1, and JBOD configurations                                                 |
| <b>Audio</b>                 | Realtek® ALC660 6-channel CODEC                                                                                                                                                               |
| <b>USB</b>                   | Supports up to 8 USB 2.0 ports                                                                                                                                                                |
| <b>LAN</b>                   | Realtek® RTL8201CL 10/100M LAN PHY                                                                                                                                                            |
| <b>ASUS special features</b> | ASUS MyLogo<br>ASUS EZ Flash<br>ASUS CrashFree BIOS 2                                                                                                                                         |
| <b>BIOS features</b>         | 4 Mb Flash ROM, AMI BIOS, PnP, DMI2.0, WfM2.0, SM BIOS 2.3                                                                                                                                    |
| <b>Back Panel I/O Ports</b>  | 1 x Parallel port<br>1 x Serial port<br>1 x PS/2 keyboard port<br>1 x PS/2 mouse port<br>1 x RJ45 port<br>4 x USB 2.0 ports<br>1 x 6-Channel Audio I/O port<br>1 x VGA port                   |

*(continued on the next page)*

# A8V-VM Ultra specifications summary

|                                |                                                                                                                                                                                                                                                         |
|--------------------------------|---------------------------------------------------------------------------------------------------------------------------------------------------------------------------------------------------------------------------------------------------------|
| <b>Internal I/O connectors</b> | 1 x 24-pin ATX power connector<br>1 x 4-pin ATX 12V power connector<br>2 x USB connectors for four additional USB 2.0 ports<br>1 x Front panel audio connector<br>CPU/Chassis fan connectors<br>1 x CD audio-in connector<br>1 x System panel connector |
| <b>Manageability</b>           | Wfm2.0, DMi2.0, WOL by PME, WOR by PME, PXE, RPL                                                                                                                                                                                                        |
| <b>Support CD contents</b>     | Device drivers<br>ASUS PC Probe II<br>ASUS LiveUpdate Utility<br>Anti-Virus software                                                                                                                                                                    |
| <b>Form Factor</b>             | ATX Form Factor: 9.6 in x 7.8 in (24.4 cm x 19.4 cm)                                                                                                                                                                                                    |

\*Specifications are subject to change without notice.



This chapter describes the motherboard features and the new technologies it supports.

# 1 Product introduction

## 1.1 Welcome!

Thank you for buying an ASUS® A8V-VM Ultra motherboard!

The motherboard delivers a host of new features and latest technologies, making it another standout in the long line of ASUS quality motherboards!

Before you start installing the motherboard, and hardware devices on it, check the items in your package with the list below.

## 1.2 Package contents

Check your motherboard package for the following items.

|                        |                                                                                                  |
|------------------------|--------------------------------------------------------------------------------------------------|
| <b>Motherboard</b>     | ASUS A8V-VM Ultra motherboard                                                                    |
| <b>Cables</b>          | 1 x floppy disk drive cable<br>1 x Ultra DMA 133/100/66 cable<br>1 x SATA cable kit (SATA/power) |
| <b>Accessories</b>     | I/O shield                                                                                       |
| <b>Application CDs</b> | ASUS motherboard support CD                                                                      |
| <b>Documentation</b>   | Quick Start Guide                                                                                |



If any of the above items is damaged or missing, contact your retailer.

## 1.3 Special features

### 1.3.1 Product highlights

#### AMD Dual-Core Architecture



The motherboard supports AMD dual-core processors containing two physical CPU cores with discrete L2 cache structure for each core to meet demands for more powerful computing.

#### Latest processor and 64-bit computing technology



The AMD Athlon™ 64, AMD Opteron™, and AMD Sempron™ desktop processors are based on AMD's 64-bit and 32-bit architecture, which represents the landmark introduction of the industry's first x86-64 technology. These processors provide a dramatic leap forward in compatibility, performance, investment protection, and reduced total cost of ownership and development. See page 1-8 for details.

#### Dual-channel DDR400 memory support



Employing the Double Date Rate (DDR) memory technology, the motherboard supports up to 2GB of system memory using DDR400/333/266 DIMMs. The ultra-fast 400MHz memory bus delivers the required bandwidth for the latest 3D graphics, multimedia, and Internet applications. See page 1-12 for details.

#### Serial ATA technology



The motherboard supports the Serial ATA technology through the Serial ATA interfaces. The SATA specification allows for thinner, more flexible cables with lower pin count, reduced voltage requirement, and up to 150 MB/s data transfer rate. See page 1-24 for details.

#### AMD Cool 'n' Quiet!™ Technology



The motherboard supports the AMD Cool 'n' Quiet!™ Technology that dynamically and automatically changes the CPU speed, voltage and amount of power depending on the task the CPU performs.

#### USB 2.0 technology



The motherboard implements the Universal Serial Bus (USB) 2.0 specification, dramatically increasing the connection speed from the 12 Mbps bandwidth on USB 1.1 to a fast 480 Mbps on USB 2.0. USB 2.0 is backward compatible with USB 1.1. See pages 1-20, 1-22, and 2-26 for details.

## PCI Express™ interface

The motherboard fully supports PCI Express, the latest I/O interconnect technology that speeds up the PCI bus. PCI Express features point-to-point serial interconnections between devices and allows higher clockspeeds by carrying data in packets. This high speed interface is software compatible with existing PCI specifications. See page 1-18 for details.

### 1.3.2 Innovative ASUS features

#### CrashFree BIOS 2

This feature allows you to restore the original BIOS data from the support CD in case when the BIOS codes and data are corrupted. This protection eliminates the need to buy a replacement ROM chip. See page 2-6 for details.

#### ASUS MyLogo™

This new feature present in the motherboard allows you to personalize and add style to your system with customizable boot logos. See page 2-33 for details.

#### ASUS EZ Flash BIOS

With the ASUS EZ Flash, you can easily update the system BIOS even before loading the operating system. No need to use a DOS-based utility or boot from a floppy disk. See page 2-3 for details.



## 1.4 Before you proceed

Take note of the following precautions before you install components into the system.



- Unplug the power cord from the wall socket before touching any component.
- Use a grounded wrist strap or touch a safely grounded object or a metal object, such as the power supply case, before handling components to avoid damaging them due to static electricity.
- Hold components by the edges to avoid touching the ICs on them.
- Whenever you uninstall any component, place it on a grounded antistatic pad or in the bag that came with the component.
- **Before you install or remove any component, ensure that the ATX power supply is switched off or the power cord is detached from the power supply.** Failure to do so may cause severe damage to the motherboard, peripherals, and/or components.

### Onboard LED

The motherboard comes with a green standby power LED. This LED lights up to indicate that the system is ON, in sleep mode or in soft-off mode, and not powered OFF. Unplug the power cable from the power outlet and make sure that the standby power LED is OFF before installing any system component.

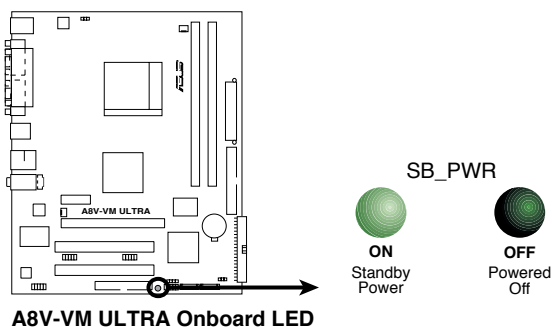

## 1.5 Motherboard overview

Before you install the motherboard, study the configuration of your chassis to ensure that the motherboard fits into it.



Make sure to unplug the power cord before installing or removing the motherboard. Failure to do so can cause you physical injury and damage motherboard components.

### 1.5.1 Placement direction

When installing the motherboard, make sure that you place it into the chassis in the correct orientation. The edge with external ports goes to the rear part of the chassis as indicated in the image below.

### 1.5.2 Screw holes

Place six (6) screws into the holes indicated by circles to secure the motherboard to the chassis.



Do not overtighten the screws! Doing so can damage the motherboard.

Place this side towards  
the rear of the chassis

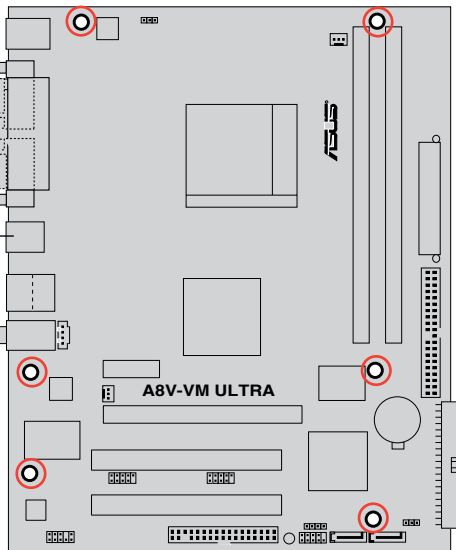

## 1.5.3 Motherboard layout

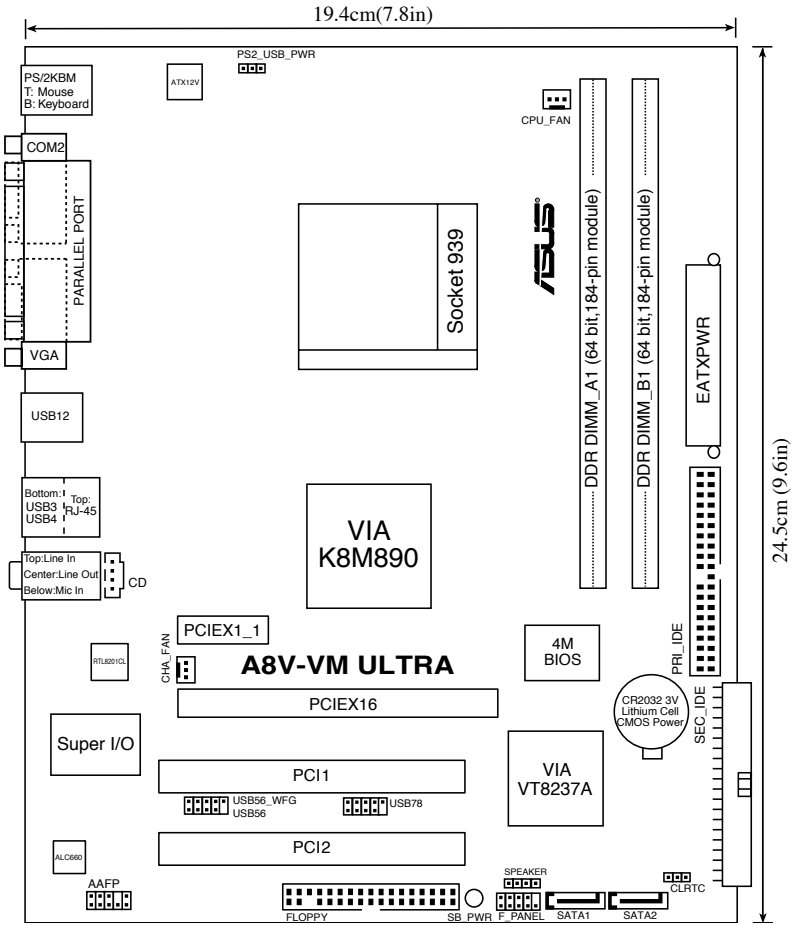

# 1.6 Central Processing Unit (CPU)

## 1.6.1 Overview

The motherboard comes with a surface mount 939-pin Zero Insertion Force (ZIF) socket designed for the AMD Athlon™ 64, AMD Sempron™, or AMD Opteron™ processors.

The 128-bit-wide data paths of these processors can run applications faster than processors with only 32-bit or 64-bit wide data paths.

Take note of the marked corner (with gold triangle) on the CPU. This mark should match a specific corner on the socket to ensure correct installation.

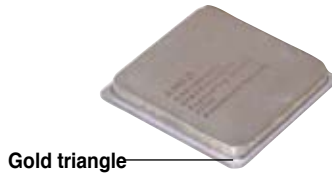

## 1.6.2 Installing the CPU

To install a CPU:

1. Locate the CPU socket on the motherboard.

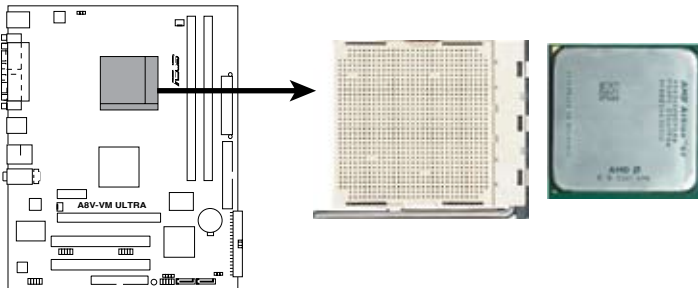

**A8V-VM ULTRA CPU Socket 939**



Before installing the CPU, make sure that the socket box is facing towards you and the load lever is on your left.

2. Unlock the socket by pressing the lever sideways, then lift it up to a 90°-100° angle.



Make sure that the socket lever is lifted up to 90°-100° angle, otherwise the CPU does not fit in completely.

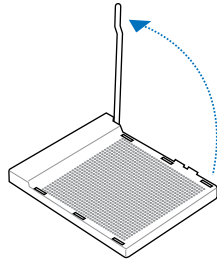

3. Position the CPU above the socket such that the CPU corner with the gold triangle matches the socket corner with a small triangle.
4. Carefully insert the CPU into the socket until it fits in place.

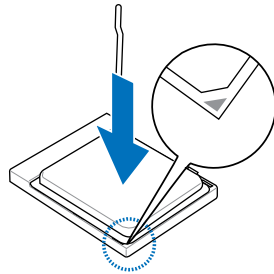

The CPU fits only in one correct orientation. **DO NOT** force the CPU into the socket to prevent bending the pins and damaging the CPU!

5. When the CPU is in place, push down the socket lever to secure the CPU. The lever clicks on the side tab to indicate that it is locked.

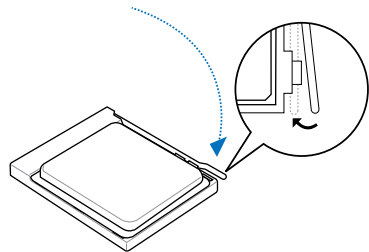

### 1.6.3 Installing the heatsink and fan

The AMD Athlon™ 64, AMD Sempron™, or AMD Opteron™ processor requires a specially designed heatsink and fan assembly to ensure optimum thermal condition and performance.

Follow these steps to install the CPU heatsink and fan.

1. Place the heatsink on top of the installed CPU, making sure that the heatsink fits properly on the retention module base.



- 
- The retention module base is already installed on the motherboard upon purchase.
  - You do not have to remove the retention module base when installing the CPU or installing other motherboard components.
  - If you purchased a separate CPU heatsink and fan assembly, make sure that a Thermal Interface Material is properly applied to the CPU heatsink or CPU before you install the heatsink and fan assembly.
- 

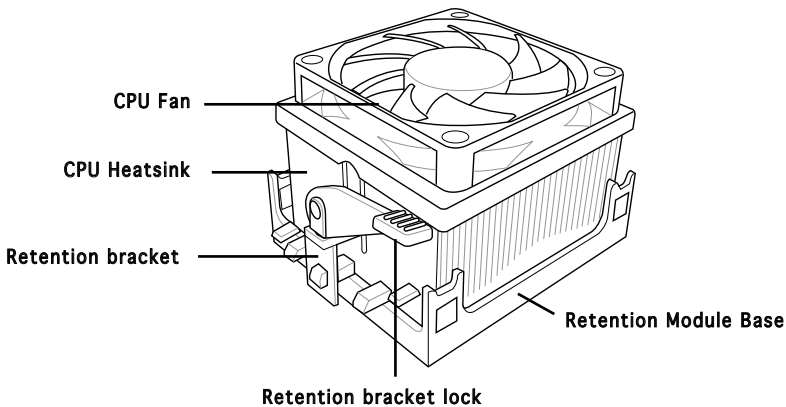

---

Your boxed CPU heatsink and fan assembly should come with installation instructions for the CPU, heatsink, and the retention mechanism. If the instructions in this section do not match the CPU documentation, follow the latter.

---

2. Attach one end of the retention bracket to the retention module base.

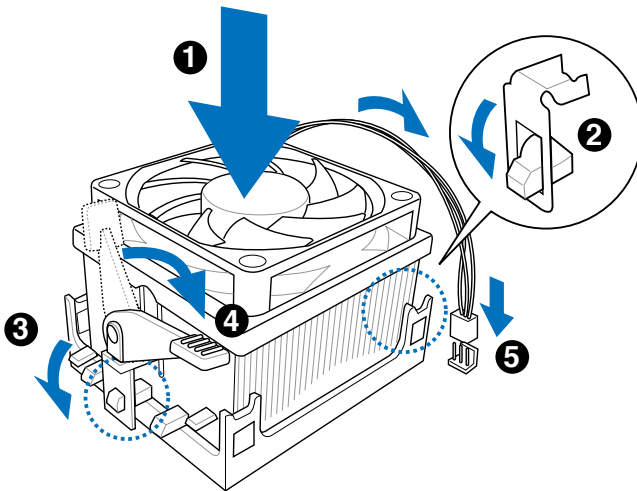

3. Align the other end of the retention bracket (near the retention bracket lock) to the retention module base. A clicking sound denotes that the retention bracket is in place.



Make sure that the fan and heatsink assembly perfectly fits the retention mechanism module base, otherwise you cannot snap the retention bracket in place.

4. Push down the retention bracket lock on the retention mechanism to secure the heatsink and fan to the module base.
5. When the fan and heatsink assembly is in place, connect the CPU fan cable to the connector on the motherboard labeled CPU\_FAN.

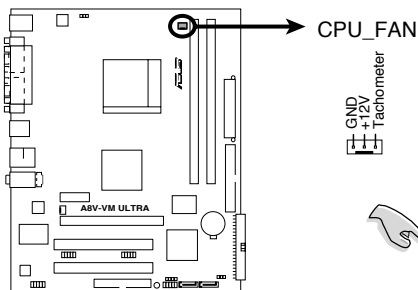

**A8V-VM ULTRA CPU Fan Connector**



Do not forget to connect the CPU fan connector! Hardware monitoring errors can occur if you fail to plug this connector.

## 1.7 System memory

### 1.7.1 Overview

The motherboard comes with two 184-pin Double Data Rate (DDR) Dual Inline Memory Module (DIMM) sockets.

The following figure illustrates the location of the sockets:

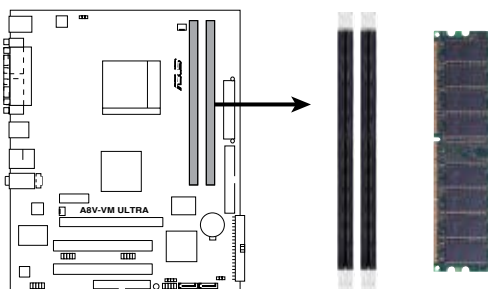

**A8V-VM ULTRA 184-pin DDR DIMM Sockets**

| Channel   | Sockets |
|-----------|---------|
| Channel A | DIMM_A1 |
| Channel B | DIMM_B1 |

### 1.7.2 Memory configurations

You may install 64MB, 128 MB, 256 MB, 512 MB, 2 GB unbuffered ECC or non-ECC DDR DIMMs into the DIMM sockets using the memory configuration in this section.



- For dual-channel configuration, the size of memory module installed per channel must be the same (DIMM\_A1= DIMM\_B1)
- Always install DIMMs with the same CAS latency. For optimum compatibility, it is recommended that you obtain memory modules from the same vendor. See the Qualified Vendors List (QVL) on the next page.
- If you are installing only one DIMM module for a Single-channel configuration, install the module on DIMM\_B1.



# DDR400 Qualified Vendors List

| Size  | Vendor    | Model                | Brand        | Side(s) | Component         | DIMM support |   |
|-------|-----------|----------------------|--------------|---------|-------------------|--------------|---|
|       |           |                      |              |         |                   | A            | B |
| 256MB | Kingston  | KVR333X64C25/256     | Kingston     | SS      | D3208DH1T-6       | •            | • |
| 256MB | Kingston  | KVR333X64C25/256     | Hynix        | SS      | HY5DU56822BT-J    | •            | • |
| 256MB | Kingston  | KVR333X64C25/256     | Hynix        | DS      | HY5DU56822BT-D43  | •            | • |
| 512MB | Kingston  | KVR333X64C25/512     | Kingston     | DS      | D3208DH1T-6       | •            | • |
| 512MB | Kingston  | KVR400X64C3A/512     | Hynix        | DS      | HY5DU56822BT-D43  | •            | • |
| 512MB | Kingston  | KVR400X64C3A/512     | Kingston     | DS      | D3208DH1T-5       | •            | • |
| 512MB | Kingston  | KVR400X64C3A/512     | Hynix        | SS      | HY5DU12822BT-D43  | •            | • |
| 256MB | Kingston  | KVR400X64C3A/256     | Hynix        | SS      | HY5DU56822BT-D43  | •            | • |
| 256MB | Kingston  | KVR400X64C3A/256     | Kingston     | SS      | D3208DL3T-5A      | •            | • |
| 256MB | Kingston  | KVR400X64C3A/256     | PSC          | SS      | A2S56D30BTP       | •            | • |
| 1G    | Kingston  | KVR400X64C3A/1G      | Infineon     | DS      | HYB25D512800BE-5B | •            | • |
| 256MB | Infineon  | HY564D32300HU-5-C    | Infineon     | SS      | HYB25D256800CE-5C | •            | • |
| 512MB | Infineon  | HY564D64320HU-5-C    | Infineon     | DS      | HYB25D256800CE-5C | •            | • |
| 512MB | Infineon  | HY564D64300HU-5-B    | Infineon     | SS      | HYB25D512800BE-5B | •            | • |
| 256MB | Infineon  | HY564D32300GU-5-C    | Infineon     | SS      | HYB25D256800CE-5C | •            | • |
| 512MB | Infineon  | HY564D64320HU-6-C    | Infineon     | DS      | HYB25D256800CE-6C | •            | • |
| 256MB | HY        | HYMD232646D8J-D43    | Hynix        | SS      | HY5DU56822BT-D43  | •            | • |
| 512MB | HY        | HYMD264646D8J-D43    | Hynix        | DS      | HY5DU56822BT-D43  | •            | • |
| 256MB | HY        | HYMD232646B8J-J      | Hynix        | SS      | HY5DU56822BT-J    | •            | • |
| 512MB | HY        | HYMD264646B8J-J      | Hynix        | DS      | HY5DU56822BT-J    | •            | • |
| 256MB | Corsair   | V5256MB400           | Value select | SS      | V532MB-5 2B0409   | •            | • |
| 256MB | Corsair   | XMS3202v3.1          | Infineon     | DS      | HYB25D256807BT-5B | •            | • |
| 512MB | Corsair   | XMS3205v1.2          | Winbond      | DS      | W942508CH-5       | •            | • |
| 512MB | Corsair   | V5512MB400           | Value select | DS      | V532MB-5 2B0402   | •            | • |
| 256MB | Corsair   | XMS2700v1.1          | Winbond      | SS      | W942508BH-6       | •            | • |
| 256MB | Corsair   | V5256MB333           | Samsung      | SS      | K4H560838D-TCB3   | •            | • |
| 512MB | Corsair   | XMS2702v3.1          | Mosel        | DS      | V58C2256804SAT6   | •            | • |
| 512MB | Corsair   | XMS2702v1.2          | Winbond      | DS      | W942508CH-6       | •            | • |
| 512MB | Micron    | MT16VDDT6464AG-335GB | Micron       | DS      | MT46V32M8TG-6TG   | •            | • |
| 256MB | Micron    | MT8VDDT3264AG-335GB  | Micron       | SS      | MT46V32M8TG-6TG   | •            | • |
| 256MB | Micron    | MT8VDDT3264AG-40GBG  | Micron       | SS      | MT46V32M8TG-5BG   | •            | • |
| 512MB | Micron    | MT16VDDT6464AG-40BCB | Micron       | DS      | MT46V32M8TG-5BC   | •            | • |
| 256MB | Samsung   | M368L3223FTN-CCC     | Samsung      | SS      | K4H560838F-TCCC   | •            | • |
| 512MB | Samsung   | M368L6423FTN-CCC     | Samsung      | DS      | K4H560838F-TCCC   | •            | • |
| 256MB | Samsung   | M368L3223FTN-CB3     | Samsung      | SS      | K4H560838F-TCB3   | •            | • |
| 512MB | Samsung   | M368L6423FTN-CB3     | Samsung      | DS      | K4H560838F-TCB3   | •            | • |
| 256MB | Elpida    | U24256ADEPG6H20      | Elpida       | SS      | DD2508AKTA-5C     | •            | • |
| 512MB | Elpida    | U24512ADEPG6H20      | Elpida       | DS      | DD2508AMTA        | •            | • |
| 512MB | Apacer    | 77.90728.U1G         | Apacer       | DS      | AM3A568AJT-6B     | •            | • |
| 256MB | Apacer    | 77.10636.46G         | Samsung      | SS      | K4H560838E-TCCC   | •            | • |
| 256MB | Apacer    | 77.10636.56G         | Mosel        | SS      | V58C2256804SAT5B  | •            | • |
| 512MB | Apacer    | 77.10736.11G         | Infineon     | DS      | HYB25D256800BT-5B | •            | • |
| 256MB | Transcend | DDR400-256           | Samsung      | SS      | K4H560838F-TCCC   | •            | • |
| 256MB | Transcend | DDR400-256           | Mosel        | SS      | V58C2256804SAT5B  | •            | • |
| 256MB | Transcend | 103004-0720          | PSC          | SS      | A2S56D30BTP       | •            | • |
| 512MB | Transcend | 102709-0001          | PSC          | DS      | A2S56D30ATP       | •            | • |
| 512MB | Transcend | DDR400-512           | Mosel        | DS      | V58C2256804SAT5B  | •            | • |
| 512MB | Transcend | DDR400-512           | Samsung      | DS      | K4H560838F-TCCC   | •            | • |
| 256MB | Transcend | 111448-0214          | 2.5          | PSC     | SS A2S56D30BTP    | •            | • |
| 512MB | Transcend | DDR333-512           | Hynix        | DS      | HY5DU56822CT-J    | •            | • |
| 256MB | Kingmax   | MPMB62D-38LT3R       | Mosel        | SS      | V58C2256804SAT6   | •            | • |
| 512MB | Kingmax   | MPMC22D-38HT3R       | Hynix        | DS      | HY5DU56822BT-J    | •            | • |
| 256MB | Kingmax   | MPXB62D-38KT3R       | Kingmax      | SS      | KDL388P4LA-50     | •            | • |
| 512MB | Kingmax   | MPXC22D-38KT3R       | Kingmax      | DS      | KDL388P4EA-50     | •            | • |
| 256MB | Vdata     | MDYVDF64G2880B1E0H   | Vdata        | SS      | VDD9616A8A-5C     | •            | • |
| 256MB | Pmi       | 3208GATA07-0A47      | Pmi          | SS      | PM4D32850406UE    | •            | • |
| 512MB | Pmi       | 3208GATA01-0A44      | Pmi          | DS      | PM4D32850403DU    | •            | • |

(Continued on the next page)

## DDR400 Qualified Vendors List

| Size  | Vendor   | Model              | Brand    | Side(s) | Component         | DIMM support |   |
|-------|----------|--------------------|----------|---------|-------------------|--------------|---|
|       |          |                    |          |         |                   | A            | B |
| 256MB | Mosel    | V826632K24SATG-D3  | Mosel    | SS      | V58C2256804SAT5   | •            | • |
| 512MB | Mosel    | V826664K24SATG-D3  | Mosel    | DS      | V58C2256804SAT5   | •            | • |
| 256MB | Nanya    | NT256D64S88B1G-5T  | Nanya    | SS      | NT5DS32M8BT-5T    | •            | • |
| 512MB | Nanya    | NT512D64S88B1G-5T  | Nanya    | DS      | NT5DS32M8BT-5T    | •            | • |
| 512MB | Nanya    | NT512D64S88COGY-5T | Nanya    | SS      | NT5DS64M8CS-5T    | •            | • |
| 1G    | Nanya    | NT1GD64S88COGY-5T  | Nanya    | DS      | NT5DS64M8CS-5T    | •            | • |
| 256MB | Smart    | U24256ADSRG6H20    | Smart    | SS      | D32M8XS50H3X4AMV  | •            | • |
| 256MB | Smart    | U24256ADSRG6H20    | Smart    | SS      | D32M8XS60HBX4AMV  | •            | • |
| 512MB | Smart    | U24512ADSRG6H20    | Smart    | DS      | D32M8XS50H3X4AMV  | •            | • |
| 512MB | Smart    | U24512ADSRG6H20    | Smart    | DS      | D32M8XS60HBX4AMV  | •            | • |
| 256MB | Twinmos  | DDR333-256         | Twinmos  | SS      | TMD7608F8E60B     | •            | • |
| 256MB | Twinmos  | M2G9108A-TT        | Twinmos  | SS      | TMD7608F8E501     | •            | • |
| 256MB | Promos   | V826632K24SCTG-D0  | Promos   | SS      | V58C2256804SCT5B  | •            | • |
| 512MB | Promos   | V826664K24SCTG-D0  | Promos   | DS      | V58C2256804SCT5B  | •            | • |
| 512MB | BiaoXing | BXXC22D-38KT3B     | BiaoXing | DS      | VM256D328BT-5     | •            | • |
| 256MB | Winbond  | U24256ADWBG6H20    | Winbond  | SS      | W942508CH-5       | •            | • |
| 256MB | Winbond  | U24256AAWBG6H20    | Winbond  | SS      | W942508CH-6       | •            | • |
| 512MB | Winbond  | DDR333-512         | Winbond  | DS      | W942508BH-6       | •            | • |
| 512MB | Winbond  | U24512ADWBG6H20    | Winbond  | DS      | W942508CH-5       | •            | • |
| 512MB | Patriot  | PDC1G3200+XBLK     | Patriot  | DS      |                   | •            | • |
| 512MB | MDT      | MDT 512MB          | MDT      | DS      | MDT25B25680-50S30 | •            | • |
| 512MB | GELIL    | GE5123200          | GELIL    | DS      | GL3LC32G88T-5A    | •            | • |

**Side(s):** SS - Single-Sided

DS - Double-Sided

### DIMM Support:

- A -** supports one module as a single-channel memory configuration.
- B -** supports one pair of modules inserted into two slots as one pair of dual-channel memory configuration.



Visit the ASUS website ([www.asus.com](http://www.asus.com)) for the latest DDR 400 Qualified Vendors List.

## 1.7.3 Installing a DIMM



Make sure to unplug the power supply before adding or removing DIMMs or other system components. Failure to do so may cause severe damage to both the motherboard and the components.

1. Unlock a DIMM socket by pressing the retaining clips outward.
2. Align a DIMM on the socket such that the notch on the DIMM matches the break on socket.

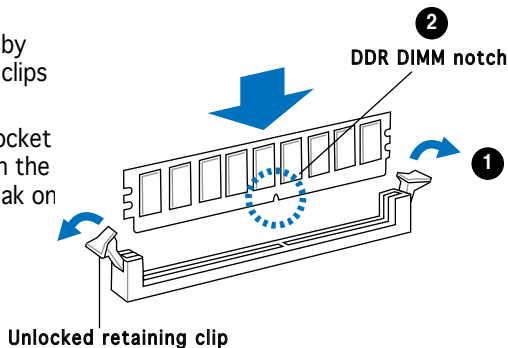

A DDR DIMM is keyed with a notch so that it fits in only one direction. DO NOT force a DIMM into a socket to avoid damaging the DIMM.

3. Firmly insert the DIMM into the socket until the retaining clips snap back in place and the DIMM is properly seated.

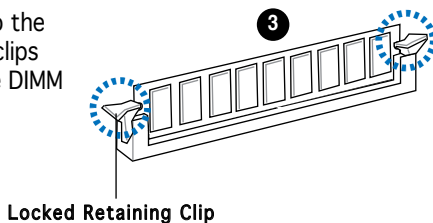

## 1.7.4 Removing a DIMM

Follow these steps to remove a DIMM.

1. Simultaneously press the retaining clips outward to unlock the DIMM.

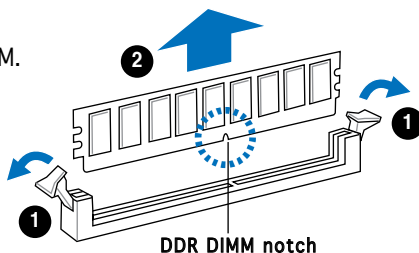

Support the DIMM lightly with your fingers when pressing the retaining clips. The DIMM might get damaged when it flips out with extra force.

2. Remove the DIMM from the socket.

## 1.8 Expansion slots

In the future, you may need to install expansion cards. The following sub-sections describe the slots and the expansion cards that they support.



---

Make sure to unplug the power cord before adding or removing expansion cards. Failure to do so may cause you physical injury and damage motherboard components.

---

### 1.8.1 Installing an expansion card

To install an expansion card:

1. Before installing the expansion card, read the documentation that came with it and make the necessary hardware settings for the card.
2. Remove the system unit cover (if your motherboard is already installed in a chassis).
3. Remove the bracket opposite the slot that you intend to use. Keep the screw for later use.
4. Align the card connector with the slot and press firmly until the card is completely seated on the slot.
5. Secure the card to the chassis with the screw you removed earlier.
6. Replace the system cover.

### 1.8.2 Configuring an expansion card

After installing the expansion card, configure it by adjusting the software settings.

1. Turn on the system and change the necessary BIOS settings, if any. See Chapter 2 for information on BIOS setup.
2. Assign an IRQ to the card. Refer to the tables on the next page.
3. Install the software drivers for the expansion card.

## Standard interrupt assignments

| IRQ | Priority | Standard Function            |
|-----|----------|------------------------------|
| 0   | 1        | System Timer                 |
| 1   | 2        | Keyboard Controller          |
| 2   | -        | Programmable interrupt       |
| 3   | 11       | Communications Port (COM2)*  |
| 4   | 12       | -                            |
| 5   | 13       | IRQ holder for PCI steering* |
| 6   | 14       | Floppy Disk Controller       |
| 7   | 15       | Printer Port (LPT1)*         |
| 8   | 3        | System CMOS/Real Time Clock  |
| 9   | 4        | IRQ holder for PCI steering* |
| 10  | 5        | MIDI port*                   |
| 11  | 6        | IRQ holder for PCI steering* |
| 12  | 7        | PS/2 Compatible Mouse Port*  |
| 13  | 8        | Numeric Data Processor       |
| 14  | 9        | Primary IDE Channel          |
| 15  | 10       | Secondary IDE Channel        |

\* These IRQs are usually available for ISA or PCI devices.

## IRQ assignments for this motherboard

|                          | A      | B      | C      | D      | E | F | G | H      |
|--------------------------|--------|--------|--------|--------|---|---|---|--------|
| PCI slot 1               | shared | —      | —      | —      | — | — | — | —      |
| PCI slot 2               | —      | shared | —      | —      | — | — | — | —      |
| PCI Express x16 slot     | —      | —      | —      | —      | — | — | — | shared |
| PCI Express x1 slot 1    | —      | —      | —      | —      | — | — | — | shared |
| Onboard USB controller 0 | shared | —      | —      | —      | — | — | — | —      |
| Onboard USB controller 1 | —      | shared | —      | —      | — | — | — | —      |
| Onboard USB controller 2 | —      | —      | shared | —      | — | — | — | —      |
| Onboard USB controller 3 | —      | —      | —      | shared | — | — | — | —      |
| Onboard EHCI controller  | —      | —      | shared | —      | — | — | — | —      |
| Onboard SATA Controller  | —      | shared | —      | —      | — | — | — | —      |
| Onboard Audio Controller | —      | shared | —      | —      | — | — | — | —      |
| Onboard LAN              | shared | —      | —      | —      | — | — | — | —      |
| Integrated graphics      | shared | —      | —      | —      | — | — | — | —      |



When using PCI cards on shared slots, ensure that the drivers support “Share IRQ” or that the cards do not need IRQ assignments; otherwise, conflicts will arise between the two PCI groups, making the system unstable and the card inoperable.

### 1.8.3 PCI Express x1 slot

This motherboard supports PCI Express x1 network cards, SCSI cards and other cards that comply with the PCI Express specifications. The figure shows a network card installed on the PCI Express x1 slot.



### 1.8.4 PCI slots

The PCI slots support cards such as a LAN card, SCSI card, USB card, and other cards that comply with PCI specifications. The figure shows a LAN card installed on a PCI slot.

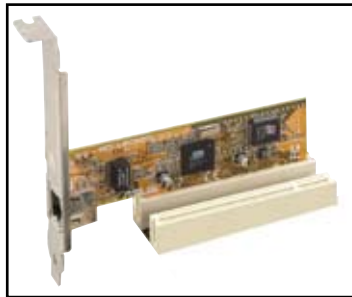

### 1.8.5 PCI Express x16 slot

This motherboard supports PCI Express x16 graphic cards that comply with the PCI Express specifications. The figure shows a graphics card installed on the PCI Express x16 slot.



## 1.9 Jumpers

### 1. Clear RTC RAM (CLRTC)

This jumper allows you to clear the Real Time Clock (RTC) RAM in CMOS. You can clear the CMOS memory of date, time, and system setup parameters by erasing the CMOS RTC RAM data. The onboard button cell battery powers the RAM data in the CMOS, which includes the system setup information such as system passwords.

To erase the RTC RAM:

1. Turn OFF the computer and unplug the power cord.
2. Remove the battery.
3. Move the jumper cap from pins 1-2 (default) to pins 2-3. Keep the cap on pins 2-3 for about 5-10 seconds, then move the cap back to pins 1-2.
4. Re-install the battery.
5. Plug the power cord and turn ON the computer.
6. Hold down the <Del> key during the boot process and enter BIOS setup to re-enter data.

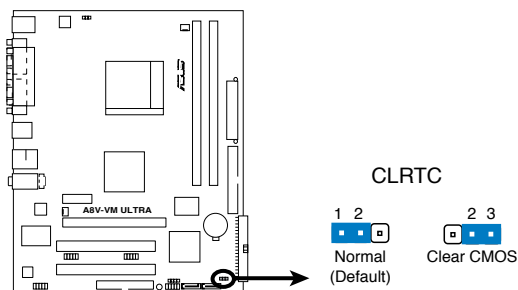

**A8V-VM ULTRA Clear RTC RAM**



Except when clearing the RTC RAM, never remove the cap on CLRTC jumper default position. Removing the cap will cause system boot failure.

## 2. USB device wake-up (3-pin PS2\_USB\_PWR)

Set this jumper to +5V to wake up the computer from S1 sleep mode (CPU stopped, DRAM refreshed, system running in low power mode) using the connected USB devices. Set to +5VSB to wake up from S3 and S4 sleep modes (no power to CPU, DRAM in slow refresh, power supply in reduced power mode).

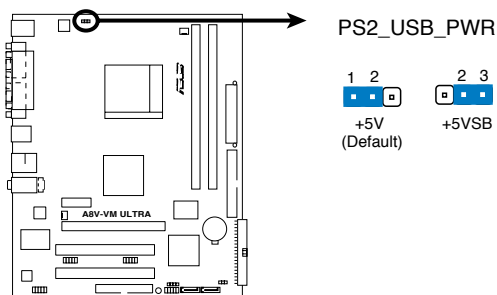

### A8V-VM ULTRA USB Device Wake Up



- The USB device wake-up feature requires a power supply that can provide 500mA on the +5VSB lead for each USB port; otherwise, the system would not power up.
- The total current consumed must NOT exceed the power supply capability (+5VSB) whether under normal condition or in sleep mode.



# 1.10 Connectors

## 1.10.1 Rear panel connectors

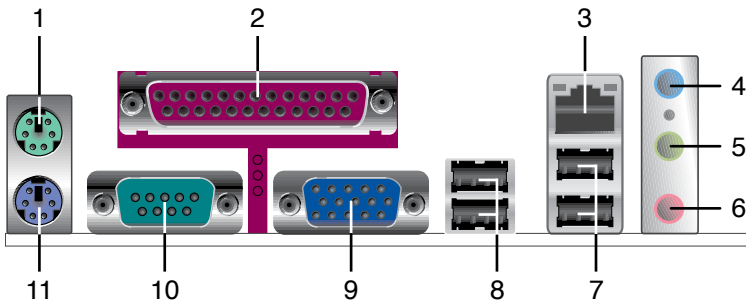

1. **PS/2 mouse port (green).** This port is for a PS/2 mouse.
2. **Parallel port.** This 25-pin port connects a parallel printer, a scanner, or other devices.
3. **LAN (RJ-45) port.** This port allows Gigabit connection with a speed of 100 Mbps to a Local Area Network (LAN) through a network hub. Refer to the table below for the LAN port LED indications.

### LAN port LED indications

| 100 Mbps LED |                            | 10 Mbps LED |                            |
|--------------|----------------------------|-------------|----------------------------|
| Status       | Description                | Status      | Description                |
| OFF          | No link                    | OFF         | No link                    |
| Orange       | 100 Mbps connection        | GREEN       | 10 Mbps connection         |
| BLINKING     | Transmitting and receiving | BLINKING    | Transmitting and receiving |

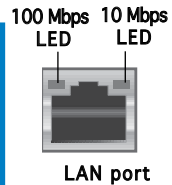

4. **Line In port (light blue).** This port connects a tape, CD, DVD player, or other audio sources.
5. **Line Out port (lime).** This port connects a headphone or a speaker. In 4-channel and 6-channel configuration, the function of this port becomes Front Speaker Out.
6. **Microphone port (pink).** This port connects a microphone.



Refer to the audio configuration table below for the function of the audio ports in 2, 4, or 6-channel configuration.

### Audio 2, 4, or 6-channel configuration

| Port       | 2-channel | 4-channel         | 6-channel         |
|------------|-----------|-------------------|-------------------|
| Light Blue | Line In   | Back Surround     | Back Surround     |
| Lime       | Line Out  | Front Speaker Out | Front Speaker Out |
| Pink       | Mic In    | Mic In            | Center/LFE        |

- 7. USB 2.0 ports 3 and 4.** These two 4-pin Universal Serial Bus (USB) ports are available for connecting USB 2.0 devices.
- 8. USB 2.0 ports 1 and 2.** These two 4-pin Universal Serial Bus (USB) ports are available for connecting USB 2.0 devices.
- 9. VGA port.** This 15-pin VGA port connects to a VGA monitor.
- 10. Serial port.** This port connects a mouse, modem, or other devices that conform with serial specification.
- 11. PS/2 keyboard port (purple).** This port is for a PS/2 keyboard.

## 1.10.2 Internal connectors

### 1. Floppy disk drive connector (34-1 pin FLOPPY)

This connector is for the provided floppy disk drive (FDD) signal cable. Insert one end of the cable to this connector, then connect the other end to the signal connector at the back of the floppy disk drive.



Pin 5 on the connector is removed to prevent incorrect cable connection when using a FDD cable with a covered Pin 5.

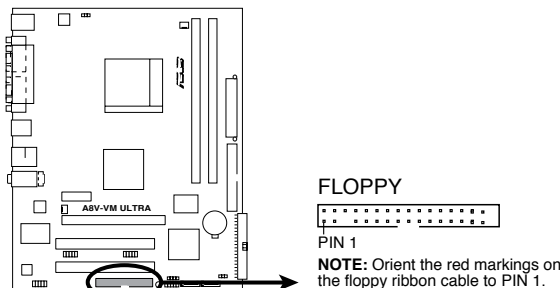

**A8V-VM ULTRA Floppy Disk Drive Connector**

## 2. IDE connectors (40-1 pin PRI\_IDE, SEC\_IDE)

The onboard IDE connectors are for Ultra DMA 133/100/66 signal cables. There are three connectors on each Ultra DMA 133/100/66 signal cable: blue, black, and gray. Connect the blue connector to the motherboard's IDE connector, then select one of the following modes to configure your device(s).

|               | Drive jumper setting   | Mode of device(s) | Cable connector |
|---------------|------------------------|-------------------|-----------------|
| Single device | Cable-Select or Master | -                 | Black           |
| Two devices   | Cable-Select           | Master<br>Slave   | Black<br>Gray   |
|               | Master<br>Slave        | Master<br>Slave   | Black or gray   |



- Pin 20 on the IDE connector is removed to match the covered hole on the Ultra DMA cable connector. This prevents incorrect insertion when you connect the IDE cable.
- Use the 80-conductor IDE cable for Ultra DMA 133/100/66 IDE devices.



If any device jumper is set as "Cable-Select," make sure all other device jumpers have the same setting.

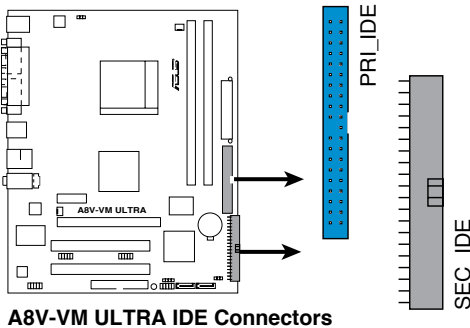

### 3. Serial ATA connectors (7-pin SATA1, SATA2)

These connectors support the thin Serial ATA cables for Serial ATA hard disks. If you installed Serial ATA hard disks, you may create a RAID 0, RAID 1, or JBOD configuration.

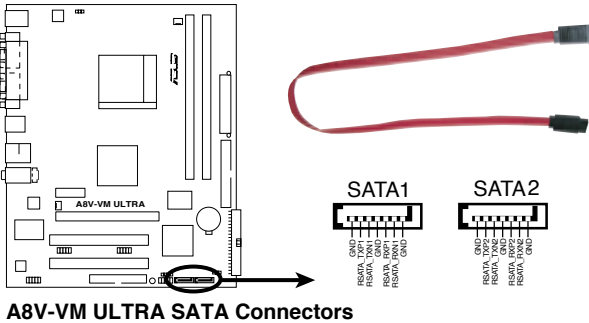

Install the Windows® 2000 Service Pack 4 or the Windows® XP Service Pack1 before using Serial ATA.



For detailed instructions on how to configure RAID 0, RAID1, and JBOD, refer to the RAID manual in the support CD.

### 4. Speaker out connector (4-pin SPEAKER)

This connector is for the case-mounted speaker and allows you to hear system beeps and warnings.

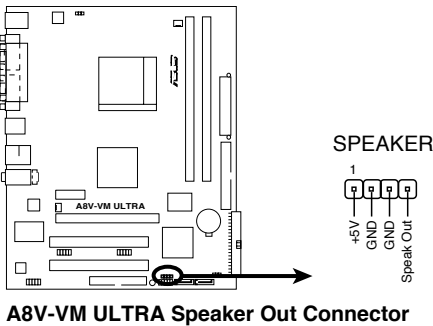

## 5. CPU and Chassis fan connectors (3-pin CPU\_FAN, CHA\_FAN)

The fan connectors support cooling fans of 350 mA~740 mA (8.88 W max.) or a total of 1 A~2.22 A (26.64 W max.) at +12V. Connect the fan cables to the fan connectors on the motherboard, making sure that the black wire of each cable matches the ground pin of the connector.



Do not forget to connect the fan cables to the fan connectors. Insufficient air flow inside the system may damage the motherboard components. These are not jumpers! Do not place jumper caps on the fan connectors!

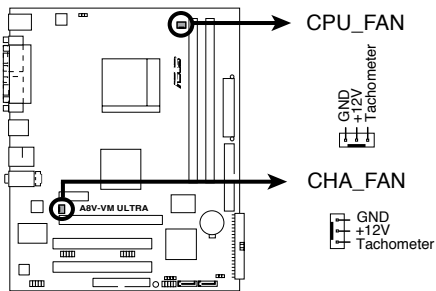

**A8V-VM ULTRA Fan Connectors**

## 6. USB connectors (10-1 pin USB56, USB78)

These connectors are for USB 2.0 ports. Connect the USB module cable to any of these connectors, then install the module to a slot opening at the back of the system chassis. These USB connectors comply with USB 2.0 specification that supports up to 480 Mbps connection speed.

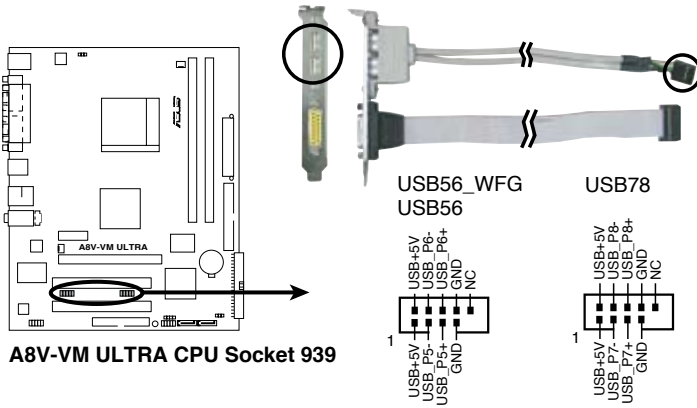

Never connect a 1394 cable to the USB connectors. Doing so will damage the motherboard!



The USB2.0 module is purchased separately .

## 7. ATX power connectors (24-pin EATXPWR, 4-pin ATX12V)

These connectors are for ATX power supply plugs. The plugs from the power supply are designed to fit these connectors in only one orientation. Find the proper orientation and push down firmly until the connectors completely fit.

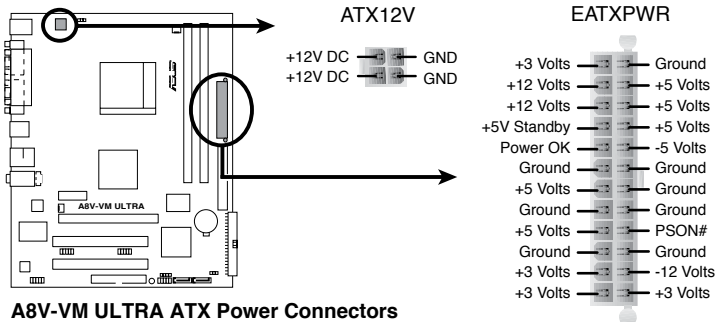

**A8V-VM ULTRA ATX Power Connectors**



- We recommend that you use an ATX 12 V Specification 2.0-compliant power supply unit (PSU) with a minimum of 300 W power rating. This PSU type has 24-pin and 4-pin power plugs.
- If you intend to use a PSU with 20-pin and 4-pin power plugs, make sure that the 20-pin power plug can provide at least 15 A on +12 V and that the PSU has a minimum power rating of 300 W. The system may become unstable or may not boot up if the power is inadequate.
- Do not forget to connect the 4-pin ATX +12 V power plug; otherwise, the system will not boot up.
- We recommend that you use a PSU with higher power output when configuring a system with more power-consuming devices. The system may become unstable or may not boot up if the power is inadequate.
- You must install a PSU with a higher power rating if you intend to install additional devices.

## 8. Internal audio connector (4-pin CD)

This connector is for the 4-pin audio cable that connects to the audio connector at the back of the optical drive.

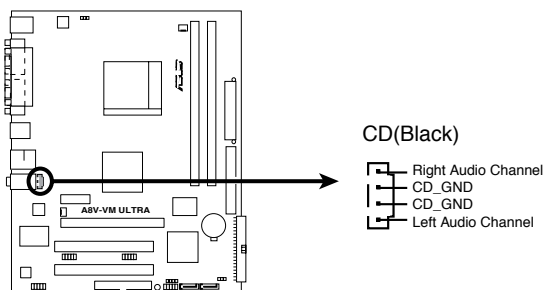

**A8V-VM ULTRA Internal audio connector**

## 9. Front panel audio connector (10-1 pin FP\_AUDIO)

This connector is for a chassis-mounted front panel audio I/O module that supports High Definition Audio. Connect one end of the front panel audio I/O module cable to this connector.

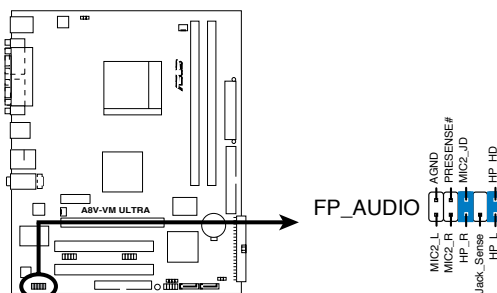

**A8V-VM ULTRA Front Panel Audio Connector**



- We recommend that you connect a high-definition front panel audio module to this connector to avail of the motherboard high-definition audio capability.
- If you want to connect a high-definition front panel audio module to this connector, make sure the **High Definition Audio** item in the BIOS is set to [Auto]. See page 2-24 for details.



## 10. System panel connector (10-1 pin F\_PANEL)

This connector supports several system chassis-mounted functions.

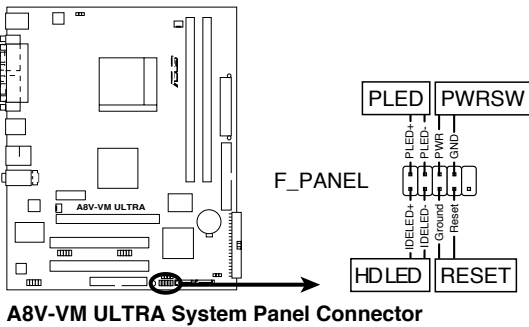

The system panel connector is color-coded for easy connection. Refer to the connector description below for details.

- **System power LED (Green 2-pin PLED)**  
This 2-pin connector is for the system power LED. Connect the chassis power LED cable to this connector. The system power LED lights up when you turn on the system power, and blinks when the system is in sleep mode.
- **Hard disk drive activity (Red 2-pin HD\_LED)**  
This 2-pin connector is for the HDD Activity LED. Connect the HDD Activity LED cable to this connector. The IDE LED lights up or flashes when data is read from or written to the HDD.
- **Power/Soft-off button (Yellow 2-pin PWRSW)**  
This connector is for the system power button. Pressing the power button turns the system ON or puts the system in SLEEP or SOFT-OFF mode depending on the BIOS settings. Pressing the power switch for more than four seconds while the system is ON turns the system OFF.
- **Reset button (Blue 2-pin RESET)**  
This 2-pin connector is for the chassis-mounted reset button for system reboot without turning off the system power.



This chapter tells how to change the system settings through the BIOS Setup menus. Detailed descriptions of the BIOS parameters are also provided.

# BIOS setup **2**

## 2.1 Managing and updating your BIOS

The following utilities allow you to manage and update the motherboard Basic Input/Output System (BIOS) setup.

1. **ASUS EZ Flash** (Updates the BIOS using a floppy disk during POST.)
2. **ASUS AFUDOS** (Updates the BIOS in DOS mode using a bootable floppy disk.)
3. **ASUS CrashFree BIOS 2** (Updates the BIOS using a bootable floppy disk or the motherboard support CD when the BIOS file fails or gets corrupted.)
4. **ASUS Update** (Updates the BIOS in Windows® environment.)

Refer to the corresponding sections for details on these utilities.



---

Save a copy of the original motherboard BIOS file to a bootable floppy disk in case you need to restore the BIOS in the future. Copy the original motherboard BIOS using the ASUS Update or AFUDOS utilities.

---

### 2.1.1 Creating a bootable floppy disk

1. Do either one of the following to create a bootable floppy disk.
  - DOS environment
    - a. Insert a 1.44MB floppy disk into the drive.
    - b. At the DOS prompt, type `format a: /s` then press <Enter>.
  - Windows® XP environment
    - a. Insert a 1.44 MB floppy disk to the floppy disk drive.
    - b. Click **Start** from the Windows® desktop, then select **My Computer**.
    - c. Select the 3 1/2 Floppy Drive icon.
    - d. Click **File** from the menu, then select **Format**. A **Format 3 1/2 Floppy Disk** window appears.
    - e. Select **Create an MS-DOS startup disk** from the format options field, then click **Start**.
  - Windows® 2000 environment

To create a set of boot disks for Windows® 2000:

- a. Insert a formatted, high density 1.44 MB floppy disk into the drive.
- b. Insert the Windows® 2000 CD to the optical drive.
- c. Click **Start**, then select **Run**.

- d. From the Open field, type  
**D:\bootdisk\makeboot a:**  
assuming that D: is your optical drive.
  - e. Press <Enter>, then follow screen instructions to continue.
2. Copy the original or the latest motherboard BIOS file to the bootable floppy disk.

## 2.1.2 ASUS EZ Flash utility

The ASUS EZ Flash feature allows you to update the BIOS without having to go through the long process of booting from a floppy disk and using a DOS-based utility. The EZ Flash utility is built-in the BIOS chip so it is accessible by pressing <Alt> + <F2> during the Power-On Self Tests (POST).

To update the BIOS using EZ Flash:

1. Visit the ASUS website ([www.asus.com](http://www.asus.com)) to download the latest BIOS file for the motherboard and rename the same to **A8VVMUT.ROM**.
2. Save the BIOS file to a floppy disk, then restart the system.
3. Press <Alt> + <F2> during POST to display the following.

```
EZFlash starting BIOS update
Checking for floppy...
```

4. Insert the floppy disk that contains the BIOS file to the floppy disk drive. When the correct BIOS file is found, EZ Flash performs the BIOS update process and automatically reboots the system when done.

```
EZFlash starting BIOS update
Checking for floppy...
Floppy found!
Reading file "A8VVMUT.ROM". Completed.
Start erasing.....
Start programming...
Flashed successfully. Rebooting.
```



- Do not shutdown or reset the system while updating the BIOS to prevent system boot failure!
- A “Floppy not found!” error message appears if there is no floppy disk in the drive. A “A8VVMUT.ROM not found!” error message appears if the correct BIOS file is not found in the floppy disk. Make sure that you rename the BIOS file to A8VVMUT.ROM.

### 2.1.3 AFUDOS utility

The AFUDOS utility allows you to update the BIOS file in DOS environment using a bootable floppy disk with the updated BIOS file. This utility also allows you to copy the current BIOS file that you can use as backup when the BIOS fails or gets corrupted during the updating process.

#### Copying the current BIOS

To copy the current BIOS file using the AFUDOS utility:



- Make sure that the floppy disk is not write-protected and has at least 600 KB free space to save the file.
- The succeeding BIOS screens are for reference only. The actual BIOS screen displays may not be exactly the same as shown.

1. Copy the AFUDOS utility (afudos.exe) from the motherboard support CD to the bootable floppy disk you created earlier.
2. Boot the system in DOS mode, then at the prompt type:

```
afudos /o[filename]
```

where the [filename] is any user-assigned filename not more than eight alphanumeric characters for the main filename and three alphanumeric characters for the extension name.

```
A:\>afudos /oOLDBIOS1.ROM
```

Main filename      Extension name

3. Press <Enter>. The utility copies the current BIOS file to the floppy disk.

```
A:\>afudos /oOLDBIOS1.ROM
AMI Firmware Update Utility - Version 1.10
Copyright (C) 2002 American Megatrends, Inc. All rights reserved.
Reading flash ..... done
A:\>
```

The utility returns to the DOS prompt after copying the current BIOS file.

#### Updating the BIOS file

To update the BIOS file using the AFUDOS utility:

1. Visit the ASUS website ([www.asus.com](http://www.asus.com)) and download the latest BIOS file for the motherboard. Save the BIOS file to a bootable floppy disk.



## 2.1.4 ASUS CrashFree BIOS 2 utility

The ASUS CrashFree BIOS 2 is an auto recovery tool that allows you to restore the BIOS file when it fails or gets corrupted during the updating process. You can update a corrupted BIOS file using the motherboard support CD or the floppy disk that contains the updated BIOS file.



- Prepare the motherboard support CD or the floppy disk containing the updated motherboard BIOS before using this utility.
- Make sure that you rename the original or updated BIOS file in the floppy disk to **A8VVMUT.ROM**.

### Recovering the BIOS from a floppy disk

To recover the BIOS from a floppy disk:

1. Turn on the system.
2. Insert the floppy disk with the original or updated BIOS file to the floppy disk drive.
3. The utility displays the following message and automatically checks the floppy disk for the original or updated BIOS file.

```
Bad BIOS checksum. Starting BIOS recovery...
Checking for floppy...
```

When found, the utility reads the BIOS file and starts flashing the corrupted BIOS file.

```
Bad BIOS checksum. Starting BIOS recovery...
Checking for floppy...
Floppy found!
Reading file "A8VVMUT.ROM". Completed.
Start flashing...
```



**DO NOT** shut down or reset the system while updating the BIOS! Doing so can cause system boot failure!

4. Restart the system after the utility completes the updating process.



## Recovering the BIOS from the support CD

To recover the BIOS from the support CD:

1. Remove any floppy disk from the floppy disk drive, then turn on the system.
2. Insert the support CD to the optical drive.
3. The utility displays the following message and automatically checks the floppy disk for the original or updated BIOS file.

```
Bad BIOS checksum. Starting BIOS recovery...  
Checking for floppy...
```

When no floppy disk is found, the utility automatically checks the optical drive for the original or updated BIOS file. The utility then updates the corrupted BIOS file.

```
Bad BIOS checksum. Starting BIOS recovery...  
Checking for floppy...  
Floppy not found!  
Checking for CD-ROM...  
CD-ROM found!  
Reading file "A8VVMUT.ROM". Completed.  
Start flashing...
```



---

DO NOT shut down or reset the system while updating the BIOS! Doing so can cause system boot failure!

---

4. Restart the system after the utility completes the updating process.



---

The recovered BIOS may not be the latest BIOS version for this motherboard. Visit the ASUS website ([www.asus.com](http://www.asus.com)) to download the latest BIOS file.

---

## 2.1.5 ASUS Update utility

The ASUS Update is a utility that allows you to manage, save, and update the motherboard BIOS in Windows® environment. The ASUS Update utility allows you to:

- Save the current BIOS file
- Download the latest BIOS file from the Internet
- Update the BIOS from an updated BIOS file
- Update the BIOS directly from the Internet, and
- View the BIOS version information.

This utility is available in the support CD that comes with the motherboard package.



---

ASUS Update requires an Internet connection either through a network or an Internet Service Provider (ISP).

---

### Installing ASUS Update

To install ASUS Update:

1. Place the support CD in the optical drive. The **Drivers** menu appears.
2. Click the **Utilities** tab, then click Install **ASUS Update VX.XX.XX**. See page 3-4 for the **Utilities** screen menu.
3. The ASUS Update utility is copied to your system.



---

Quit all Windows® applications before you update the BIOS using this utility.

---

## Updating the BIOS through the Internet

To update the BIOS through the Internet:

1. Launch the ASUS Update utility from the Windows® desktop by clicking **Start > Programs > ASUS > ASUSUpdate > ASUSUpdate**. The ASUS Update main window appears.

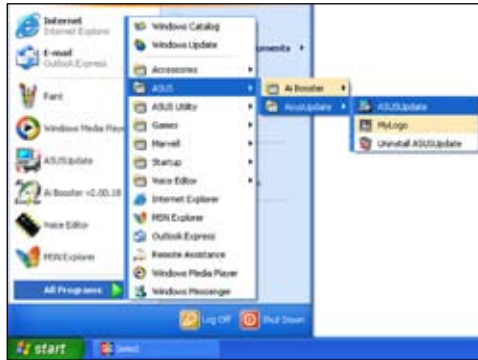

2. Select **Update BIOS from the Internet** option from the drop-down menu, then click **Next**.
3. Select the ASUS FTP site nearest you to avoid network traffic, or click **Auto Select**. Click **Next**.

- From the FTP site, select the BIOS version that you wish to download. Click **Next**.
- Follow the screen instructions to complete the update process.



The ASUS Update utility is capable of updating itself through the Internet. Always update the utility to avail all its features.



## Updating the BIOS through a BIOS file

To update the BIOS through a BIOS file:

- Launch the ASUS Update utility from the Windows® desktop by clicking **Start > Programs > ASUS > ASUSUpdate > ASUSUpdate**. The **ASUS Update** main window appears.
- Select **Update BIOS from a file** option from the drop-down menu, then click **Next**.



- Locate the BIOS file from the **Open** window, then click **Open**.
- Follow the screen instructions to complete the update process.

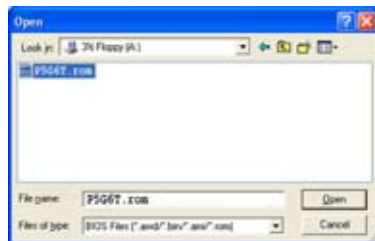

## 2.2 BIOS setup program

This motherboard supports a programmable firmware chip that you can update using the provided utility described in section “2.1 Managing and updating your BIOS.”

Use the BIOS Setup program when you are installing a motherboard, reconfiguring your system, or prompted to “Run Setup”. This section explains how to configure your system using this utility.

Even if you are not prompted to use the Setup program, you can change the configuration of your computer in the future. For example, you can enable the security password feature or change the power management settings. This requires you to reconfigure your system using the BIOS Setup program so that the computer can recognize these changes and record them in the CMOS RAM of the firmware hub.

The firmware hub on the motherboard stores the Setup utility. When you start up the computer, the system provides you with the opportunity to run this program. Press <Del> during the Power-On Self-Test (POST) to enter the Setup utility; otherwise, POST continues with its test routines.

If you wish to enter Setup after POST, restart the system by pressing <Ctrl>+<Alt>+<Del>, or by pressing the reset button on the system chassis. You can also restart by turning the system off and then back on. Do this last option only if the first two failed.

The Setup program is designed to make it as easy to use as possible. Being a menu-driven program, it lets you scroll through the various sub-menus and make your selections from the available options using the navigation keys.



- 
- The default BIOS settings for this motherboard apply for most conditions to ensure optimum performance. If the system becomes unstable after changing any BIOS settings, load the default settings to ensure system compatibility and stability. Select the **Load Default Settings** item under the Exit Menu. See section “2.7 Exit Menu.”
  - The BIOS setup screens shown in this section are for reference purposes only, and may not exactly match what you see on your screen.
  - Visit the ASUS website ([www.asus.com](http://www.asus.com)) to download the latest BIOS file for this motherboard.
-

## 2.2.1 BIOS menu screen

The screenshot shows the BIOS Setup Utility menu screen. At the top, there is a menu bar with items: Main, Advanced, Power, BIOS SETUP UTILITY, Boot, and Exit. The main area is divided into three sections: Menu items (left), Configuration fields (middle), and General help (right). The Menu items section lists System Time, System Date, Legacy Diskette A, and a list of IDE Master/Slave options. The Configuration fields section shows system time, date, and hardware information. The General help section provides instructions on how to navigate and save settings. At the bottom, there is a footer with version information and copyright details.

Labels in the image:

- Menu items: Points to the left column of the menu.
- Menu bar: Points to the top navigation bar.
- Configuration fields: Points to the middle column showing system parameters.
- General help: Points to the right column with instructions.
- Sub-menu items: Points to the list of IDE options.
- Navigation keys: Points to the bottom right corner with a list of key functions.

## 2.2.2 Menu bar

The menu bar on top of the screen has the following main items:

- Main** For changing the basic system configuration
- Advanced** For changing the advanced system settings
- Power** For changing the advanced power management (APM) configuration
- Boot** For changing the system boot configuration
- Exit** For selecting the exit options and loading default settings

To select an item on the menu bar, press the right or left arrow key on the keyboard until the desired item is highlighted.

## 2.2.3 Navigation keys

At the bottom right corner of a menu screen are the navigation keys for that particular menu. Use the navigation keys to select items in the menu and change the settings.



Some of the navigation keys differ from one screen to another.

## 2.2.4 Menu items

The highlighted item on the menu bar displays the specific items for that menu. For example, selecting Main shows the Main menu items.

The other items (Advanced, Power, Boot, and Exit) on the menu bar have their respective menu items.

## 2.2.5 Sub-menu items

A solid triangle before each item on any menu screen means that the item has a sub-menu. To display the sub-menu, select the item, then press <Enter>.

## 2.2.6 Configuration fields

These fields show the values for the menu items. If an item is user-configurable, you can change the value of the field opposite the item. You cannot select an item that is not user-configurable.

A configurable field is enclosed in brackets, and is highlighted when selected. To change the value of a field, select it then press <Enter> to display a list of options. Refer to “2.2.7 Pop-up window”.

## 2.2.7 Pop-up window

Select a menu item then press <Enter> to display a pop-up window with the configuration options for that item.

## 2.2.8 Scroll bar

A scroll bar appears on the right side of a menu screen when there are items that do not fit on the screen. Press the Up/Down arrow keys or <PageUp> / <PageDown> keys to display the other items on the screen.

## 2.2.9 General help

At the top right corner of the menu screen is a brief description of the selected item.

## 2.3 Main Menu

When you enter the BIOS Setup program, the Main menu screen appears, giving you an overview of the basic system information.



Refer to section “2.2.1 BIOS menu screen” for information on the menu screen items and how to navigate through them.

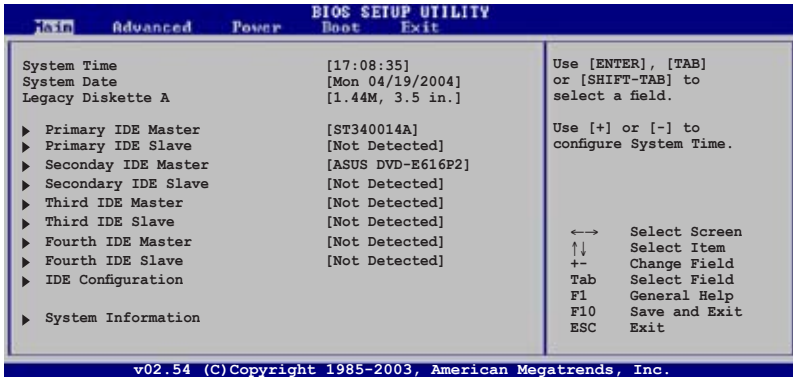

### 2.3.1 System Time [xx:xx:xx]

Allows you to set the system time.

### 2.3.2 System Date [Day xx/xx/xxxx]

Allows you to set the system date.

### 2.3.3 Legacy Diskette A [1.44M, 3.5 in.]

Sets the type of floppy drive installed. Configuration options: [Disabled] [360K, 5.25 in.] [1.2M , 5.25 in.] [720K , 3.5 in.] [1.44M, 3.5 in.] [2.88M, 3.5 in.]



## 2.3.4 Primary, Secondary, Third, Fourth IDE Master/Slave

While entering Setup, BIOS automatically detects the presence of IDE devices. There is a separate sub-menu for each IDE device. Select a device item then press <Enter> to display the IDE device information.

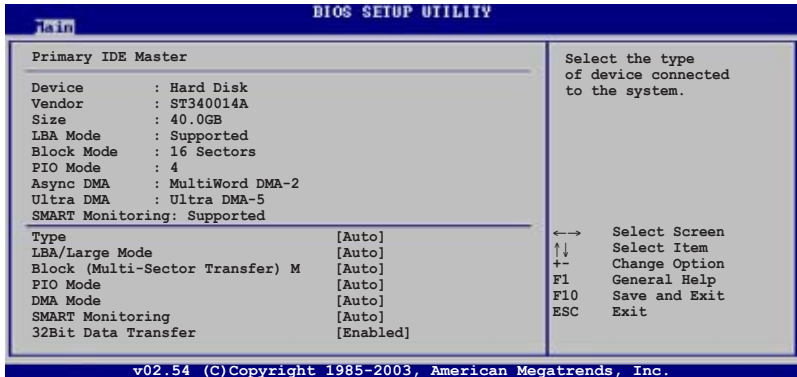

The BIOS automatically detects the values opposite the dimmed items (Device, Vendor, Size, LBA Mode, Block Mode, PIO Mode, Async DMA, Ultra DMA, and SMART monitoring). These values are not user-configurable. These items show N/A if no IDE device is installed in the system.

### Type [Auto]

Selects the type of IDE drive.

Configuration options: [Auto] [Not Installed] [CDROM] [ARMD]

### LBA/Large Mode [Auto]

Enables or disables the LBA/Large mode. Setting to Auto enables the LBA/Large mode if the device supports this mode, and if the device was not previously formatted with LBA mode disabled. Configuration options: [Auto] [Disabled]

### Block (Multi-Sector Transfer) [Auto]

Enables or disables data multi-sectors transfers. When set to Auto, the data transfer from and to the device occurs multiple sectors at a time if the device supports multi-sector transfer feature. When set to Disabled, the data transfer from and to the device occurs one sector at a time. Configuration options: [Auto] [Disabled]

### PIO Mode [Auto]

Selects the PIO mode. Configuration options: [Auto] [0] [1] [2] [3] [4]

## DMA Mode [Auto]

Selects the DMA mode. Configuration options: [Auto] [SWDMA0] [SWDMA1] [SWDMA2] [MWDMA0] [MWDMA1] [MWDMA2] [UDMA0] [UDMA1] [UDMA2] [UDMA3] [UDMA4] [UDMA5] [UDMA6]

## SMART Monitoring [Auto]

Sets the Smart Monitoring, Analysis, and Reporting Technology. Configuration options: [Auto] [Disabled] [Enabled]

## 32Bit Data Transfer [Enabled]

Enables or disables 32-bit data transfer. Configuration options: [Disabled] [Enabled]

## 2.3.5 IDE Configuration

The items in this menu allow you to set or change the configurations for the IDE devices installed in the system. Select an item then press <Enter> if you want to configure the item.

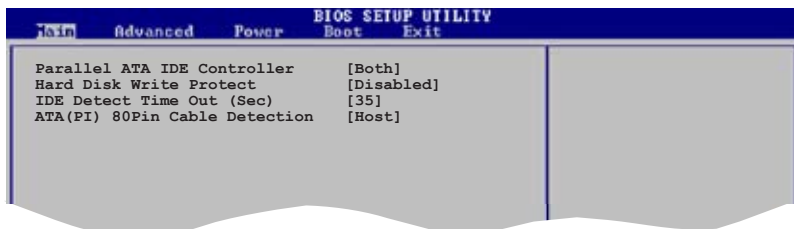

### Parallel ATA IDE Controller [Both]

Allows you to select the Parallel ATA IDE controller. Configuration options: [Disabled] [Primary] [Secondary] [Both]

### Hard Disk Write Protect [Disabled]

Allows you to enable to disable the hard disk write protection. This will be effective only if device is accessed through BIOS. Configuration options: [Disabled] [Enabled]

### IDE Detect Time Out (Sec) [35]

Allows you to select the time out value for detecting ATA or ATAPI device(s). Configuration options: [0] [5] [10] [15] [20] [25] [30] [35]

## ATA(PI) 80Pin Cable Detection [Host]

Allows you to select the mechanism for detecting 80Pin ATA(PI) cable.  
Configuration options: [Host & Device] [Host] [Device]

### 2.3.6 System Information

This menu gives you an overview of the general system specifications. The items in this menu are auto-detected by the BIOS.

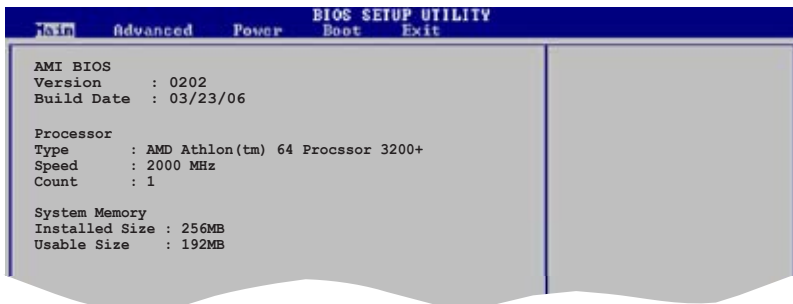

#### AMI BIOS

Displays the auto-detected BIOS information.

#### Processor

Displays the auto-detected CPU specification

#### System Memory

Displays the auto-detected system memory.

## 2.4 Advanced menu

The Advanced menu items allow you to change the settings for the CPU and other system devices.



Take caution when changing the settings of the Advanced menu items. Incorrect field values can cause the system to malfunction.

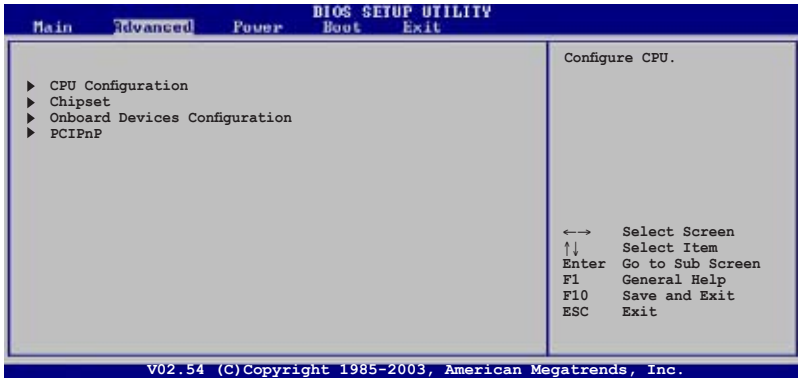

### 2.4.1 CPU Configuration

The items in this menu show the CPU-related information that the BIOS automatically detects.

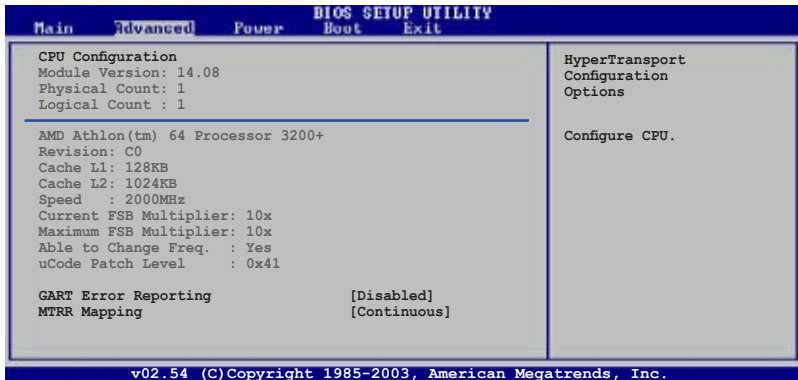

## GART Error Reporting [Disabled]

Enables or disables the GART error reporting feature.

Configuration options: [Disabled] [Enabled]

## MTRR Mapping [Continuous]

Determines the method used for programming CPU MTRRs when using over 4G of system memory. Configuration options: [Continuous] [Discrete]

## 2.4.2 Chipset

The Chipset menu allows you to change the advanced chipset settings. Select an item then press <Enter> to display the sub-menu.

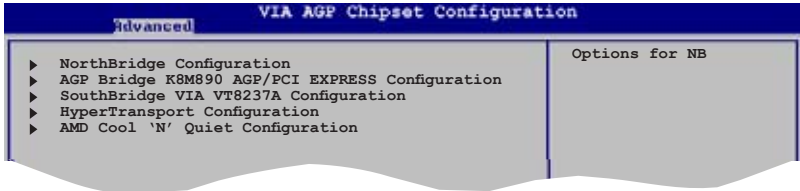

# NorthBridge Configuration

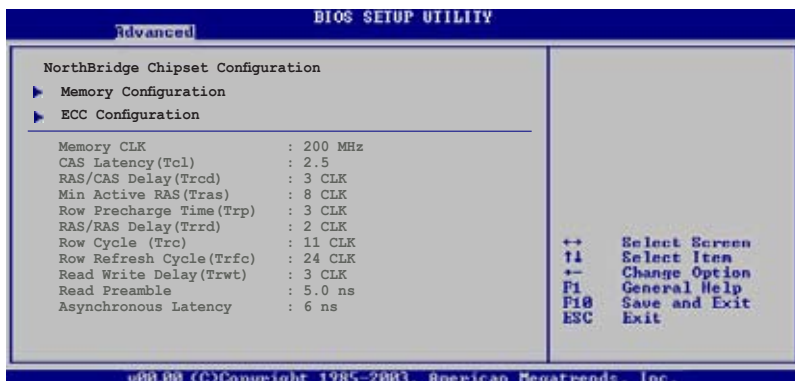

## Memory Configuration



### Memclock Mode [Auto]

Sets the memory clock mode. Configuration options: [Auto] [Limit]



The following item appears when the Memclock Mode item is set to [Limit].

### Memclock Value [100MHz]

Configuration options: [100MHz] [133MHz] [166MHz] [183MHz] [200MHz] [216MHz] [233MHz] [250MHz]

## MCT Timing Mode [Auto]

Sets the MCT Timing mode.

Configuration options: [Auto] [Manual]



---

The following item appears when the **MCT Time Mode** item is set to [Manual].

---

### CAS Latency (CL) [Auto]

Configuration options: [Auto] [2.0] [3.0] [2.5]

### TRAS [Auto]

Configuration options: [Auto] [5 CLK] [6 CLK]... [15 CLK]

### TRP [Auto]

Configuration options: [Auto] [2 CLK] [3 CLK]... [6 CLK]

### TRCD [Auto]

Configuration options: [Auto] [2 CLK] [3 CLK]... [6 CLK]

### TRRD [Auto]

Configuration options: [Auto] [2T] [3T] [4T]

### TRC [Auto]

Configuration options: [Auto] [7T] [8T] [9T]... [22T]

### TRFC [Auto]

Configuration options: [Auto] [9T] [10T] [11T]... [24T]

### TRWT [Auto]

Configuration options: [Auto] [1 CLK] [2 CLK] [3 CLK]... [6 CLK]

## User Config Mode [Auto]

Sets the user config mode. Configuration options: [Auto] [Manual]



---

The following item appears when the **User Config Mode** item is set to [Manual].

---

### **Read Preamble [9.5ns]**

Configuration options: [2.0ns] [2.5ns] [3.0ns] [3.5ns] [4.0ns]... [9.5ns]

### **Async Latency [11.0ns]**

Configuration options: [4.0ns] [5.0ns] [6.0ns]... [11.0ns]

### **CMD-ADDR Timing Mode [2T]**

Configuration options: [1T] [2T]

## Bank Interleaving [Auto]

Configuration options: [Auto] [Disable]

## Burst Length [4 Beats]

Sets the operating burst length.

Configuration options: [8 Beats] [4 Beats] [2 Beats]

## Hardware Memory Hole [Disabled]

Enables or disables the hardware memory hole.

Configuration options: [Disabled] [Enabled]

## DDR Reference Voltage [Auto]

Sets the DDR reference voltage.

Configuration options: [Auto] [2.6V] [2.5]

### ECC Configuration

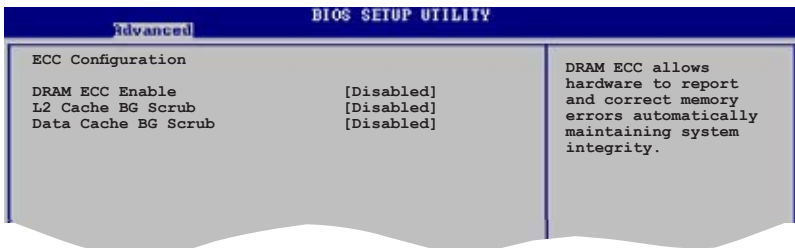

## DRAM ECC Enable [Disabled]

Allows you to enable or disable the DRAM ECC.

Configuration options: [Disabled] [Enabled]



---

The following item appears when the **DRAM ECC** item is set to [Enabled].

### **MCA DRAM ECC Logging [Disabled]**

Enables or disables the MCA DRAM ECC logging.

Configuration options: [Disabled] [Enabled]

### **ECC Chip Kill [Disabled]**

Enables or disables the ECC Chip Kill function.

Configuration options: [Disabled] [Enabled]

### **DRAM SCRUB REDIRECT [Disabled]**

Enables or disables the DRAM SCRUB REDIRECT.

Configuration options: [Disabled] [Enabled]



### **DRAM BG SCRUB [Disabled]**

Disables or sets the DRAM BG SCRUB.

Configuration options: [Disabled] [40ns] [80ns] [160ns] [320ns] [640ns] [1.28us] [2.56us] [5.12us] [10.2us] [20.5us] [41.0us] [81.9us] [163.8us] [327.7us] [655.4us] [1.31ms] [2.62ms] [5.24ms] [10.49ms] [20.97ms] [42.00ms] [84.00ms]

### **L2 Cache BG Scrub [Disabled]**

Disables or sets the L2 Cache BG Scrub.

Configuration options: [Disabled] [40ns] [80ns] [160ns] [320ns] [640ns] [1.28us] [2.56us] [5.12us] [10.2us] [20.5us] [41.0us] [81.9us] [163.8us] [327.7us] [655.4us] [1.31ms] [2.62ms] [5.24ms] [10.49ms] [20.97ms] [42.00ms] [84.00ms]

### **Data Cache BG Scrub [Disabled]**

Disables or sets the Data Cache BG Scrub.

Configuration options: [Disabled] [40ns] [80ns] [160ns] [320ns] [640ns] [1.28us] [2.56us] [5.12us] [10.2us] [20.5us] [41.0us] [81.9us] [163.8us] [327.7us] [655.4us] [1.31ms] [2.62ms] [5.24ms] [10.49ms] [20.97ms] [42.00ms] [84.00ms]

## **AGP Bridge K8M890 AGP/PCI EXPRESS Configuration**



### **OnChip VGA Frame Buffer Size [64MB]**

Allows you to disable or set the onchip VGA frame buffer size. Configuration options: [Disabled] [64MB] [128MB] [256MB]

### **Primary Graphics Adapter [PCIE VGA]**

Allows selection of the graphics controller to use as a primary boot device. Configuration options: [PCI] [PCIE VGA] [Integrated VGA]

## SouthBridge Configuration

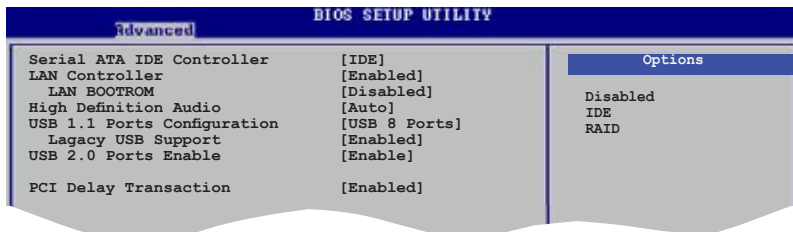

### Serial ATA IDE Controller [IDE]

This option allows you to set the Serial ATA IDE controller mode.  
Configuration options: [Disabled] [IDE] [RAID]

### LAN Controller [Enabled]

This option allows you to enable or disable the LAN controller.  
Configuration options: [Disabled] [Enabled]

#### LAN BootROM [Disabled]

This option allows you to enable or disable the LAN boot ROM.  
Configuration options: [Disabled] [Enabled]

### High Definition Audio [Auto]

This option allows you to set the High Definition Audio.  
Configuration options: [Disabled] [Auto]

### USB 1.1 Ports Configuration [USB 8 Ports]

This option allows you to enable 1.1 USB host controllers.  
Configuration options: [Disabled] [USB 2 Ports] [USB 4 Ports] [USB 6 Ports] [USB 8 Ports]

#### Legacy USB Support [Enabled]

This option allows you to enable support for legacy USB. Auto option disables legacy support if no USB devices are connected.  
Configuration options: [Disabled] [Auto] [Enabled]

### USB 2.0 Ports Enable [Enable]

This option allows you to enable 2.0 USB host controllers.  
Configuration options: [Disabled] [Enable]

### PCI Delay Transaction [Enabled]

Allows you to enable or disable the PCI Delay Transaction.  
Configuration options: [Disabled] [Enabled]

# Hyper Transport Geforce 6100 Configuration

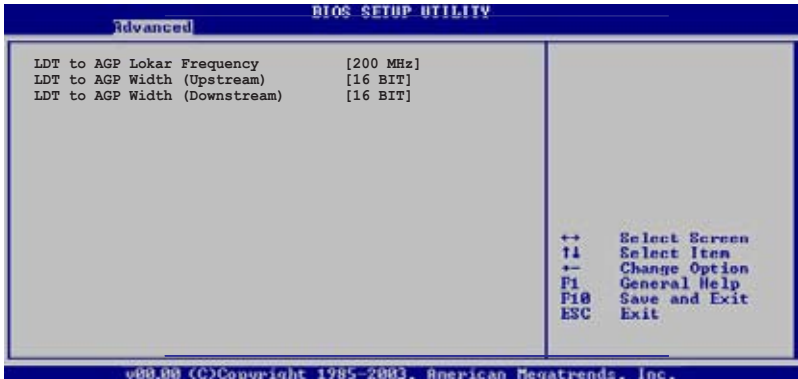

## LDT to AGP Lokar Frequency [Auto]

Configuration options: [Auto] [200MHz] [400MHz] [600MHz] [800MHz] [1000MHz]

## LDT to AGP Width (Upstream) [16 BIT]

Configuration options: [16 BIT] [8 BIT]

## LDT to AGP Width (Downstream) [16 BIT]

Configuration options: [16 BIT] [8 BIT]

# AMD Cool'N'Quiet Configuration

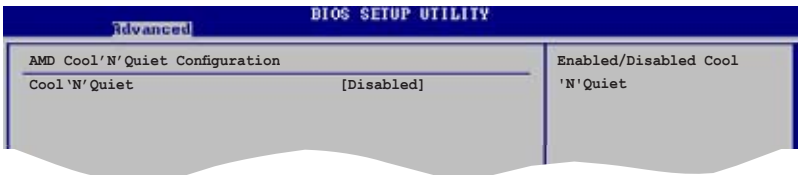

## Cool 'N' Quiet [Disabled]

Enables or disables the AMD Cool 'n' Quiet technology feature.  
Configuration options: [Enabled] [Disabled]

## 2.4.3 Onboard Devices Configuration

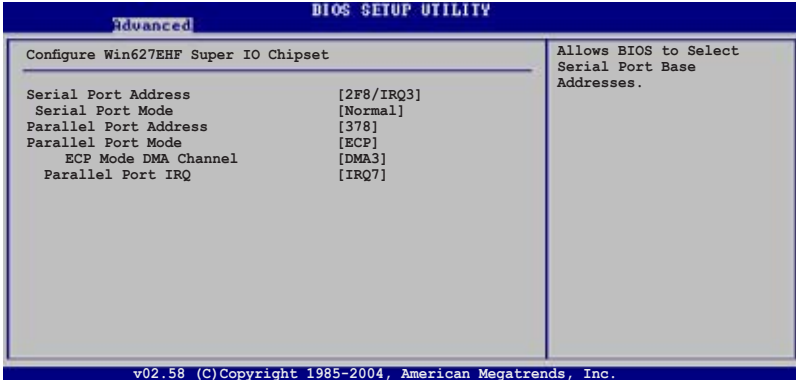

### Serial Port Address [2F8/IRQ3]

Allows you to select the Serial Port2 base address.

Configuration options: [Disabled] [2F8/IRQ3] [3E8/IRQ4] [2E8/IRQ3] [3F8/IRQ4]

#### Serial Port Mode [Normal]

Allows you to select the Serial port mode.

Configuration options: [Normal] [IrDA] [ASK IR]

### Parallel Port Address [378]

Allows you to select the Parallel Port base addresses.

Configuration options: [Disabled] [378] [278] [3BC]

### Parallel Port Mode [ECP]

Allows you to select the Parallel Port mode. When the item Parallel Port Address is set to 3BC, the Parallel Port Mode options are only Normal, Bi-directional, and ECP.

Configuration options: [Normal] [Bi-directional] [EPP] [ECP]

#### ECP Mode DMA Channel [DMA3]

Allows selection of the Parallel Port ECP DMA channel.

Configuration options: [DMA0] [DMA1] [DMA3]

#### Parallel Port IRQ [IRQ7]

Allows you to select the Parallel Port IRQ.

Configuration options: [IRQ5] [IRQ7]

## 2.4.4 PCI PnP

The PCI PnP menu items allow you to change the advanced settings for PCI/PnP devices. The menu includes setting IRQ and DMA channel resources for either PCI/PnP or legacy ISA devices, and setting the memory size block for legacy ISA devices.



Take caution when changing the settings of the PCI PnP menu items. Incorrect field values can cause the system to malfunction.

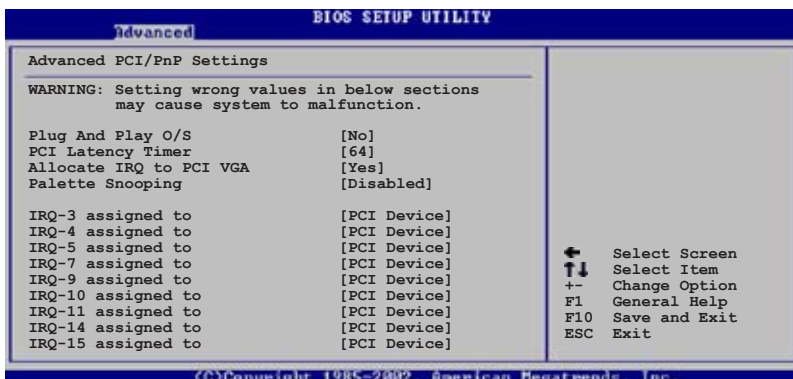

### Plug and Play O/S [No]

When set to [No], BIOS configures all the devices in the system. When set to [Yes] and if you install a Plug and Play operating system, the operating system configures the Plug and Play devices not required for boot. Configuration options: [No] [Yes]

### PCI Latency Timer [64]

Allows you to select the value in units of PCI clocks for the PCI device latency timer register. Configuration options: [32] [64] [96] [128] [160] [192] [224] [248]

### Allocate IRQ to PCI VGA [Yes]

When set to [Yes], BIOS assigns an IRQ to PCI VGA card if the card requests for an IRQ. When set to [No], BIOS does not assign an IRQ to the PCI VGA card even if requested. Configuration options: [No] [Yes]

### Palette Snooping [Disabled]

When set to [Enabled], the palette snooping feature informs the PCI devices that an ISA graphics device is installed in the system so that the latter can function correctly. Configuration options: [Disabled] [Enabled]

## 2.5 Power menu

The Power menu items allow you to change the settings for the Advanced Configuration and Power Interface (ACPI) and the Advanced Power Management (APM). Select an item then press <Enter> to display the configuration options.

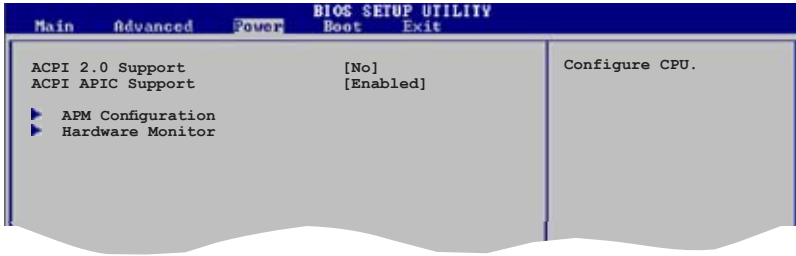

### 2.5.1 ACPI 2.0 Support [No]

Allows you to add more tables for Advanced Configuration and Power Interface (ACPI) 2.0 specifications. Configuration options: [No] [Yes]

### 2.5.2 ACPI APIC Support [Enabled]

Allows you to enable or disable the Advanced Configuration and Power Interface (ACPI) support in the Application-Specific Integrated Circuit (ASIC). When set to Enabled, the ACPI APIC table pointer is included in the RSDT pointer list. Configuration options: [Disabled] [Enabled]

## 2.5.3 APM Configuration

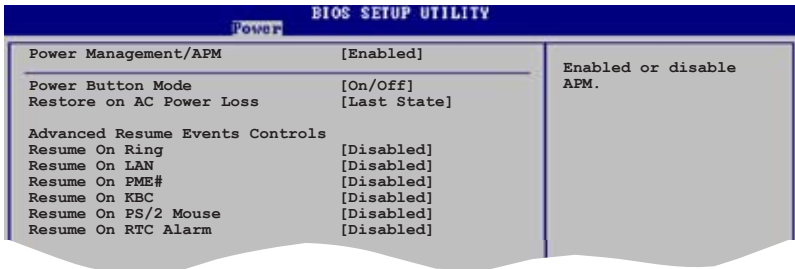

### Power Management/APM [Enabled]

Allows you to enable to disable the Power Management/APM function.  
Configuration options: [Enabled] [Disabled]

### Power Button Mode [On/Off]

Allows the system to go into On/Off mode or suspend mode when the power button is pressed. Configuration options: [On/Off] [Suspend]

### Restore on AC Power Loss [Last State]

When set to Power Off, the system goes into off state after an AC power loss. When set to Power On, the system goes on after an AC power loss. When set to Last State, the system goes into either off or on state, whatever the system state was before the AC power loss.  
Configuration options: [Power Off] [Power On] [Last State]

### Resume On Ring [Disabled]

When set to [Enabled], the system enables the RI to generate a wake event while the computer is in Soft-off mode.  
Configuration options: [Disabled] [Enabled]

### Resume On LAN [Disabled]

When set to [Enabled], this parameter allows you to turn on the system through a PCI LAN or modem card. This feature requires an ATX power supply that provides at least 1A on the +5VSB lead.  
Configuration options: [Disabled] [Enabled]

### Resume On PME# [Disabled]

When set to [Enabled], the system enables the PME to generate a wake event while the computer is in Soft-off mode.  
Configuration options: [Disabled] [Enabled]

### **Resume On KBC [Disabled]**

When set to [Enabled], this parameter allows you to use the PS/2 keyboard to turn on the system. This feature requires an ATX power supply that provides at least 1A on the +5VSB lead. Configuration options: [Disabled] [Enabled]

### **Resume On PS/2 Mouse [Disabled]**

When set to [Enabled], this parameter allows you to use the PS/2 mouse to turn on the system. This feature requires an ATX power supply that provides at least 1A on the +5VSB lead. Configuration options: [Disabled] [Enabled]

### **Resume On RTC Alarm [Disabled]**

Allows you to enable or disable RTC to generate a wake event. When this item is set to Enabled, the items RTC Alarm Date, and System Time appear with set values. Configuration options: [Disabled] [Enabled]



## 2.5.4 Hardware Monitor

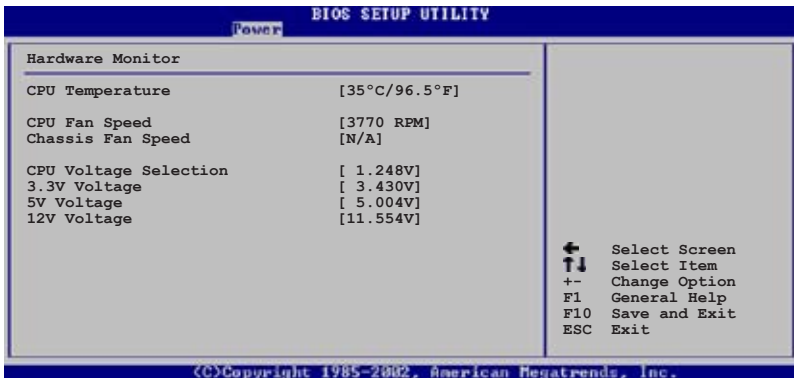

### CPU Temperature [xxxC/xxxF]

The onboard hardware monitor automatically detects and displays the motherboard and CPU temperatures. Select [Ignored] if you do not wish to display the detected temperatures.

Configuration options: [Ignored] [xxxC/xxxF]

### CPU Fan Speed [xxxxRPM] or [N/A]

The onboard hardware monitor automatically detects and displays the CPU fan speed in rotations per minute (RPM). If the fan is not connected to the motherboard, the field shows N/A.

Configuration options: [Ignored] [xxxRPM]

### Chassis Fan Speed [xxxxRPM] or [N/A]

The onboard hardware monitor automatically detects and displays the chassis fan speed in rotations per minute (RPM). If the fan is not connected to the chassis, the specific field shows N/A.

Configuration options: [Ignored] [xxxRPM] or [N/A]

### VCORE Voltage, 3.3V Voltage, 5V Voltage, 12V Voltage

The onboard hardware monitor automatically detects the voltage output through the onboard voltage regulators.

## 2.6 Boot menu

The Boot menu items allow you to change the system boot options. Select an item then press <Enter> to display the sub-menu.

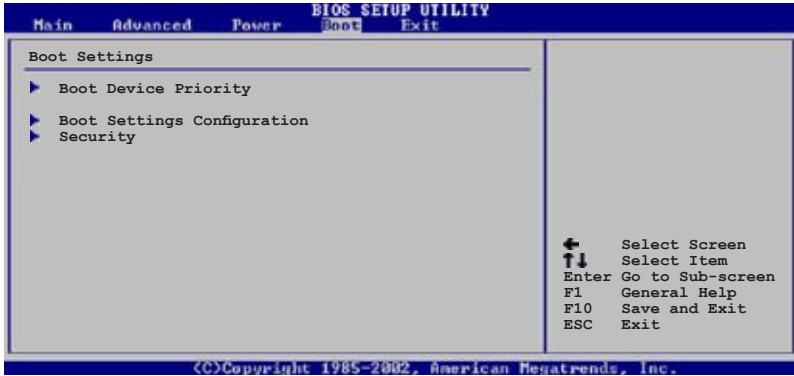

### 2.6.1 Boot Device Priority

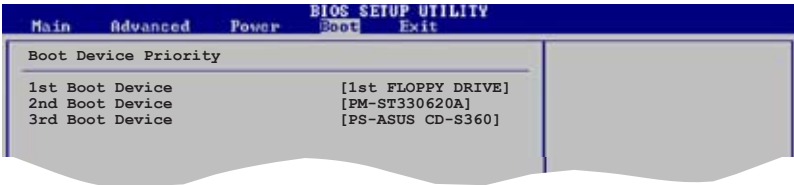

#### 1st ~ xxth Boot Device [1st Floppy Drive]

These items specify the boot device priority sequence from the available devices. The number of device items that appears on the screen depends on the number of devices installed in the system.

Configuration options: [xxxxx Drive] [Disabled]

## 2.6.2 Boot Settings Configuration

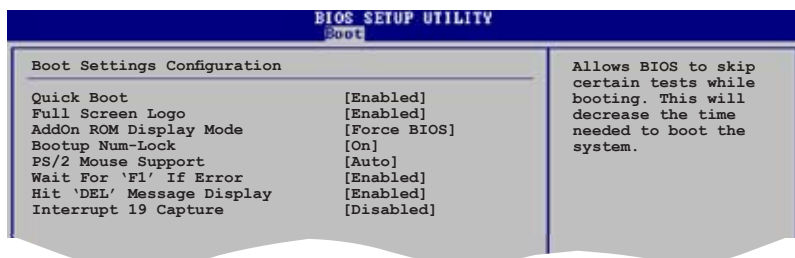

### Quick Boot [Enabled]

Enabling this item allows the BIOS to skip some power on self tests (POST) while booting to decrease the time needed to boot the system. When set to [Disabled], BIOS performs all the POST items.

Configuration options: [Disabled] [Enabled]

### Full Screen Logo [Enabled]

This allows you to enable or disable the full screen logo display feature.

Configuration options: [Disabled] [Enabled]



Set this item to [Enabled] to use the ASUS MyLogo™ feature.

### Add On ROM Display Mode [Force BIOS]

Sets the display mode for option ROM.

Configuration options: [Force BIOS] [Keep Current]

### Bootup Num-Lock [On]

Allows you to select the power-on state for the NumLock.

Configuration options: [Off] [On]

### PS/2 Mouse Support [Auto]

Allows you to enable or disable support for PS/2 mouse.

Configuration options: [Disabled] [Enabled] [Auto]

### Wait for 'F1' If Error [Enabled]

When set to Enabled, the system waits for the F1 key to be pressed when error occurs. Configuration options: [Disabled] [Enabled]

### Hit 'DEL' Message Display [Enabled]

When set to Enabled, the system displays the message "Press DEL to run Setup" during POST. Configuration options: [Disabled] [Enabled]

## Interrupt 19 Capture [Disabled]

When set to [Enabled], this function allows the option ROMs to trap Interrupt 19. Configuration options: [Disabled] [Enabled]

### 2.6.3 Security

The Security menu items allow you to change the system security settings. Select an item then press <Enter> to display the configuration options.

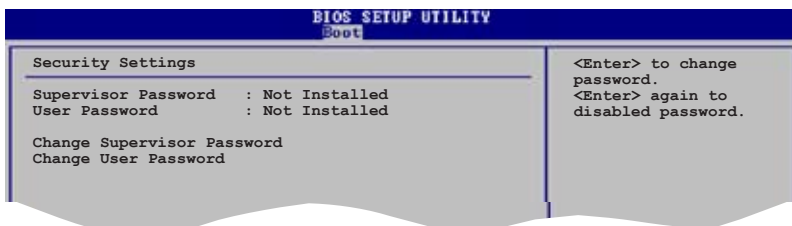

#### Change Supervisor Password

Select this item to set or change the supervisor password. The Supervisor Password item on top of the screen shows the default Not Installed. After you set a password, this item shows Installed.

To set a Supervisor Password:

1. Select the Change Supervisor Password item and press <Enter>.
2. From the password box, type a password composed of at least six letters and/or numbers, then press <Enter>.
3. Confirm the password when prompted.

The message "Password Installed" appears after you successfully set your password.

To change the supervisor password, follow the same steps as in setting a user password.

To clear the supervisor password, select the Change Supervisor Password then press <Enter>. The message "Password Uninstalled" appears.



---

If you forget your BIOS password, you can clear it by erasing the CMOS Real Time Clock (RTC) RAM. See section "2.6 Jumpers" for information on how to erase the RTC RAM.

---

After you have set a supervisor password, the other items appear to allow you to change other security settings.

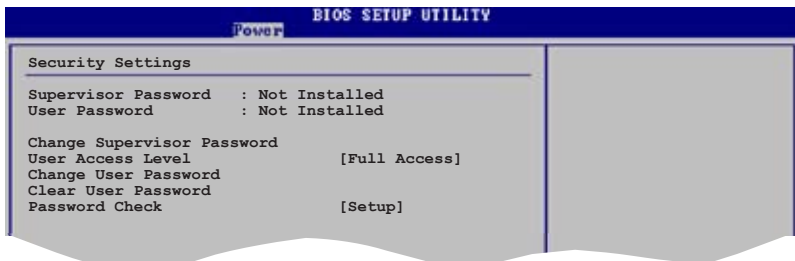

### User Access Level [Full Access]

This item allows you to select the access restriction to the Setup items. Configuration options: [No Access] [View Only] [Limited] [Full Access]

No Access prevents user access to the Setup utility.

View Only allows access but does not allow change to any field.

Limited allows changes only to selected fields, such as Date and Time.

Full Access allows viewing and changing all the fields in the Setup utility.

### Change User Password

Select this item to set or change the user password. The User Password item on top of the screen shows the default Not Installed. After you set a password, this item shows Installed.

To set a User Password:

1. Select the Change User Password item and press <Enter>.
2. On the password box that appears, type a password composed of at least six letters and/or numbers, then press <Enter>.
3. Confirm the password when prompted.

The message "Password Installed" appears after you set your password successfully.

To change the user password, follow the same steps as in setting a user password.

### Change User Password

Select this item to set or change the user password. The User Password item on top of the screen shows the default Not Installed. After you set a password, this item shows Installed.

To set a User Password:

1. Select the Change User Password item and press <Enter>.
2. On the password box that appears, type a password composed of at least six letters and/or numbers, then press <Enter>.
3. Confirm the password when prompted.

The message “Password Installed” appears after you set your password successfully.

To change the user password, follow the same steps as in setting a user password.

## 2.7 Exit menu

The Exit menu items allow you to load the optimal or failsafe default values for the BIOS items, and save or discard your changes to the BIOS items.



Pressing <Esc> does not immediately exit this menu. Select one of the options from this menu or <F10> from the legend bar to exit.

### Exit & Save Changes

Once you are finished making your selections, choose this option from the Exit menu to ensure the values you selected are saved to the CMOS RAM. An onboard backup battery sustains the CMOS RAM so it stays on even when the PC is turned off. When you select this option, a confirmation window appears. Select Ok to save changes and exit.



If you attempt to exit the Setup program without saving your changes, the program prompts you with a message asking if you want to save your changes before exiting. Press <Enter> to save the changes while exiting.

## **Exit & Discard Changes**

Select this option only if you do not want to save the changes that you made to the Setup program. If you made changes to fields other than System Date, System Time, and Password, the BIOS asks for a confirmation before exiting.

## **Discard Changes**

This option allows you to discard the selections you made and restore the previously saved values. After selecting this option, a confirmation appears. Select Ok to discard any changes and load the previously saved values.

## **Load Setup Defaults**

This option allows you to load the default values for each of the parameters on the Setup menus. When you select this option or if you press <F5>, a confirmation window appears. Select Ok to load default values. Select Exit & Save Changes or make other changes before saving the values to the non-volatile RAM.





This chapter describes the contents of the support CD that comes with the motherboard package.

# 3 Software support

## 3.1 Installing an operating system

This motherboard supports Windows® 2000/2003 Server/XP/64-bit XP operating systems (OS). Always install the latest OS version and corresponding updates to maximize the features of your hardware.



- Motherboard settings and hardware options vary. Use the setup procedures presented in this chapter for reference only. Refer to your OS documentation for detailed information.
- Make sure that you install Windows® 2000 Service Pack 4 or the Windows® XP Service Pack 2 or later versions before installing the drivers for better compatibility and system stability.

## 3.2 Support CD information

The support CD that came with the motherboard package contains the drivers, software applications, and utilities that you can install to avail all motherboard features.



The contents of the support CD are subject to change at any time without notice. Visit the ASUS website([www.asus.com](http://www.asus.com)) for updates.

### 3.2.1 Running the support CD

Place the support CD to the optical drive. The CD automatically displays the Drivers menu if Autorun is enabled in your computer.

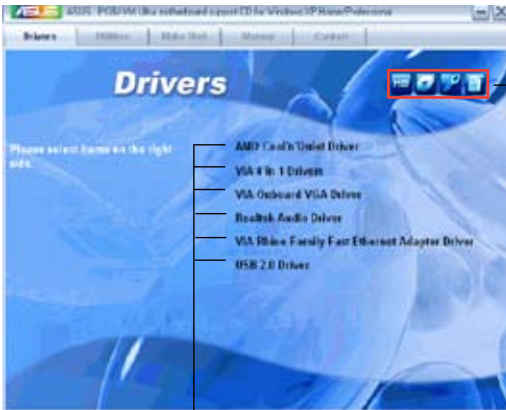

Click an icon to display support CD/motherboard information

Click an item to install



If **Autorun** is NOT enabled in your computer, browse the contents of the support CD to locate the file **ASSETUP.EXE** from the BIN folder. Double click the **ASSETUP.EXE** to run the CD.

### 3.2.2 Drivers menu

The drivers menu shows the available device drivers if the system detects installed devices. Install the necessary drivers to activate the devices.



#### **AMD Cool 'n'Quiet Drivers**

Installs AMD Cool 'n'Quiet Drivers.

#### **VIA 4 in 1 Drivers**

Install VIA 4 in 1 drivers.

#### **VIA Onboard VGA Driver**

Installs VIA Onboard VGA Driver.

#### **Realtek Audio Driver**

Installs Realtek Audio Driver.

#### **VIA Rhine Family Fast Ethernet Adapter Driver**

Install VIA Rhine Family Fast Ethernet Adapter driver.

#### **USB2.0 Driver**

Installs USB2.0 Driver.

### 3.2.3 Utilities menu

The Utilities menu shows the applications and other software that the motherboard supports.



#### ASUS Cool ‘n’Quiet Utility

Launches the ASUS Cool ‘n’ Quiet!™ Technology driver installation wizard.

#### ASUS PC Probe II

This smart utility monitors the fan speed, CPU temperature, and system voltages, and alerts you of any detected problems. This utility helps you keep your computer in healthy operating condition.

#### ASUS Update

Allows you to download the latest version of the BIOS from the ASUS website.



---

Before using the ASUS Update, make sure that you have an Internet connection so you can connect to the ASUS website.

---

#### ASUS Screen Saver

Bring life to your computer screen by installing the ASUS screen saver.

#### ADOBE Acrobat Reader

Installs the Adobe® Acrobat® Reader V7.0 that allows you to open, view, and print documents in Portable Document Format (PDF).

## Microsoft DirectX

Installs the Microsoft® DirectX 9.0c driver. The Microsoft DirectX® 9.0c is a multimedia technology that enhances computer graphics and sound. DirectX® improves the multimedia features of your computer so you can enjoy watching TV and movies, capturing videos, or playing games in your computer. Visit the Microsoft website ([www.microsoft.com](http://www.microsoft.com)) for updates.

## Anti-virus Utility

The anti-virus application scans, identifies, and removes computer viruses. View the online help for detailed information.

### 3.2.4 Make disk menu

The Utilities menu shows you to make a RAID driver disk.



## VIA RAID Driver

Allows you to create a VT8237A 32/64bit RAID driver disk.

### 3.2.5 Manual

The Manual menu contains a VIA8237A RAID User Manual. Click the item to open the manual.



### VIA8237A SATA Quick setup User's Manual

Allows you to open the VIA8237A SATA quick setup user's manual.

### 3.2.6 ASUS Contact information

Click the Contact tab to display the ASUS contact information. You can also find this information on the inside front cover of this user guide.

