

N4L-VM DH

ASUS[®]

Motherboard

E2410

First Edition V1

March 2006

Copyright © 2006 ASUSTeK COMPUTER INC. All Rights Reserved.

No part of this manual, including the products and software described in it, may be reproduced, transmitted, transcribed, stored in a retrieval system, or translated into any language in any form or by any means, except documentation kept by the purchaser for backup purposes, without the express written permission of ASUSTeK COMPUTER INC. (“ASUS”).

Product warranty or service will not be extended if: (1) the product is repaired, modified or altered, unless such repair, modification or alteration is authorized in writing by ASUS; or (2) the serial number of the product is defaced or missing.

ASUS PROVIDES THIS MANUAL “AS IS” WITHOUT WARRANTY OF ANY KIND, EITHER EXPRESS OR IMPLIED, INCLUDING BUT NOT LIMITED TO THE IMPLIED WARRANTIES OR CONDITIONS OF MERCHANTABILITY OR FITNESS FOR A PARTICULAR PURPOSE. IN NO EVENT SHALL ASUS, ITS DIRECTORS, OFFICERS, EMPLOYEES OR AGENTS BE LIABLE FOR ANY INDIRECT, SPECIAL, INCIDENTAL, OR CONSEQUENTIAL DAMAGES (INCLUDING DAMAGES FOR LOSS OF PROFITS, LOSS OF BUSINESS, LOSS OF USE OR DATA, INTERRUPTION OF BUSINESS AND THE LIKE), EVEN IF ASUS HAS BEEN ADVISED OF THE POSSIBILITY OF SUCH DAMAGES ARISING FROM ANY DEFECT OR ERROR IN THIS MANUAL OR PRODUCT.

SPECIFICATIONS AND INFORMATION CONTAINED IN THIS MANUAL ARE FURNISHED FOR INFORMATIONAL USE ONLY, AND ARE SUBJECT TO CHANGE AT ANY TIME WITHOUT NOTICE, AND SHOULD NOT BE CONSTRUED AS A COMMITMENT BY ASUS. ASUS ASSUMES NO RESPONSIBILITY OR LIABILITY FOR ANY ERRORS OR INACCURACIES THAT MAY APPEAR IN THIS MANUAL, INCLUDING THE PRODUCTS AND SOFTWARE DESCRIBED IN IT.

Products and corporate names appearing in this manual may or may not be registered trademarks or copyrights of their respective companies, and are used only for identification or explanation and to the owners’ benefit, without intent to infringe.

Contents

Notices	vii
Safety information	viii
About this guide	ix
N4L-VM DH specifications summary	xi

Chapter 1: Product introduction

1.1	Welcome!	1-1
1.2	Package contents	1-1
1.3	Special features	1-2
1.3.1	Product highlights	1-2
1.3.2	ASUS Special features	1-5

Chapter 2: Hardware information

2.1	Before you proceed	2-1
2.2	Motherboard overview	2-2
2.2.1	Placement direction	2-2
2.2.2	Screw holes	2-2
2.2.3	Motherboard layout	2-3
2.2.4	Layout contents	2-4
2.3	Central Processing Unit (CPU)	2-6
2.3.1	Installing the CPU	2-6
2.3.2	Installing the CPU heatsink and fan	2-8
2.4	System memory	2-10
2.4.1	Overview	2-10
2.4.2	Memory configurations	2-10
2.4.3	Installing a DIMM	2-15
2.4.4	Removing a DIMM	2-15
2.5	Expansion slots	2-16
2.5.1	Installing an expansion card	2-16
2.5.2	Configuring an expansion card	2-16
2.5.3	Interrupt assignments	2-17
2.5.4	PCI slots	2-18
2.5.5	PCI Express x1 slot	2-18
2.5.6	PCI Express x16 slot	2-18
2.6	Jumpers	2-21

Contents

2.7	Connectors	2-24
2.7.1	Rear panel connectors	2-24
2.7.2	Internal connectors	2-26

Chapter 3: Powering up

3.1	Starting up for the first time	3-1
3.2	Powering off the computer	3-2
3.2.1	Using the OS shut down function	3-2
3.2.2	Using the dual function power switch	3-2

Chapter 4: BIOS setup

4.1	Managing and updating your BIOS	4-1
4.1.1	ASUS Update utility	4-1
4.1.2	Creating a bootable floppy disk	4-4
4.1.3	ASUS EZ Flash utility	4-5
4.1.4	AFUDOS utility	4-6
4.1.5	ASUS CrashFree BIOS 2 utility	4-9
4.2	BIOS setup program	4-11
4.2.1	BIOS menu screen	4-12
4.2.2	Menu bar	4-12
4.2.3	Navigation keys	4-12
4.2.4	Menu items	4-13
4.2.5	Sub-menu items	4-13
4.2.6	Configuration fields	4-13
4.2.7	Pop-up window	4-13
4.2.8	Scroll bar	4-13
4.2.9	General help	4-13
4.3	Main menu	4-14
4.3.1	System Time	4-14
4.3.2	System Date	4-14
4.3.3	Legacy Diskette A	4-14
4.3.4	Primary and Secondary IDE Master/Slave	4-15
4.3.5	IDE configuration	4-16
4.3.6	System Information	4-17

Contents

4.4	Advanced menu	4-18
4.4.1	JumperFree Configuration	4-18
4.4.2	CPU Configuration	4-20
4.4.3	Chipset	4-21
4.4.4	Onboard Devices Configuration	4-24
4.4.5	PCI PnP	4-26
4.4.6	USB Configuration	4-27
4.5	Power menu	4-29
4.5.1	Suspend Mode	4-29
4.5.2	Repost Video on S3 Resume	4-29
4.5.3	ACPI 2.0 Support	4-29
4.5.4	ACPI APIC Support	4-29
4.5.5	APM Configuration	4-30
4.5.6	Hardware Monitor	4-32
4.5.7	Energy Lake Feature	4-33
4.6	Boot menu	4-34
4.6.1	Boot Device Priority	4-34
4.6.2	Boot Settings Configuration	4-35
4.6.3	Security	4-36
4.7	Exit menu	4-38

Chapter 5: Software support

5.1	Installing an operating system	5-1
5.2	Support CD information	5-1
5.2.1	Running the support CD	5-1
5.2.2	Drivers menu	5-2
5.2.3	Utilities menu	5-4
5.2.4	Make Disk menu	5-5
5.2.5	Manuals menu	5-6
5.2.6	ASUS Contact information	5-6
5.2.7	Other information	5-7
5.3	Software information	5-9
5.3.1	ASUS MyLogo™	5-9
5.3.2	Audio configurations	5-11
5.3.3	ASUS PC Probe II	5-18
5.3.4	Intel® Viiv™	5-24

5.4	RAID configurations	5-27
5.4.1	Installing hard disks	5-27
5.4.2	Intel® RAID configurations	5-28
5.4.3	JMicron® RAID Configuration	5-36
5.5	Creating a RAID driver disk	5-42

Notices

Federal Communications Commission Statement

This device complies with Part 15 of the FCC Rules. Operation is subject to the following two conditions:

- This device may not cause harmful interference, and
- This device must accept any interference received including interference that may cause undesired operation.

This equipment has been tested and found to comply with the limits for a Class B digital device, pursuant to Part 15 of the FCC Rules. These limits are designed to provide reasonable protection against harmful interference in a residential installation. This equipment generates, uses and can radiate radio frequency energy and, if not installed and used in accordance with manufacturer's instructions, may cause harmful interference to radio communications. However, there is no guarantee that interference will not occur in a particular installation. If this equipment does cause harmful interference to radio or television reception, which can be determined by turning the equipment off and on, the user is encouraged to try to correct the interference by one or more of the following measures:

- Reorient or relocate the receiving antenna.
- Increase the separation between the equipment and receiver.
- Connect the equipment to an outlet on a circuit different from that to which the receiver is connected.
- Consult the dealer or an experienced radio/TV technician for help.



The use of shielded cables for connection of the monitor to the graphics card is required to assure compliance with FCC regulations. Changes or modifications to this unit not expressly approved by the party responsible for compliance could void the user's authority to operate this equipment.

Canadian Department of Communications Statement

This digital apparatus does not exceed the Class B limits for radio noise emissions from digital apparatus set out in the Radio Interference Regulations of the Canadian Department of Communications.

This class B digital apparatus complies with Canadian ICES-003.

Safety information

Electrical safety

- To prevent electrical shock hazard, disconnect the power cable from the electrical outlet before relocating the system.
- When adding or removing devices to or from the system, ensure that the power cables for the devices are unplugged before the signal cables are connected. If possible, disconnect all power cables from the existing system before you add a device.
- Before connecting or removing signal cables from the motherboard, ensure that all power cables are unplugged.
- Seek professional assistance before using an adapter or extension cord. These devices could interrupt the grounding circuit.
- Make sure that your power supply is set to the correct voltage in your area. If you are not sure about the voltage of the electrical outlet you are using, contact your local power company.
- If the power supply is broken, do not try to fix it by yourself. Contact a qualified service technician or your retailer.

Operation safety

- Before installing the motherboard and adding devices on it, carefully read all the manuals that came with the package.
- Before using the product, make sure all cables are correctly connected and the power cables are not damaged. If you detect any damage, contact your dealer immediately.
- To avoid short circuits, keep paper clips, screws, and staples away from connectors, slots, sockets and circuitry.
- Avoid dust, humidity, and temperature extremes. Do not place the product in any area where it may become wet.
- Place the product on a stable surface.
- If you encounter technical problems with the product, contact a qualified service technician or your retailer.

About this guide

This user guide contains the information you need when installing and configuring the motherboard.

How this guide is organized

This guide contains the following parts:

- **Chapter 1: Product introduction**
This chapter describes the features of the motherboard and the new technology it supports.
- **Chapter 2: Hardware information**
This chapter lists the hardware setup procedures that you have to perform when installing system components. It includes description of the switches, jumpers, and connectors on the motherboard.
- **Chapter 3: Powering up**
This chapter describes the power up sequence and ways of shutting down the system.
- **Chapter 4: BIOS setup**
This chapter tells how to change system settings through the BIOS Setup menus. Detailed descriptions of the BIOS parameters are also provided.
- **Chapter 5: Software support**
This chapter describes the contents of the support CD that comes with the motherboard package.

Where to find more information

Refer to the following sources for additional information and for product and software updates.

1. ASUS websites

The ASUS website provides updated information on ASUS hardware and software products. Refer to the ASUS contact information.

2. Optional documentation

Your product package may include optional documentation, such as warranty flyers, that may have been added by your dealer. These documents are not part of the standard package.

Conventions used in this guide

To make sure that you perform certain tasks properly, take note of the following symbols used throughout this manual.



DANGER/WARNING: Information to prevent injury to yourself when trying to complete a task.



CAUTION: Information to prevent damage to the components when trying to complete a task.



IMPORTANT: Instructions that you **MUST** follow to complete a task.



NOTE: Tips and additional information to help you complete a task.

Typography

Bold text

Indicates a menu or an item to select.

Italics

Used to emphasize a word or a phrase.

<Key>

Keys enclosed in the less-than and greater-than sign means that you must press the enclosed key.

Example: <Enter> means that you must press the Enter or Return key.

<Key1+Key2+Key3>

If you must press two or more keys simultaneously, the key names are linked with a plus sign (+).

Example: <Ctrl+Alt+D>

Command

Means that you must type the command exactly as shown, then supply the required item or value enclosed in brackets.

Example: At the DOS prompt, type the command line:

```
afudos /i[filename]  
afudos /iN4L-VM.ROM
```

N4L-VM DH specifications summary

CPU	Socket 479 for Intel® Core™ Duo/Core™ Solo processor Supports Intel® Viiv™ Technology* <i>*Note: Requires Intel® Core™ Duo processor</i>
Chipset	Northbridge: Intel® 945GM Memory Controller Hub (MCH) Southbridge: Intel® ICH7-M (DH)
Front Side Bus	667/533 MHz
Memory	Dual-channel memory architecture 2 x 240-pin DIMM sockets support up to 2 GB unbuffered non-ECC DDR2 667/533 MHz memory modules <i>Note: Refer to www.asus.com for the latest memory Qualified Vendors List (QVL).</i>
Expansion slots	1 x PCI Express™ x16 slot 1 x PCI Express™ x1 slot 2 x PCI slots
Graphics	Integrated Intel® Graphics Media Accelerator 950
Storage	Intel® ICH7-M (DH) Southbridge supports: - 1 x Ultra DMA 100 connector for two devices - 2 x Serial ATA devices with RAID 0, RAID 1, and Intel® Matrix Storage configuration JMicron® Serial ATA controller supports: - 1 x Internal Serial ATA 3.0 Gb/s - 1 x External Serial ATA 3.0 Gb/s (SATA On-the-Go) - RAID 0, RAID 1 configuration <i>Note: Do not remove/unplug External SATA device when running under RAID mode .</i>
AI Audio	Realtek® ALC882M 8-channel CODEC 1 x Coaxial S/PDIF out port 1 x Optical S/PDIF out port Supports Jack Sensing, Retasking, and Enumeration Technology Supports Multi-Streaming
LAN	Intel® 82573L Gigabit LAN controller (Vidalia)
IEEE 1394a	TI 1394a controller supports: - 2 x IEEE 1394a connectors at 400 Mbps speed (1 at midboard, 1 on the rear panel)
USB	Supports up to 8 USB 2.0 ports

(continued on the next page)

N4L-VM DH specifications summary

ASUS Special features	ASUS C.P.R. (CPU Parameter Recall) ASUS MyLogo ASUS Q-Fan ASUS EZ Flash ASUS CrashFree BIOS 2
Rear panel	1 x VGA port 1 x LAN (RJ-45) port 4 x USB 2.0 ports 1 x IEEE 1394a port 1 x External Serial ATA port 1 x Optical S/PDIF Out port 1 x Coaxial S/PDIF Out port 1 x PS/2 keyboard port (purple) 1 x PS/2 mouse port (green) 8-channel audio ports
Internal connectors	1 x 24-pin ATX power connector 1 x 4-pin ATX 12 V power connector 2 x USB connectors for 4 additional USB 2.0 ports 1 x CD audio in connector 1 x Chassis intrusion connector 1 x LPT connector 1 x Serial (COM1) connector 1 x Game connector 1 x CPU fan connector 1 x Chassis fan connector 1 x Front panel audio connector 1 x SPDIF In/Out connector 1 x TV Out connector System panel connector
BIOS features	8 Mb Flash ROM, AMI BIOS, PnP, DMI, WfM2.0, ACPI 2.0a, SM BIOS 2.3
Manageability	PXE, WOR by Ring, WOL/WOR by PME, WO USB, WO KB/MS
Support CD contents	Device drivers ASUS PC Probe II ASUS LiveUpdate Anti-Virus Utility Intervideo® WinDVD® Suite
Form Factor	uATX form factor: 9.6 in x 9.6 in (24.5 cm x 24.5 cm)

*Specifications are subject to change without notice.

This chapter describes the motherboard features and the new technologies it supports.

Product introduction



Chapter summary



1.1	Welcome!	1-1
1.2	Package contents	1-1
1.3	Special features	1-2

1.1 Welcome!

Thank you for buying an ASUS® N4L-VM DH motherboard!

The motherboard delivers a host of new features and latest technologies, making it another standout in the long line of ASUS quality motherboards!

Before you start installing the motherboard, and hardware devices on it, check the items in your package with the list below.

1.2 Package contents

Check your motherboard package for the following items.

Motherboard	ASUS N4L-VM DH motherboard
I/O modules	1 x 2-port USB 2.0 module 1 x IEEE 1394a module
Cables	1 x Serial ATA cable 1 x Serial ATA power cable 1 x Ultra DMA 100 cable 1 x Floppy disk drive cable
Accessory	I/O shield CPU fan and heatsink
Application CDs	ASUS motherboard support CD WinDVD Suite
Documentation	User guide



If any of the above items is damaged or missing, contact your retailer.

1.3 Special features

1.3.1 Product highlights

Latest processor technology

The motherboard comes with a 479-pin, surface-mount, Zero Insertion Force (ZIF) mPGA479M socket designed for the Intel® Core™ Duo and Core™ Solo processors. Built on Intel® 65-nanometer process technology with copper interconnect, the Intel® Core™ Duo processor delivers breakthrough dual-core performance and enhanced media experience with low power consumption. The Intel® Core™ Duo processor utilizes the latest package technologies for a thinner, lighter design without compromising performance. See page 2-6 for details.

Intel® Dual-Core Technology CPU support

The motherboard supports dual-core processors containing two physical CPU cores with dedicated L2 caches to meet demands for more powerful processing. See page 2-6 for details.

Intel® 945GM/Intel® ICH7-M (DH) chipset

The Intel® 945GM Memory Controller Hub (MCH) and the Intel® ICH7-M (DH) I/O controller hub provide the vital interfaces for the motherboard. The Intel® 945GM is the latest chipset designed to support the Intel® Core™ family processor in the 479-ball Micro FCPGA package to deliver enhanced performance at low power consumption. The chipset supports high-bandwidth interfaces such as PCI Express, Serial ATA, and USB 2.0. The chipset also features the Intel® Graphics Media Accelerator 950, an integrated graphics engine for enhanced 3D, 2D, and video capabilities.

Intel® Viiv™ Technology support

Intel® Viiv™ Technology transforms your PC into an entertainment center, allowing you to enjoy and share digital multi-media content like never before. With Intel® Viiv™ Technology-based computers, you can record, playback, organize, and edit digital media content easily. Enjoy the entertainment experience even more with sharp graphics, flawless video playback, and support for up to 7.1 channel surround sound. To enable Intel® Viiv™ Technology, make sure you enable the Quick Resume function called **Energy Lake** in the BIOS. Refer to the BIOS screen on page 4-29. You also need to install the Intel® Viiv™ Technology driver and software. See pages 5-3 and 5-24 for details.

DDR2 memory support

The motherboard supports DDR2 memory that features data transfer rates of 667 MHz or 533 MHz to meet the higher bandwidth requirements of the latest 3D graphics, multimedia, and Internet applications. The dual-channel DDR2 architecture doubles the bandwidth of your system memory to boost system performance, eliminating bottlenecks with peak bandwidths of up to 10.7 GB/s. See pages 2-10 to 2-14 for details.

Dual RAID solution

Onboard RAID controllers provide the motherboard with dual-RAID functionality that allows you to select the best RAID solution using Serial ATA devices.

The Intel® ICH7-M (DH) Southbridge allows RAID 0, RAID 1, and Intel® Matrix Storage configuration with two Serial ATA connectors. See pages 2-27 and 5-28.

The Jmicron® JMB363 Serial ATA controller supports one internal and one external Serial ATA 3.0 Gb/s devices with RAID 0 and RAID 1 configuration. See pages 2-28 and 5-36 for details.

Gigabit LAN solution

The motherboard comes with the Intel® 82573L Gigabit LAN controller to provide the total solution for your networking needs. This network controller uses the PCI Express segment to provide faster data bandwidth for your wired or wireless Internet, LAN, and file sharing requirements. See page 2-24 for details.

PCI Express™ interface

The motherboard fully supports PCI Express, the latest I/O interconnect technology that speeds up the PCI bus. PCI Express features point-to-point serial interconnections between devices and allows higher clockspeeds by carrying data in packets. This high speed interface is software compatible with existing PCI specifications. See page 2-18 for details.

S/PDIF digital sound ready

The motherboard supports the S/PDIF technology through the S/PDIF interfaces on the rear panel and at midboard. The S/PDIF technology turns your computer into a high-end entertainment system with digital connectivity to powerful audio and speaker systems. See page 2-35 for details.

8-channel High Definition Audio



Onboard is the Realtek® ALC882M High Definition Audio 8-channel audio CODEC. This CODEC is fully-compliant with Intel® High Definition Audio standard (192 KHz, 24-bit audio). With the CODEC, audio ports, and S/PDIF interfaces, you can connect your computer to home theater decoders to produce crystal-clear digital audio.

The Realtek® ALC882M CODEC comes with an AC-3 encoder capable of transforming your computer's digital audio contents into real-time Dolby® Digital stream. This digital stream passes through the S/PDIF out interfaces to an AC-3 decoder for 7.1-channel feedback.

The Realtek® ALC882M CODEC comes with a software application that features jack detection to monitor the plugging status of each jack, impedance sensing to determine audio device classes, and pre-defined equalization for various audio devices. See pages 2-24, 2-25, and 5-11 for details.

Theater-level audio (designed for Dolby® Master Studio



This motherboard offers theater-level 7.1 surround sound and audio specifications higher than that of DVD. Enjoy true home theater experience with the following advanced sound technologies: Dolby IIX, Dolby Headphone, Dolby Virtual Speaker, and Dolby Digital Live. See page 5-16 for details.

IEEE 1394a support



The IEEE 1394a interface provides high-speed and flexible PC connectivity to a wide range of peripherals and devices compliant to the IEEE 1394a standard. The IEEE 1394a interface allows up to 400 Mbps transfer rates through simple, low-cost, high-bandwidth asynchronous (real-time) data interfacing between computers, peripherals, and consumer electronic devices such as camcorders, VCRs, printers, TVs, and digital cameras. See page 2-24 for details.

USB 2.0 technology



The motherboard implements the Universal Serial Bus (USB) 2.0 specification, dramatically increasing the connection speed from the 12 Mbps bandwidth on USB 1.1 to a fast 480 Mbps on USB 2.0. USB 2.0 is backward compatible with USB 1.1. See pages 2-25 and 2-29 for details.

1.3.2 ASUS Special features

Serial ATA II and SATA-On-The-Go



The motherboard supports the Serial ATA II 3 Gb/s technology through the JMicron Serial ATA interfaces. The Serial ATA 3 Gb/s specification provides twice the bandwidth of the current Serial ATA products with a host of new features, including Native Command Queuing (NCQ), Power Management (PM) Implementation Algorithm, and Hot Swap. Serial ATA allows thinner, more flexible cables with lower pin count and reduced voltage requirements.

Leveraging these Serial ATA II 3Gb/s features is the SATA-On-The-Go. This external port on the rear panel I/O provides smart setup, hot-plug and support for up to 16 devices with port-multiplier functions. See pages 2-25 and 2-26 for details.

ASUS Q-Fan technology



The ASUS Q-Fan technology smartly adjusts the CPU fan speeds according to the system loading to ensure quiet, cool, and efficient operation. See page 4-32 for details.

ASUS MyLogo™



This feature allows you to personalize and add style to your system with customizable boot logos. See page 5-9 for details.

C.P.R. (CPU Parameter Recall)



The C.P.R. feature of the motherboard BIOS allows automatic re-setting to the BIOS default settings in case the system hangs due to overclocking. When the system hangs due to overclocking, C.P.R. eliminates the need to open the system chassis and clear the RTC data. Simply shut down and reboot the system, and the BIOS automatically restores the CPU default setting for each parameter.

This chapter lists the hardware setup procedures that you have to perform when installing system components. It includes description of the jumpers and connectors on the motherboard.

Hardware information



Chapter summary



2.1	Before you proceed	2-1
2.2	Motherboard overview	2-2
2.3	Central Processing Unit (CPU)	2-6
2.4	System memory	2-10
2.5	Expansion slots	2-16
2.6	Jumpers	2-21
2.7	Connectors	2-24

2.1 Before you proceed

Take note of the following precautions before you install motherboard components or change any motherboard settings.



- Unplug the power cord from the wall socket before touching any component.
- Use a grounded wrist strap or touch a safely grounded object or a metal object, such as the power supply case, before handling components to avoid damaging them due to static electricity.
- Hold components by the edges to avoid touching the ICs on them.
- Whenever you uninstall any component, place it on a grounded antistatic pad or in the bag that came with the component.
- **Before you install or remove any component, ensure that the ATX power supply is switched off or the power cord is detached from the power supply.** Failure to do so may cause severe damage to the motherboard, peripherals, and/or components.

Onboard LED

The motherboard comes with a standby power LED. The green LED lights up to indicate that the system is ON, in sleep mode, or in soft-off mode. This is a reminder that you should shut down the system and unplug the power cable before removing or plugging in any motherboard component. The illustration below shows the location of the onboard LED.

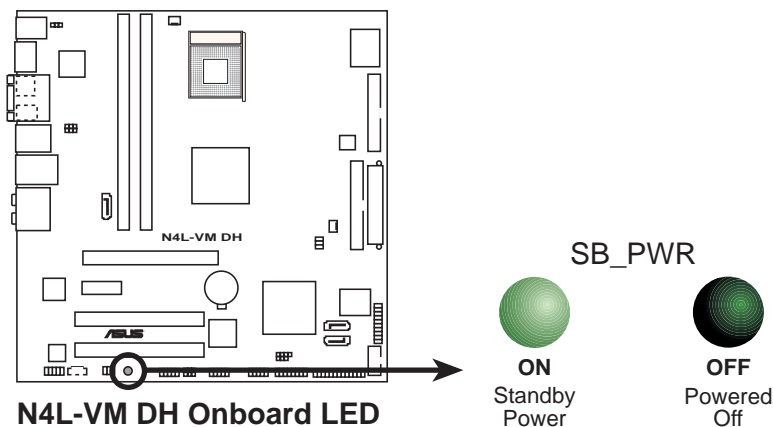

2.2 Motherboard overview

Before you install the motherboard, study the configuration of your chassis to ensure that the motherboard fits into it.



Make sure to unplug the power cord before installing or removing the motherboard. Failure to do so can cause you physical injury and damage motherboard components.

2.2.1 Placement direction

When installing the motherboard, make sure that you place it into the chassis in the correct orientation. The edge with external ports goes to the rear part of the chassis as indicated in the image below.

2.2.2 Screw holes

Place eight (8) screws into the holes indicated by circles to secure the motherboard to the chassis.



Do not overtighten the screws! Doing so can damage the motherboard.

Place this side towards
the rear of the chassis

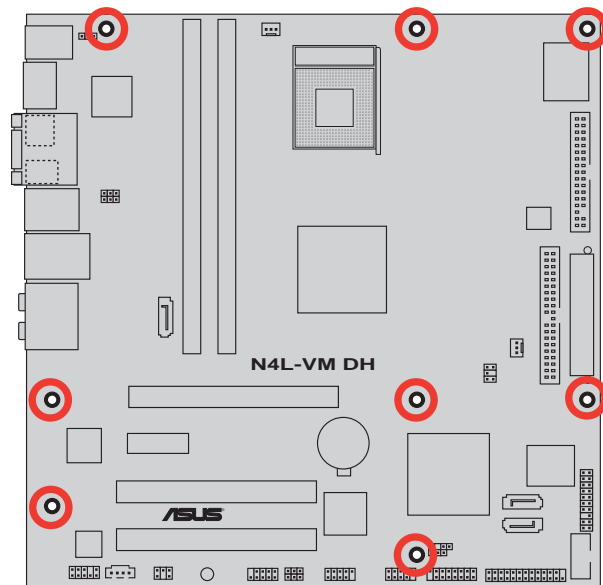

2.2.3 Motherboard layout

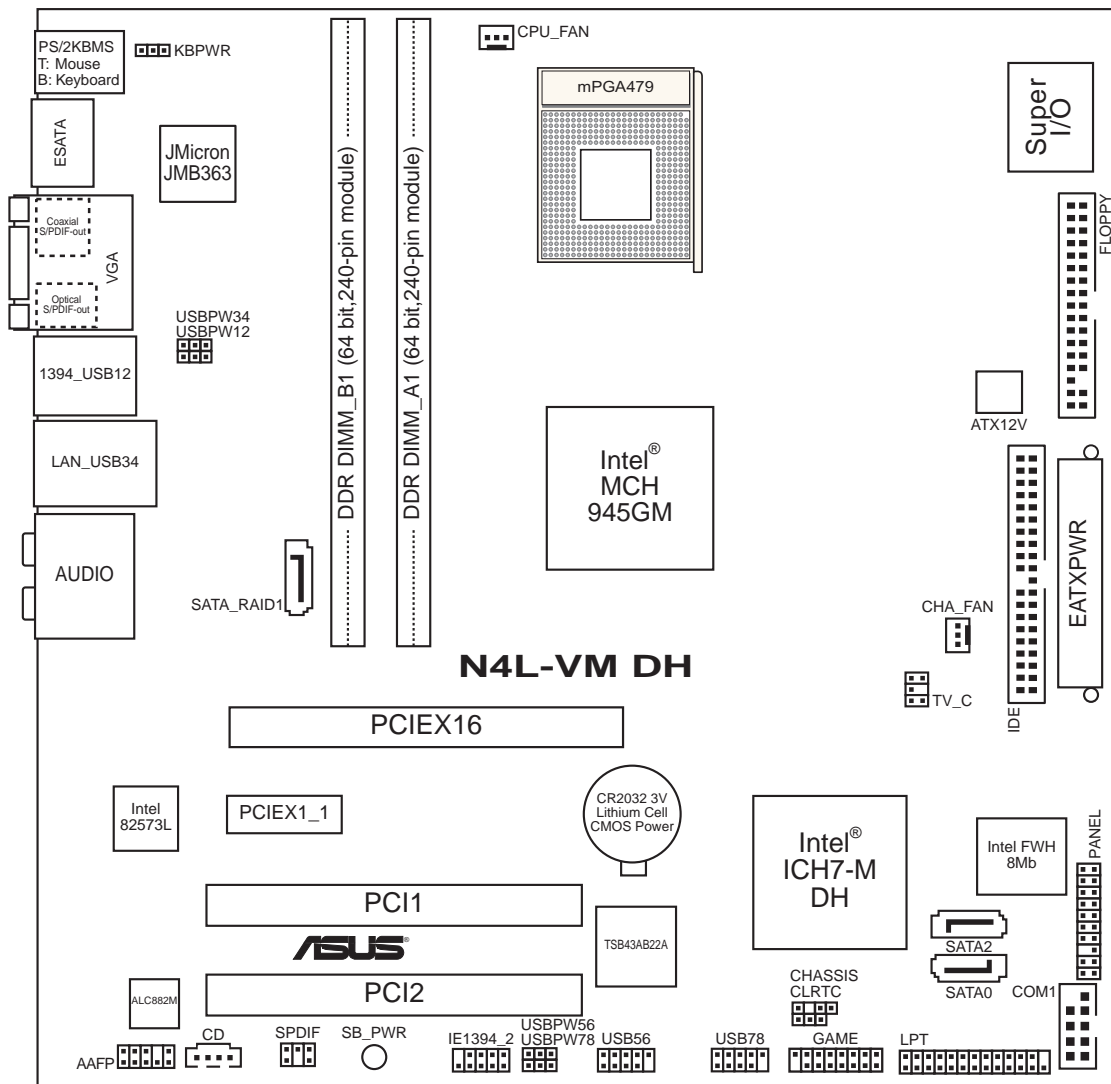

2.2.4 Layout contents

Slots	Page
1. DDR2 DIMM slots	2-10
2. PCI slots	2-18
3. PCI Express x1 slot	2-18
4. PCI Express x16 slot	2-18

Jumper	Page
1. Clear RTC RAM (3-pin CLRTC)	2-21
2. USB device wake-up (3-pin USBPW12, USBPW34, USBPW56, USBPW78)	2-22
3. Keyboard power (3-pin KBPWR)	2-23

Rear panel connectors	Page
1. PS/2 mouse port (green)	2-24
2. VGA port	2-24
3. IEEE 1394a port	2-24
4. LAN (RJ-45) port	2-24
5. Rear Speaker Out port (black)	2-24
6. Center/Subwoofer port (orange)	2-24
7. Line In port (light blue)	2-24
8. Line Out port (lime)	2-24
9. Microphone port (pink)	2-24
10. Side Speaker Out port (gray)	2-25
12. USB 2.0 ports 1 and 2	2-25
13. Optical S/PDIF Out port	2-25
14. Coaxial S/PDIF Out port	2-25
15. External SATA port	2-25
16. PS/2 keyboard port (purple)	2-25

Internal connectors		Page
1.	Floppy disk drive connector (34-1 pin FLOPPY)	2-26
2.	IDE connector (40-1 pin IDE)	2-26
3.	Intel® ICH7-M DH Southbridge Serial ATA connectors (7-pin SATA0 [black], SATA2 [black])	2-27
4.	JMicron Serial ATA 3.0 Gb/s RAID connector (7-pin SATA_RAID1 [red])	2-28
5.	CD audio in connector (4-pin CD)	2-28
6.	USB connectors (10-1 pin USB56, USB78)	2-29
7.	Front panel audio connector (10-1 pin AAFP)	2-30
8.	IEEE 1394a port connector (10-1 pin IE1394_2)	2-30
9.	GAME/MIDI port connector (16-1 pin GAME)	2-31
10.	Serial port connector (10-1 pin COM1)	2-31
11.	CPU and chassis fan connectors (3-pin CPU_FAN, 3-pin CHA_FAN)	2-32
12.	Chassis intrusion connector (4-1 pin CHASSIS)	2-32
13.	ATX power connectors (24-pin EATXPWR, 4-pin ATX12V)	2-33
14.	Parallel port connector (26-1 pin LPT)	2-34
15.	S/PDIF In/Out connector (6-1 pin SPDIF)	2-35
16.	TV Out connector (6-1 pin TV_C)	2-35
17.	System panel connector (20-pin PANEL) <ul style="list-style-type: none"> • System power LED (Green 3-pin PLED) • Hard disk drive activity LED (Red 2-pin IDE_LED) • System warning speaker (Orange 4-pin SPEAKER) • ATX power button/soft-off button (Light green 2-pin PWR) • Reset button (Blue 2-pin RESET) 	2-36

2.3 Central Processing Unit (CPU)

The motherboard comes with a 479-pin, surface-mount, Zero Insertion Force (ZIF) mPGA479M socket designed for the Intel® Core™ Duo/Core™ Solo processor.

2.3.1 Installing the CPU

To install a CPU:

1. Locate the CPU socket on the motherboard.

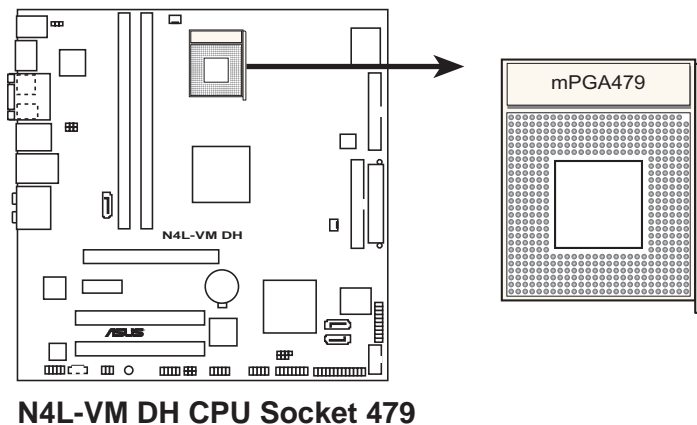

2. Unlock the socket by pressing the lever sideways, then lift it up to a 90°- 100° angle.

Socket lever

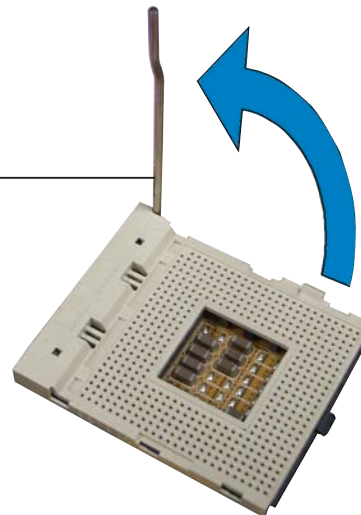

Make sure that the socket lever is lifted up to 90°-100° angle; otherwise, the CPU will not fit in completely.

3. Position the CPU above the socket such that the CPU corner matches the socket corner with a small triangle.
4. Carefully insert the CPU into the socket until it fits in place.

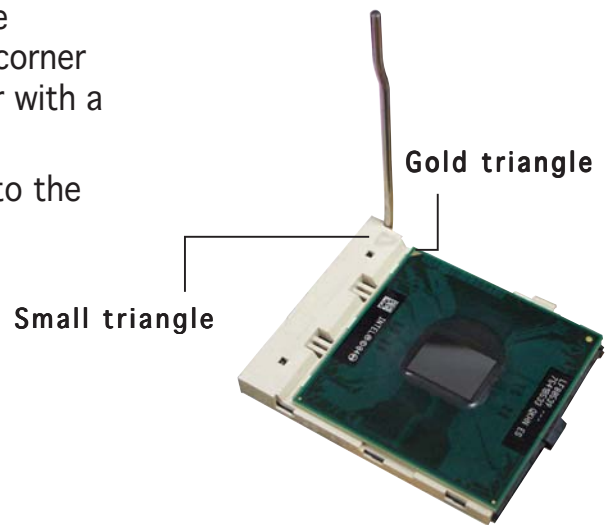

5. When the CPU is in place, push down the socket lever to secure the CPU. The lever clicks on the side tab to indicate that it is locked.
6. Install a CPU heatsink and fan following the instructions that came with the heatsink package.

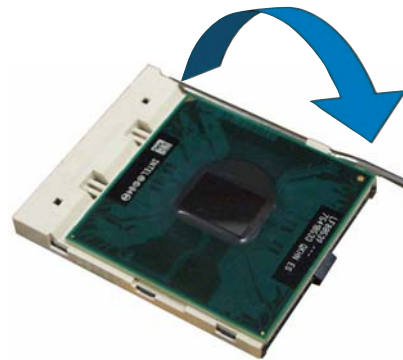

The motherboard supports the Intel® Core™ Duo socket 479 processor.

2.3.2 Installing the CPU heatsink and fan

The Intel® Core™ family processor requires a specially designed heatsink and fan assembly to ensure optimum thermal condition and performance.

To install the CPU heatsink and fan:

1. Place the heatsink on top of the installed CPU.



Orient the heatsink and fan assembly such that the CPU fan cable is closest to the CPU fan connector.

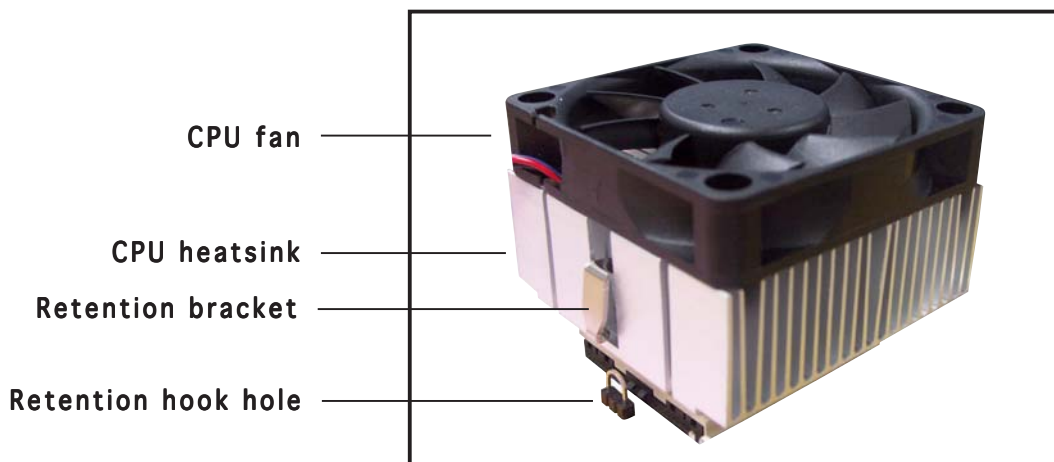

2. Push down one end of the retention bracket into the retention hook hole.

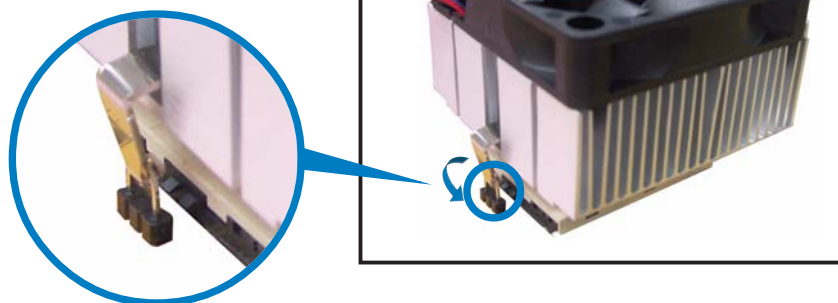

3. Push down the handle until the other end of the retention bracket is hooked into the hole to secure the heatsink and fan to the motherboard.

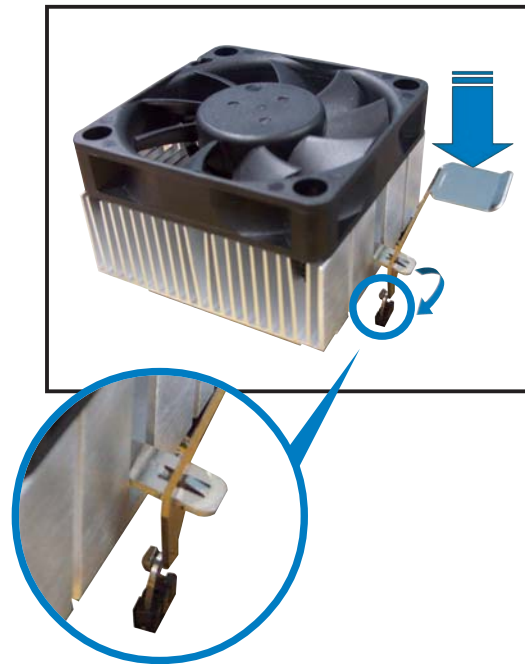

4. Connect the CPU fan cable to the connector on the motherboard labeled CPU_FAN.

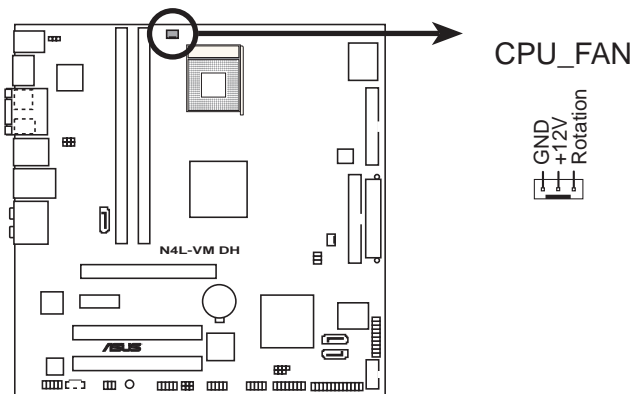

N4L-VM DH CPU fan connector



Do not forget to connect the CPU fan connector! Hardware monitoring errors can occur if you fail to plug this connector.

2.4 System memory

2.4.1 Overview

The motherboard comes with four Double Data Rate 2 (DDR2) Dual Inline Memory Modules (DIMM) sockets.

A DDR2 module has the same physical dimensions as a DDR DIMM but has a 240-pin footprint compared to the 184-pin DDR DIMM. DDR2 DIMMs are notched differently to prevent installation on a DDR DIMM socket.

The figure illustrates the location of the DDR2 DIMM sockets:

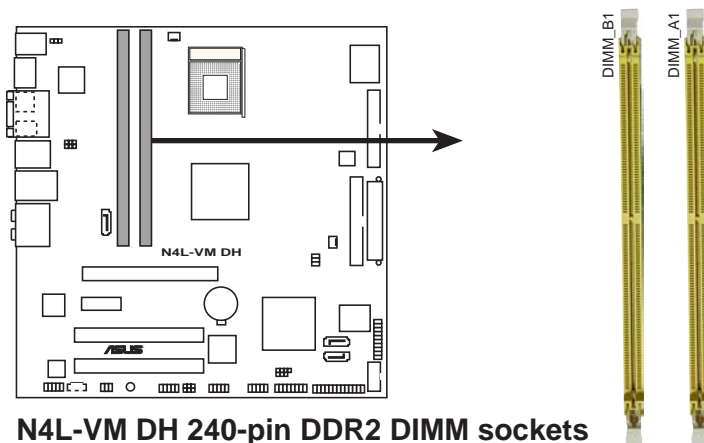

2.4.2 Memory configurations

You may install 256 MB, 512 MB, and 1 GB non-ECC unbuffered DDR2 DIMMs into the DIMM sockets.



- Always install DIMMs with the same CAS latency. For optimum compatibility, we recommend that you obtain memory modules from the same vendor. Refer to the DDR2 Qualified Vendors List on the next page for details.
- This motherboard does not support memory modules made up of 2048 Mb chips or double sided x16 memory modules.

Qualified Vendors Lists (QVL)

DDR2-667 MHz capability

Size	Vendor	Chip No.	Brand	Side(s)	Component	DIMM support		
						CL	A	B
512 MB	KINGSTON	E5108AE-6E-E	-	SS	KVR667D2N5/512	-		
1024 MB	KINGSTON	E5108AE-6E-E	-	DS	KVR667D2N5/1G	-		
512 MB	KINGSTON	E5108AE-6E-E	-	SS	KVR667D2E5/512	-		
256 MB	KINGSTON	HYB18T256800AF3	-	SS	KVR667D2N5/256	-		
256 MB	SAMSUNG	K4T56083QF-ZCE6	-	SS	M378T3253FZ0-CE6	-		
512 MB	SAMSUNG	K4T56083QF-ZCE6	-	DS	M378T6453FZ0-CE6	-		
256 MB	SAMSUNG	K4T56083QF-ZCE6(ECC)	-	SS	M391T3253FZ0-CE6	-		
512 MB	SAMSUNG	K4T56083QF-ZCE6(ECC)	-	DS	M391T6453FZ0-CE6	-		
256 MB	SAMSUNG	K4T51163QC-ZCE6	-	SS	M378T3354CZ0-CE6	-	•	•
512 MB	SAMSUNG	ZCE6K4T51083QC	-	SS	M378T6553CZ0-CE6	-		
1024 MB	SAMSUNG	ZCE6K4T51083QC	-	DS	M378T2953CZ0-CE6	-		
512 MB	MICRON	4VB41D9CZM	-	DS	MT16HTF6464AY-667B4	-	•	•
256 MB	Infineon	HYB18T512160AF-3S	-	SS	HYS64T32000HU-3S-A	-		
512 MB	Infineon	HYB18T512800AF3S	-	SS	HYS64T64000HU-3S-A	-		
1024 MB	Infineon	HYB18T512800AF3S	-	DS	HYS64T128020HU-3S-A	-	•	•
256 MB	Infineon	HYB18T256800AF3S(ECC)	-	SS	HYS72T32000HU-3S-A	-		
512 MB	Infineon	HYB18T512800AF3S(ECC)	-	SS	HYS72T64000HU-3S-A	-		
1024 MB	Infineon	HYB18T512800AF3S(ECC)	-	DS	HYS72T128020HU-3S-A	-		
512 MB	Hynix	HY5PS12821AFP-Y5	-	SS	HYMP564U64AP8-Y5	-		
1024 MB	Hynix	HY5PS12821AFP-Y5	-	DS	HYMP512U64AP8-Y5	-	•	•
1024 MB	Hynix	HY5PS1G831FP-Y5(ECC)	-	SS	HYMP112U72P8-Y5	-		
512 MB	Hynix	HY5PS12821AFP-Y5(ECC)	-	SS	HYMP564U72AP8-Y5	-		
1024 MB	Hynix	HY5PS12821AFP-Y5(ECC)	-	DS	HYMP512U72AP8-Y5	-		
512 MB	Hynix	HY5PS12821AFP-Y4	-	SS	HYMP564U64AP8-Y4	-	•	•
1024 MB	Hynix	HY5PS12821AFP-Y4	-	DS	HYMP512U64AP8-Y4	-	•	•
512 MB	Hynix	HY5PS12821AFP-Y4(ECC)	-	SS	HYMP564U72AP8-Y4	-		
1024 MB	Hynix	HY5PS12821AFP-Y4(ECC)	-	DS	HYMP512U72AP8-Y4	-		
256 MB	ELPIDA	E2508AB-GE-E	-	SS	EBE25UC8ABFA-6E-E	-		
512 MB	ELPIDA	E5108AE-GE-E	-	SS	EBE51UD8AEFA-6E-E	-	•	•
1024 MB	ELPIDA	Engineering Sample	-	DS	EBE11UD8AEFA-6E-E	-	•	•
512 MB	crucial	Heat-Sink Package	-	DS	BL6464AA664.16FB	-		
1024 MB	crucial	Heat-Sink Package	-	DS	BL12864AA664.16FA	-		
512 MB	crucial	Heat-Sink Package	-	DS	BL6464AL664.16FB	-	•	•
1024 MB	crucial	Heat-Sink Package	-	DS	BL12864AL664.16FA	-		
512 MB	Kingmax	E5108AE-6E-E	-	SS	KLCC28F-A8EB5	-	•	•
1024 MB	Kingmax	E5108AE-6E-E	-	DS	KLCD48F-A8EB5	-	•	•
512 MB	Apacer	E5108AE-6E-E	-	SS	78.91092.420	-	•	•
1024 MB	Apacer	E5108AE-6E-E	-	DS	78.01092.420	-	•	•
512 MB	A-DATA	E5108AE-6E-E	-	SS	M20EL5G3H3160B1C0Z	-		
512 MB	TwinMOS	E5108AE-GE-E	-	SS	8G-25JK5-EBT	-		
512 MB	GEIL	Heat-Sink Package	-	SS	GX21GB5300UDC	-		

(Continued on the next page)

DDR2-667 MHz capability

Size	Vendor	Model	Brand	Side(s)	Component	DIMM support		
						CL	A	B
512 MB	GEIL	Heat-Sink Package	-	SS	GX21GB5300DC			
256 MB	NANYA	NT5TU32M16AG-3C	-	SS	NT256T64UH4A0FY-3C			
512 MB	NANYA	NT5TU64M8AE-3C	-	SS	NT512T64U88A0BY-3C			
512 MB	Elixir	N2TU51280AF-3C	-	SS	M2U51264TU88A0F-3C			
1024 MB	Elixir	N2TU51280AF-3C	-	DS	M2U1G64TU8HA2F-3C			
512 MB	OCZ	Heat-Sink Package	-	SS	OCZ26671024EBDCPE-K			
1024 MB	OCZ	Heat-Sink Package	-	DS	OCZ26672048EBDCPE-K			
1024 MB	PQI	E5108AE-5C-E	-	DS	MEAD-403LA			
512 MB	WINTEC	4UAI2D9CRZ	-	SS	39127282			
1024 MB	WINTEC	4WAIID9CWX	-	DS	39137282			
512 MB	MDT	18D51280D-30518	-	SS	M512-667-8			
1024 MB	MDT	18D51280D-30528	-	DS	M924-667-16			
512 MB	Kingbox	DD2640800-667	-	SS	N/A			
1024 MB	Kingbox	DD2640800-667	-	DS	N/A			

Side(s): **SS** - Single-sided **DS** - Double-sided

DIMM support:

- A** - Supports one module inserted into either slot, in Single-channel memory configuration.
- B** - Supports one pair of modules inserted into both slots as one pair of Dual-channel memory configuration.



Visit the ASUS website for the latest DDR2-667 MHz QVL.

DDR2-533 MHz capability

Size	Vendor	Part No.	Brand	Side(s)	Chip No.	DIMM support		
						CL	A	B
256 MB	KINGSTON	E5116AB-5C-E	-	SS	KVR533D2N4/256			
512 MB	KINGSTON	HYS5S56821F-C4	-	DS	KVR533D2N4/512			
1024 MB	KINGSTON	D6408TE7BL-37	-	DS	KVR533D2N4/1G			
2048 MB	KINGSTON	E1108AA-5C-E	-	DS	KVR533D2N4/2G			
512 MB	SAMSUNG	K4T51083QB-GCD5	-	SS	M378T6553BG0-CD5			
256 MB	SAMSUNG	K4T56083QF-GCD5	-	SS	M378T3253FG0-CD5			
512 MB	SAMSUNG	K4T56083QF-GCD5	-	DS	M378T6453FG0-CD5			
512 MB	SAMSUNG	K4T56083QF-GCD5(ECC)	-	DS	M391T6453FG0-CD5			
1024 MB	SAMSUNG	K4T51083QB-GCD5(ECC)	-	DS	M391T2953BG0-CD5			
256 MB	MICRON	4DBII29BQT	-	SS	-			
512 MB	Infineon	HYB18T512800AF3(ECC)	-	SS	HYS72T64000HU-3.7-A			
512 MB	Infineon	HYB18T512800AC37	-	SS	HYS64T64000GU-3.7-A			
256 MB	Infineon	HYB18T512160AF-3.7	-	SS	HYS64T32000HU-3.7-A			

(Continued on the next page)

DDR2-533 MHz capability

Size	Vendor	Part No.	Brand	Side(s)	Chip No.	DIMM support		
						CL	A	B
512 MB	Infineon	HYB18T512800AF37	-	SS	HYS64T64000HU-3.7-A	-	•	•
1024 MB	Infineon	HYB18T512800AF37	-	DS	HYS64T128020HU-3.7-A	-		
2048 MB	Infineon	HYB18T1G800AF-3.7	-	DS	HYS64T256020HU-3.7-A	-		
256 MB	Infineon	HYB18T5121608BF-3.7	-	SS	HYS64T32000HU-3.7-B	-		
512 MB	Infineon	HYB18T512800BF37	-	SS	HYS64T64000HU-3.7-B	-		
1024 MB	Infineon	HYB18T512800BF37	-	DS	HYS64T128020HU-3.7-B	-		
512 MB	Hynix	HY5PS12821F-C4	-	SS	HYMP564U648-C4	-		
512 MB	Hynix	HY5PS12821F-C4(ECC)	-	SS	HYMP564U728-C4	-		
1024 MB	Hynix	HY5PS12821F-C4	-	DS	HYMP512U648-C4	-		
1024 MB	Hynix	HY5PS12821F-C4(ECC)	-	DS	HYMP512U728-C4	-		
1024 MB	Hynix	HY5PS12821F-E3(ECC)	-	DS	HYMP512U728-C4	-		
512 MB	Hynix	HY5PS12821FP-C4(ECC)	-	SS	HYMP564U728-C4	-		
1024 MB	Hynix	HY5PS12821FP-C4	-	DS	HYMP512U648-C4	-	•	•
512 MB	Hynix	HY5PS12821AFP-C3	-	SS	HYMP564U64AP8-C3	-	•	•
1024 MB	Hynix	HY5PS12821AFP-C3	-	DS	HYMP512U64AP8-C3	-		
512 MB	ELPIDA	E5108AB-5C-E(ECC)	-	SS	EBE51ED8ABFA-5C-E	-		
512 MB	ELPIDA	E5108AB-5C-E	-	SS	EBE51UD8ABFA-5C	-		
512 MB	ELPIDA	E5108AB-5C-E	-	SS	EBE51UD8ABFA-5C-E	-	•	•
1024 MB	ELPIDA	E5108AB-5C-E	-	DS	EBE11UD8ABFA-5C-E	-		
2048 MB	ELPIDA	E1108AA-5C-E	-	DS	EBE21EE8AAFA-5C-E	-		
256 MB	CORSAIR	MIII0051832M8CEC	-	SS	VS256MB533D2	-		
512 MB	CORSAIR	M110052432M8CEC	-	DS	VS512MB533D2	-		
256 MB	Apacer	E5116AB-5C-E	-	SS	78.81077.420	-		
256 MB	KINGMAX	E5116AB-5C-E	-	SS	KLBB68F-36EP4	-		
512 MB	KINGMAX	E5108AE-5C-E	-	SS	KLBC28F-A8EB4	-	•	•
1024 MB	KINGMAX	E5108AE-5C-E	-	DS	KLBD48F-A8EB4	-		
512 MB	Transcend	K4T51083QB-GCD5	-	SS	TS64MLQ64V5J	-		
1024 MB	Transcend	K4T51083QB-GCD5	-	DS	TS128MLQ64V5J	-	•	•
256 MB	CENTURY	K4T56083QF-GCD5	-	SS	25V6S8SSD5F4-K43	-		
512 MB	CENTURY	E5108AB-5C-E	-	SS	25V2H8EL5CB4-J43	-		
1024 MB	CENTURY	E5108AB-5C-E	-	DS	25VOH8EL5CB4-J45	-		
1024 MB	CENTURY	E5108AB-5C-E	-	DS	25VOH8EL5C	-		
256 MB	elixir	N2TU51216AF-37B	-	SS	M2U25664TUH4A0F-37B	-		
512 MB	elixir	N2TU51280AF-37B	-	SS	M2U51264TU88A0F-37B	-		
256 MB	Aeneon	AET960UD00-37C88X	-	SS	AET560UD00-370A98X	-		
512 MB	Aeneon	AET960UD00-37C88X	-	SS	AET660UD00-370A98X	-		
512 MB	Aeneon	AET93F370AG0513	-	SS	AET660UD00-370A98X	-		
256 MB	Aeneon	AET94F370A	-	SS	AET560UD00-370A98Z	-		
256 MB	Aeneon	AET94F370A	-	SS	AET560UD00-370A98X	-		
512 MB	Aeneon	AET93F370A	-	SS	AET660UD00-370A98Z	-		
512 MB	Aeneon	AET93F370A	-	SS	AET660UD00-370A98X	-		
512 MB	Aeneon	AET93F370	-	SS	AET660UD00-370A98X	-		

(Continued on the next page)

DDR2-533 MHz capability

Size	Vendor	Part No.	Brand	Side(s)	Chip No.	DIMM support		
						CL	A	B
1024 MB	Aeneon	AET93F370A	-	DS	AET760UD00-370A98X			
256 MB	NANYA	NT5TU32M16AF-37B	-	SS	NT256T64UH4A0F-37B			
512 MB	NANYA	NT5TU64M8AF-37B	-	SS	NT512T64U88A0F-37B			
512 MB	NANYA	NT5TU64M8AF-37B(ECC)	-	SS	NT512T72U89A0F-37B			
1024 MB	NANYA	NT5TU64M8AF-37B	-	DS	NT1GT64U8HA0F-37B			
1024 MB	PQI	64MX8D2-E	-	DS	MEAB-323LA			
512 MB	PQI	64MX8D2-E	-	SS	MEAB-423LA			
512 MB	TwinMOS	K4T51083QB-GCD5	-	SS	8D-22JB5-K2T			
256 MB	SimpleTech	858S032F25A	-	SS	SVM-42DR2/256			
512 MB	SimpleTech	858S064F25A	-	DS	SVM-42DR2/512			
1024 MB	Patriot	Heat-Sink Package	-	SS	PDC21G5600+XBLK			
512 MB	MDT	18D51280D-3.70S20	-	SS	M512-533-8			
1024 MB	MDT	18D51280D-3.70448	-	DS	M924-533-16			

Side(s): **SS** - Single-sided **DS** - Double-sided

DIMM support:

- A** - Supports one module inserted into either slot, in Single-channel memory configuration.
- B** - Supports one pair of modules inserted into both slots as one pair of Dual-channel memory configuration.



Visit the ASUS website for the latest DDR2-533 MHz QVL.

2.4.3 Installing a DIMM



Unplug the power supply before adding or removing DIMMs or other system components. Failure to do so can cause severe damage to both the motherboard and the components.

To install a DIMM:

1. Unlock a DIMM socket by pressing the retaining clips outward.
2. Align a DIMM on the socket such that the notch on the DIMM matches the break on the socket.
3. Firmly insert the DIMM into the socket until the retaining clips snap back in place and the DIMM is properly seated.

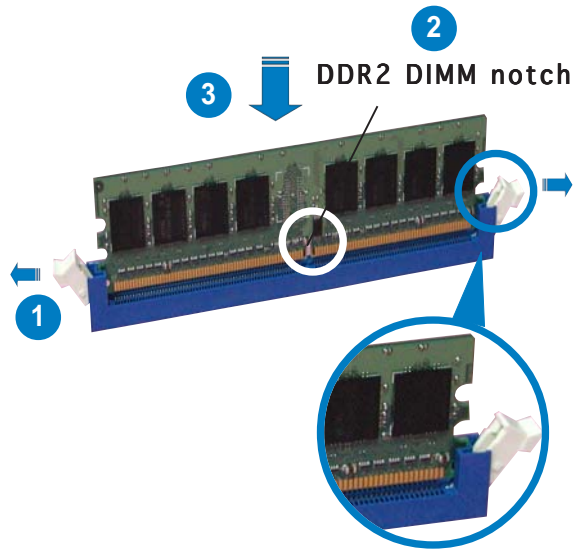

Unlocked retaining clip



- A DDR2 DIMM is keyed with a notch so that it fits in only one direction. Do not force a DIMM into a socket to avoid damaging the DIMM.
- The DDR2 DIMM sockets do not support DDR DIMMs. DO not install DDR DIMMs to the DDR2 DIMM sockets.

2.4.4 Removing a DIMM

To remove a DIMM:

1. Simultaneously press the retaining clips outward to unlock the DIMM.



Support the DIMM lightly with your fingers when pressing the retaining clips. The DIMM might get damaged when it flips out with extra force.

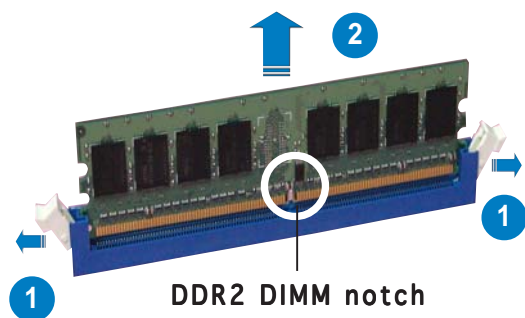

2. Remove the DIMM from the socket.

2.5 Expansion slots

In the future, you may need to install expansion cards. The following sub-sections describe the slots and the expansion cards that they support.



Make sure to unplug the power cord before adding or removing expansion cards. Failure to do so may cause you physical injury and damage motherboard components.

2.5.1 Installing an expansion card

To install an expansion card:

1. Before installing the expansion card, read the documentation that came with it and make the necessary hardware settings for the card.
2. Remove the system unit cover (if your motherboard is already installed in a chassis).
3. Remove the bracket opposite the slot that you intend to use. Keep the screw for later use.
4. Align the card connector with the slot and press firmly until the card is completely seated on the slot.
5. Secure the card to the chassis with the screw you removed earlier.
6. Replace the system cover.

2.5.2 Configuring an expansion card

After installing the expansion card, configure the it by adjusting the software settings.

1. Turn on the system and change the necessary BIOS settings, if any. See Chapter 4 for information on BIOS setup.
2. Assign an IRQ to the card. Refer to the tables on the next page.
3. Install the software drivers for the expansion card.



When using PCI cards on shared slots, ensure that the drivers support “Share IRQ” or that the cards do not need IRQ assignments. Otherwise, conflicts will arise between the two PCI groups, making the system unstable and the card inoperable. Refer to the table on the next page for details.

2.5.3 Interrupt assignments

Standard interrupt assignments

IRQ	Priority	Standard Function
0	1	System Timer
1	2	Keyboard Controller
2	—	Re-direct to IRQ#9
3	11	IRQ holder for PCI steering*
4	12	Communications Port (COM1)*
5	13	IRQ holder for PCI steering*
6	14	Floppy Disk Controller
7	15	Printer Port (LPT1)*
8	3	System CMOS/Real Time Clock
9	4	IRQ holder for PCI steering*
10	5	IRQ holder for PCI steering*
11	6	IRQ holder for PCI steering*
12	7	PS/2 Compatible Mouse Port*
13	8	Numeric Data Processor
14	9	Primary IDE Channel
15	10	Secondary IDE Channel

* These IRQs are usually available for ISA or PCI devices.

IRQ assignments for this motherboard

	A	B	C	D	E	F	G	H
IDE	—	—	shared	—	—	—	—	—
Southbridge Serial ATA	—	—	—	shared	—	—	—	—
USB 0	—	—	—	—	—	—	—	shared
USB 1	—	—	—	shared	—	—	—	—
USB 2	—	—	shared	—	—	—	—	—
USB 3	shared	—	—	—	—	—	—	—
USB 2.0	—	—	—	—	—	—	—	shared
PCIE	shared	—	—	—	—	—	—	—
PCI 1	—	—	—	—	—	shared	—	—
PCI 2	—	—	—	—	—	—	used	—
IEEE 1394	—	—	—	—	—	shared	—	—
JMB363 Serial ATA	—	—	shared	—	—	—	—	—
Intel® LAN	—	—	—	shared	—	—	—	—
Audio	—	used	—	—	—	—	—	—
Internal graphics display (IGD)	shared	—	—	—	—	—	—	—

2.5.4 PCI slots

The PCI slots support cards such as a LAN card, SCSI card, USB card, and other cards that comply with PCI specifications. The figure shows a LAN card installed on a PCI slot.

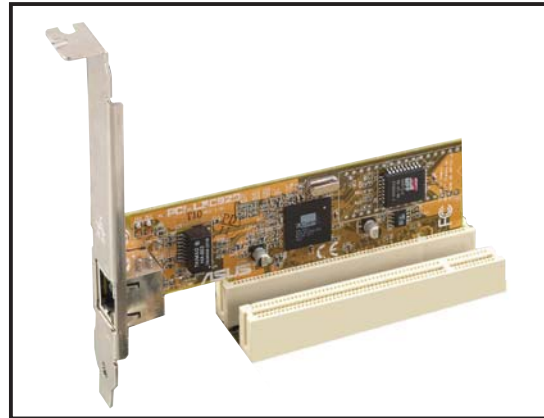

2.5.5 PCI Express x1 slot

This motherboard supports PCI Express x1 network cards, SCSI cards and other cards that comply with the PCI Express specifications. The following figure shows a network card installed on the PCI Express x1 slot.

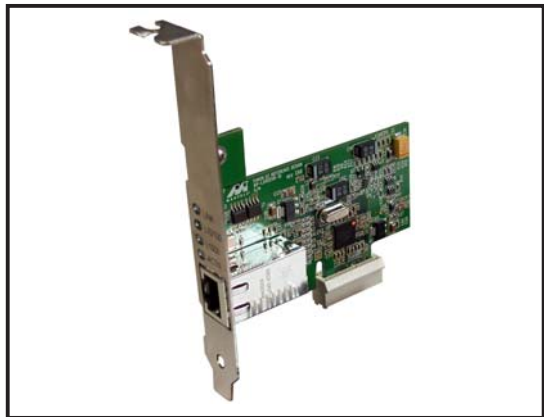

2.5.6 PCI Express x16 slot

This motherboard supports PCI Express x16 graphic cards that comply with the PCI Express specifications.

The figure above shows a graphics card installed on the PCI Express x16 slot.

This motherboard supports an ASUS R-DVI-ADD2 card for DVI output. The figure below shows an R-DVI-ADD2 card installed on the PCI Express x16 slot. Refer to the description and installation instructions on the next page.

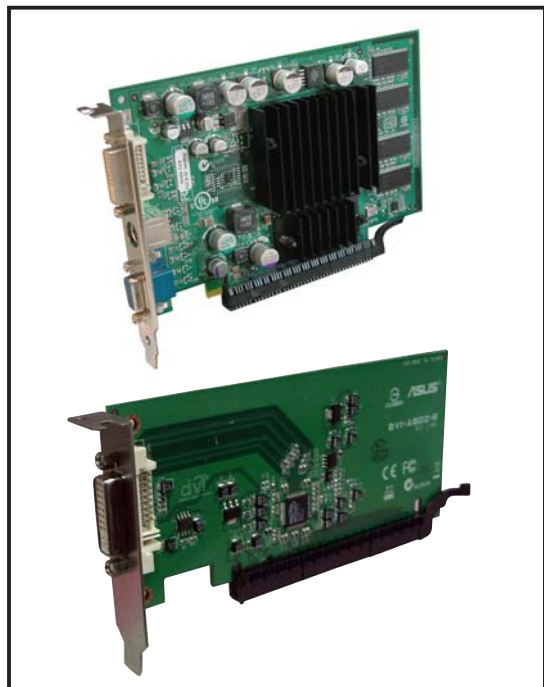

R-DVI-ADD2/R-DVI-ADD2-L support

The motherboard supports an ASUS R-DVI-ADD2/R-DVI-ADD2-L card, which is especially designed for Intel® Pentium™ 4 systems with Intel® 945GT/945GM chipset and PCI Express x16 slot to support digital visual interface (DVI) output for LCD monitors, flat panel displays, and projectors with DVI capability. The card supports dual screen display with an onboard VGA (video graphics adapter), if available.

The R-DVI-ADD2/R-DVI-ADD2-L card supports:

- Intel® proprietary SDVO technology that provides the display interface for DVI monitors
- LCD hot-plug detection
- Dual-screen with onboard VGA
- Up to 1600x1200 resolution at 60 Hz fresh rate
- Scaleable output bandwidth from 25 to 162 megapixels per second
- Various display modes and resolutions:

VGA	640x480	SXGA	1280x1024
SVGA	800x600	SXGA+	1400x1050
XGA	1024x768	UXGA	1600x1200

Card layout

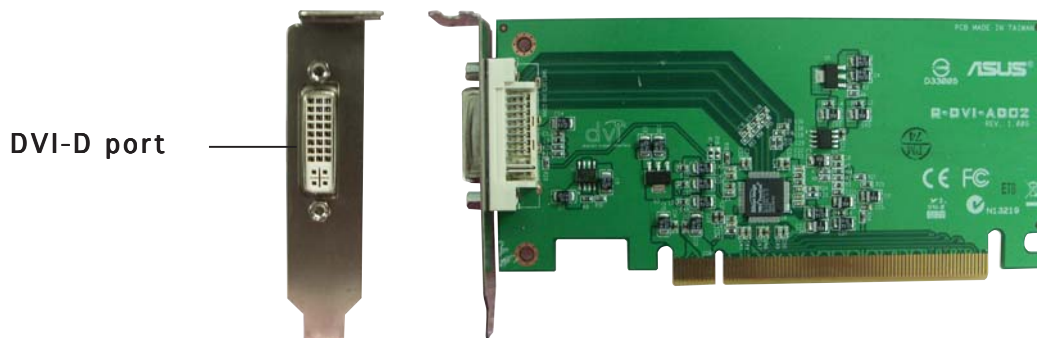

You can adjust the output standard and other graphics configuration using the motherboard BIOS menu. The BIOS options for these configurations may be found in the **Advanced Menu > Chipset > North Bridge Configuration**. Refer section “4.4.3 Chipset” for details.

Card installation



Before installing the R-DVI-ADD2/R-DVI-ADD2-L card, make sure that your system meets the following requirements.

System requirements

- Intel® Pentium™ 4 system with Intel® 945GT/945GM chipset
- Minimum 64 MB system memory
- PCI Express x16 slot
- Windows® 98 SE/ME/2000/XP operating system



The drivers for the R-DVI-ADD2/R-DVI-ADD2-L card are included in the support CD that came with your Intel® 945GT/945GM motherboard. Install the card drivers from the support CD after installing the card to the system.

Installing the card

Follow these steps to install the R-DVI-ADD2/R-DVI-ADD2-L card.



Before handling the card, touch a bare metal portion of your computer to discharge static electricity from your body. Wear a wrist strap grounded to the computer chassis when handling the card.

1. Make sure that the computer is turned off. Unplug the system power cord from the electrical socket.
2. Remove the computer cover, then locate the PCI Express x16 slot. Refer to the motherboard user guide for the slot location.
3. Remove the rear panel bracket opposite the PCI Express x16 slot. Keep the bracket screw for later use.
4. Carefully insert the card to the slot until it fits completely.
5. Secure the card with the screw that you removed earlier.
6. Replace the computer cover, then plug the system power cord to an electrical socket.
7. Connect the display device to the DVI-D port using a DVI-D cable, then turn on the computer.

Enabling DVI display and changing resolutions



All Intel® 945GT/945GM (Grantsdale G) video drivers provided by Intel® have built-in support to enable the ADD2 cards. All the necessary drivers are available from Intel®.

2.6 Jumpers

1. Clear RTC RAM (CLRTC)

This jumper allows you to clear the Real Time Clock (RTC) RAM in CMOS. You can clear the CMOS memory of date, time, and system setup parameters by erasing the CMOS RTC RAM data. The onboard button cell battery powers the RAM data in CMOS, which include system setup information such as system passwords.

To erase the RTC RAM:

1. Turn OFF the computer and unplug the power cord.
2. Remove the onboard battery.
3. Move the jumper cap from pins 1-2 (default) to pins 2-3. Keep the cap on pins 2-3 for about 5~10 seconds, then move the cap back to pins 1-2.
4. Reinstall the battery.
5. Plug the power cord and turn ON the computer.
6. Hold down the key during the boot process and enter BIOS setup to re-enter data.



Except when clearing the RTC RAM, never remove the cap on CLRTC jumper default position. Removing the cap will cause system boot failure!

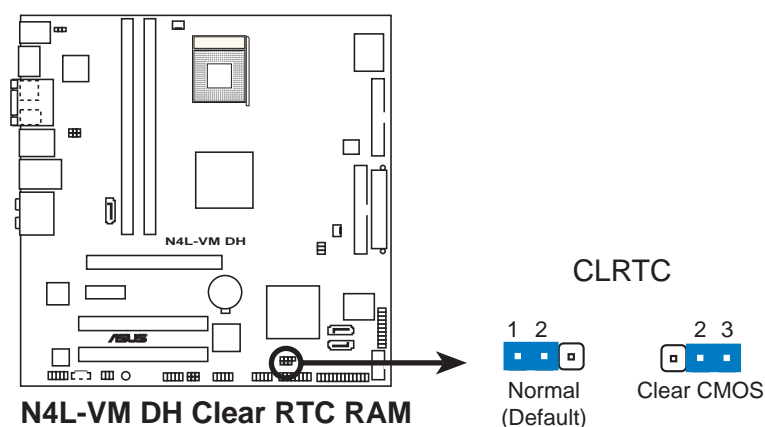

- Make sure to re-enter your previous BIOS settings after you clear the CMOS.
 - You do not need to clear the RTC when the system hangs due to overclocking. For system failure due to overclocking, use the C.P.R. (CPU Parameter Recall) feature. Shut down and reboot the system so the BIOS can automatically reset parameter settings to default values.
-

2. USB device wake-up (3-pin USBPW12, USBPW34, USBPW56, USBPW78)

Set these jumpers to +5V to wake up the computer from S1 sleep mode (CPU stopped, DRAM refreshed, system running in low power mode) using the connected USB devices. Set to +5VSB to wake up from S3 and S4 sleep modes (no power to CPU, DRAM in slow refresh, power supply in reduced power mode).

The USBPW12 and USBPW34 jumpers are for the rear USB ports. The USBPW56 and USBPW78 jumpers are for the internal USB connectors that you can connect to additional USB ports.

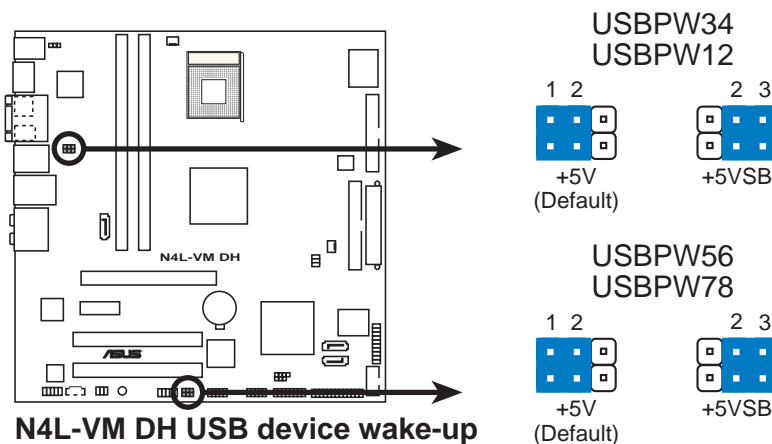

- The USB device wake-up feature requires a power supply that can provide 500mA on the +5VSB lead for each USB device; otherwise, the system will not power up.
- The total current consumed must NOT exceed the power supply capability (+5VSB) whether under normal condition or in sleep mode.

3. Keyboard power (3-pin KBPWR)

This jumper allows you to enable or disable the PS/2 keyboard wake-up feature. Set this jumper to pins 2-3 (+5VSB) to wake up the computer when you press a key on the keyboard (the default is the Space Bar). This feature requires an ATX power supply that can supply at least 1A on the +5VSB lead, and a corresponding setting in the BIOS.

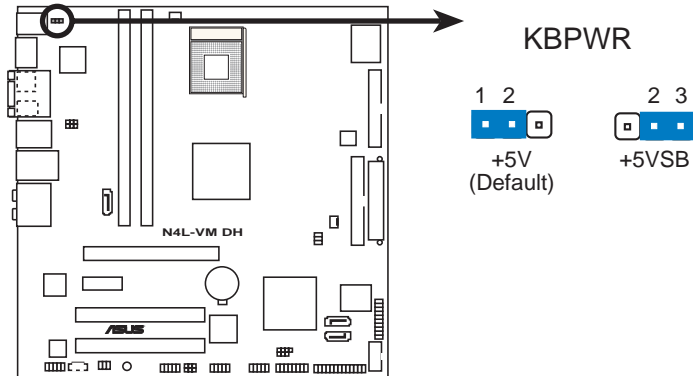

N4L-VM DH Keyboard power setting

2.7 Connectors

2.7.1 Rear panel connectors

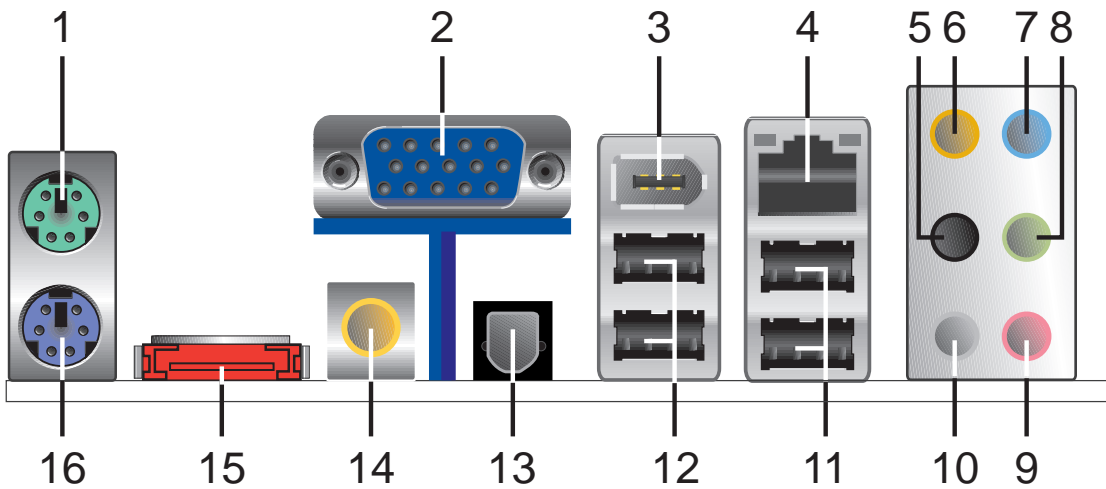

1. **PS/2 mouse port (green).** This port is for a PS/2 mouse.
2. **Video Graphics Adapter port.** This 15-pin port is for a VGA monitor or other VGA-compatible devices.
3. **IEEE 1394a port.** This 6-pin port provides high-speed connectivity for audio/video devices, storage peripherals, PCs, or portable devices.
4. **LAN (RJ-45) port.** This port allows Gigabit connection to a Local Area Network (LAN) through a network hub. Refer to the table below for the LAN port LED indications.

LAN port LED indications

ACT/LINK LED		SPEED LED	
Status	Description	Status	Description
OFF	No link	OFF	10Mbps connection
GREEN	Linked	ORANGE	100Mbps connection
BLINKING	Acting	GREEN	1Gbps connection

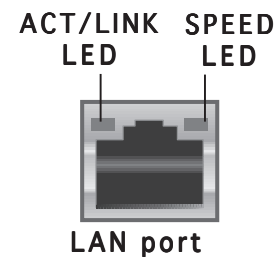

5. **Rear Speaker Out port (black).** This port connects the rear speakers in a 4/6/8-channel audio configuration.
6. **Center/Subwoofer port (orange).** This port connects the center/subwoofer speakers.
7. **Line In port (light blue).** This port connects the tape, CD, DVD player, or other audio sources.
8. **Line Out port (lime).** This port connects a headphone or a speaker. In 4-channel, 6-channel, and 8-channel configuration, the function of this port becomes Front Speaker Out.
9. **Microphone port (pink).** This port connects a microphone.

10. Side Speaker Out port (gray). This port connects the side speakers in an 8-channel audio configuration.



- Refer to the audio configuration table below for the function of the audio ports in 2, 4, 6, or 8-channel configuration.
- See section “5.3.2 Audio configurations” on page 5-11 for details.

Audio 2, 4, 6, or 8-channel configuration

Port	Headset 2-channel	4-channel	6-channel	8-channel
Light Blue	Line In	Line In	Line In	Line In
Lime	Line Out	Front Speaker Out	Front Speaker Out	Front Speaker Out
Pink	Mic In	Mic In	Mic In	Mic In
Black	-	Rear Speaker Out	Rear Speaker Out	Rear Speaker Out
Gray	-	-	-	Side Speaker Out
Orange	-	-	Center/Subwoofer	Center/Subwoofer

- 11. USB 2.0 ports 3 and 4.** These two 4-pin Universal Serial Bus (USB) ports are available for connecting USB 2.0 devices.
- 12. USB 2.0 ports 1 and 2.** These two 4-pin Universal Serial Bus (USB) ports are available for connecting USB 2.0 devices.
- 13. Optical S/PDIF Out port.** This port connects an external audio output device via an optical S/PDIF cable.
- 14. Coaxial S/PDIF Out port.** This port connects an external audio output device via a coaxial S/PDIF cable.
- 15. External SATA port.** This port connects to an external SATA box or a Serial ATA port multiplier.



The external SATA port supports external Serial ATA 1.5 and 3 Gb/s devices. Longer cables support higher power requirements to deliver signal up to two meters away, and enables improved hot-swap function.

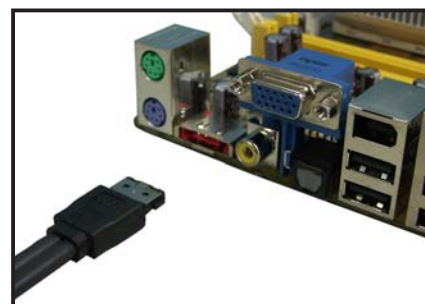

- Do not insert a different connector to this port.
- Do not remove/unplug the external SATA device when running under RAID mode to prevent data loss or damage.

16. PS/2 keyboard port (purple). This port is for a PS/2 keyboard.

2.7.2 Internal connectors

1. Floppy disk drive connector (34-1 pin FLOPPY)

This connector is for the provided floppy disk drive (FDD) signal cable. Insert one end of the cable to this connector, then connect the other end to the signal connector at the back of the floppy disk drive.



Pin 5 on the connector is removed to prevent incorrect cable connection when using a FDD cable with a covered Pin 5.

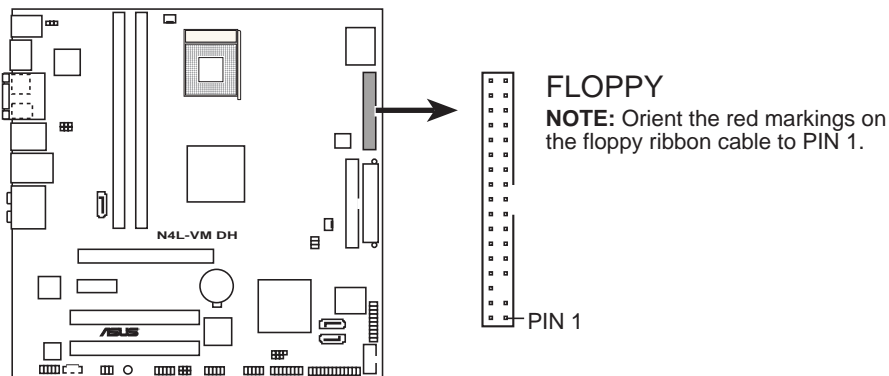

N4L-VM DH Floppy disk drive connector

2. IDE connector (40-1 pin IDE)

This connector is for the Ultra DMA 100 signal cable. The Ultra DMA 100 signal cable has three connectors: a blue connector for the primary IDE connector on the motherboard, a black connector for an Ultra DMA 100 IDE slave device (optical drive/hard disk drive), and a gray connector for an Ultra DMA 100 IDE master device (hard disk drive). If you install two hard disk drives, you must configure the second drive as a slave device by setting its jumper accordingly. Refer to the hard disk documentation for the jumper settings.



-
- Pin 20 on the IDE connector is removed to match the covered hole on the Ultra DMA cable connector. This prevents incorrect insertion when you connect the IDE cable.
 - Use the 80-conductor IDE cable for Ultra DMA 100 IDE devices.
-

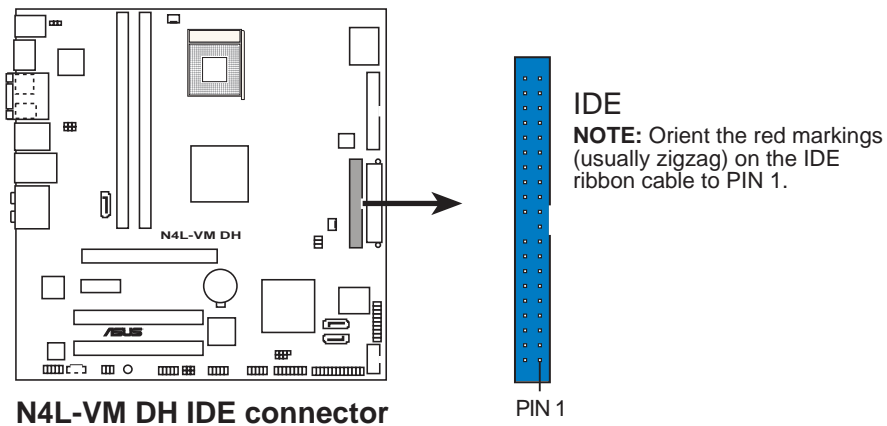

3. Intel® ICH7-M DH Southbridge Serial ATA connectors (7-pin SATA0 [black], SATA2 [black])

These connectors are for the Serial ATA signal cables for Serial ATA I (1.5 Gb/s) hard disk and optical disk drives.

If you installed Serial ATA hard disk drives, you can create a RAID 0, RAID 1, and Intel® Matrix Storage configuration through the onboard Intel® RAID controller. Refer to section “5.4.2 Intel® RAID configurations” for details on how to set up Serial ATA RAID configurations.



The RAID function of these connectors is set to [Disabled] by default. If you intend to create a Serial ATA RAID set using these connectors, set the **Configure SATA As** item in the BIOS to [RAID]. See section “4.3.5 IDE Configuration” for details.

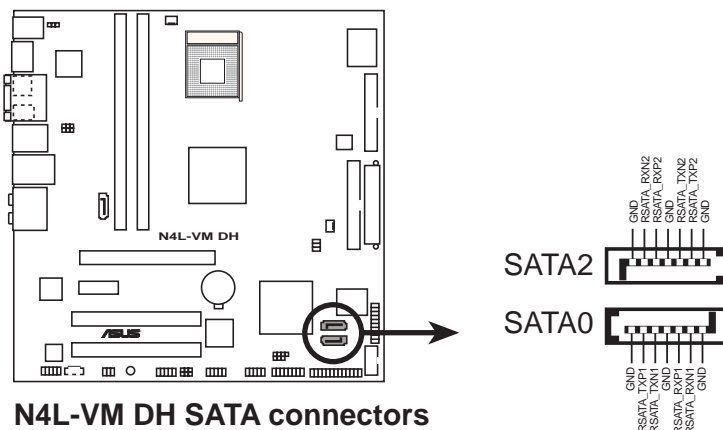

4. JMicron Serial ATA 3.0 Gb/s RAID connector (7-pin SATA_RAID1 [red])

This connector is for a Serial ATA signal cable. It supports a Serial ATA hard disk drive

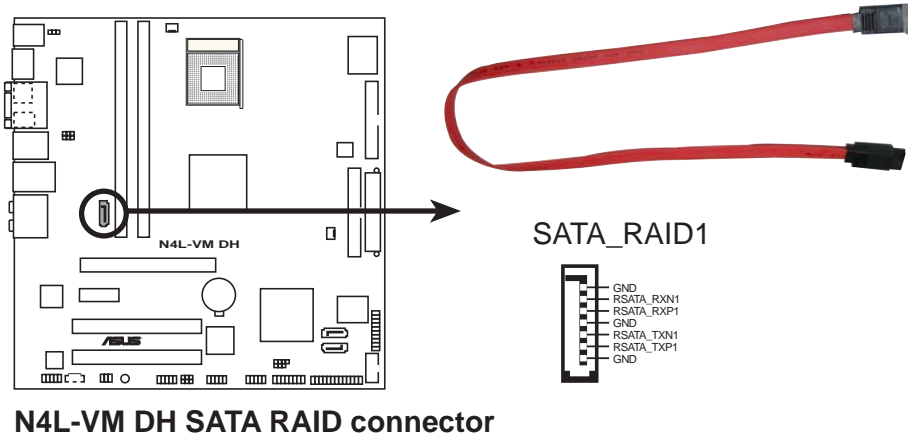

The Serial ATA port multiplier and external Serial ATA box are purchased separately.

5. CD audio in connector (4-pin CD)

This connector is for the 4-pin audio cable that connects to the audio connector at the back of the optical drive.

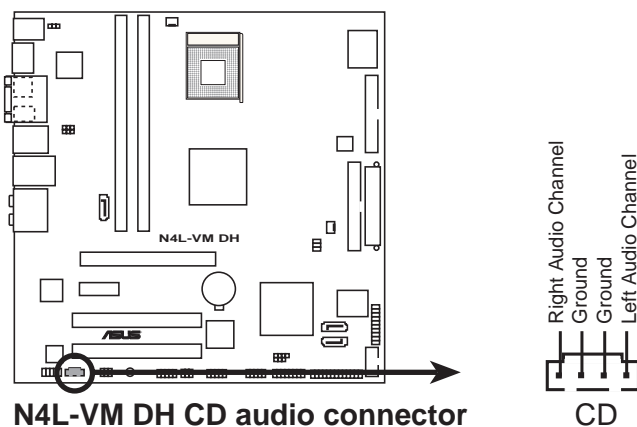

6. USB connectors (10-1 pin USB56, USB78)

These connectors are for USB 2.0 ports. Connect the USB/GAME module cable to any of these connectors, then install the module to a slot opening at the back of the system chassis. These USB connectors comply with USB 2.0 specification that supports up to 480 Mbps connection speed.

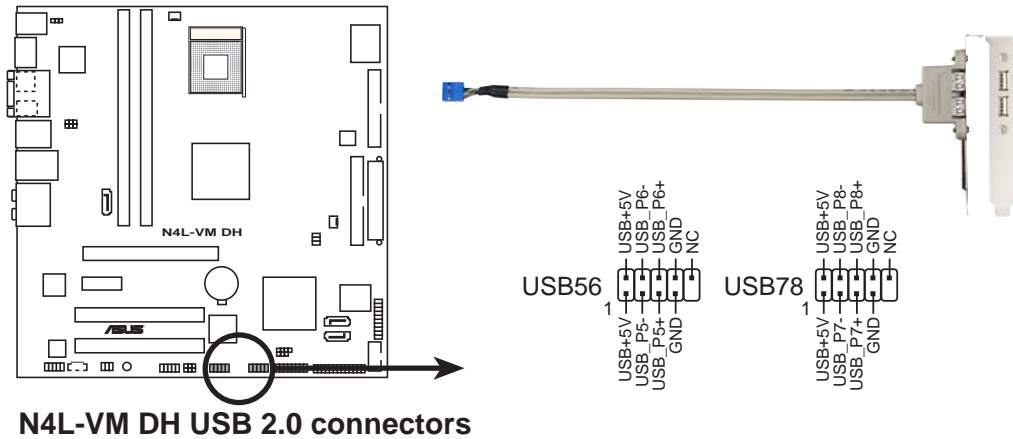

Never connect a **1394 cable** to the USB connectors. Doing so will damage the motherboard!



An external infrared (IR) module will occupy one (1) USB port.

7. Front panel audio connector (10-1 pin AAFP)

This connector is for a chassis-mounted front panel audio I/O module that supports either HD Audio or legacy AC '97 audio standard. Connect one end of the front panel audio I/O module cable to this connector.

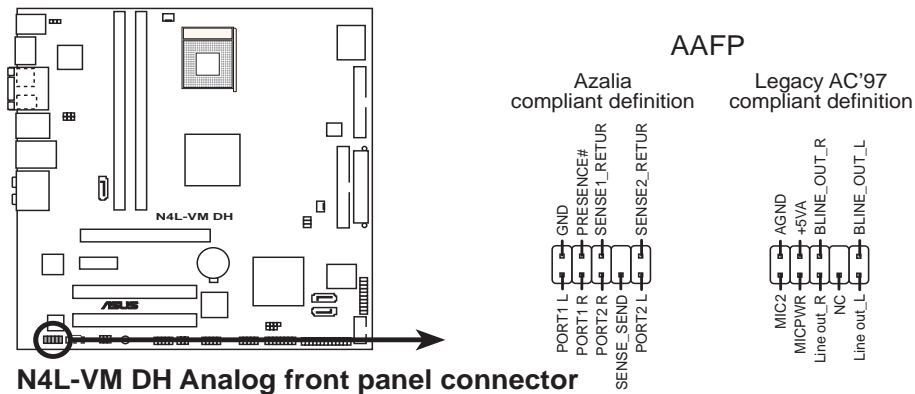

N4L-VM DH Analog front panel connector



- We recommend that you connect a high-definition front panel audio module to this connector to avail of the motherboard's high-definition audio capability.
- By default, this connector is set to legacy AC`97 audio. If you want to connect a high-definition front panel audio module to this connector, set the **Front Panel Support Type** item in the BIOS setup to [Azalia]. See page 4-24 for details.

8. IEEE 1394a port connector (10-1 pin IE1394_2)

This connector is for the IEEE 1394a port. Connect the IEEE 1394 module cable to this connector, then install the module to a slot opening at the back of the system chassis.

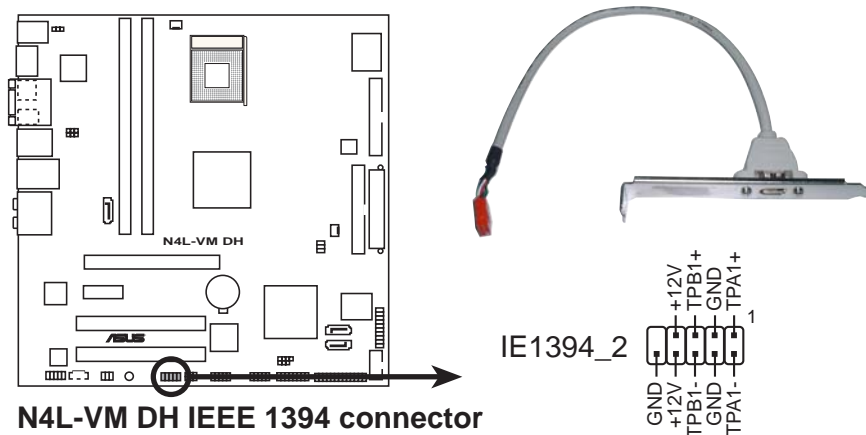

N4L-VM DH IEEE 1394 connector



Never connect a **USB cable** to the IEEE 1394a connectors. Doing so will damage the motherboard!

9. GAME/MIDI port connector (16-1 pin GAME)

This connector is for a GAME/MIDI port. Connect the USB/GAME or GAME/MIDI module cable to this connector, then install the module to a slot opening at the back of the system chassis. The GAME/MIDI port connects a joystick or game pad for playing games, and MIDI devices for playing or editing audio files.

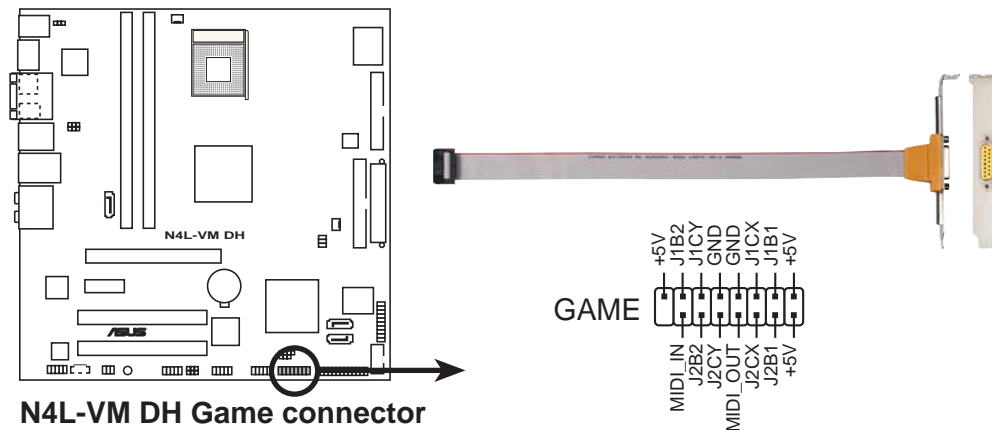

The GAME/MIDI module is purchased separately.

10. Serial port connector (10-1 pin COM1)

This connector is for a serial (COM) port. Connect the serial port module cable to this connector, then install the module to a slot opening at the back of the system chassis.

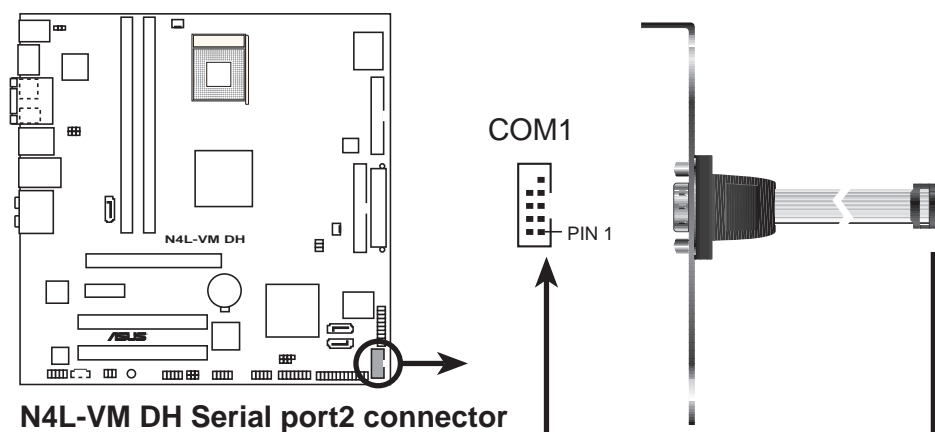

The serial port module is purchased separately.

11. CPU and chassis fan connectors (3-pin CPU_FAN, 3-pin CHA_FAN)

The fan connectors support cooling fans of 350 mA ~ 2000 mA (24 W max.) or a total of 1 A ~ 3.48 A (41.76 W max.) at +12V. Connect the fan cables to the fan connectors on the motherboard, making sure that the black wire of each cable matches the ground pin of the connector.



Do not forget to connect the fan cables to the fan connectors. Insufficient air flow inside the system may damage the motherboard components. These are not jumpers! Do not place jumper caps on the fan connectors!

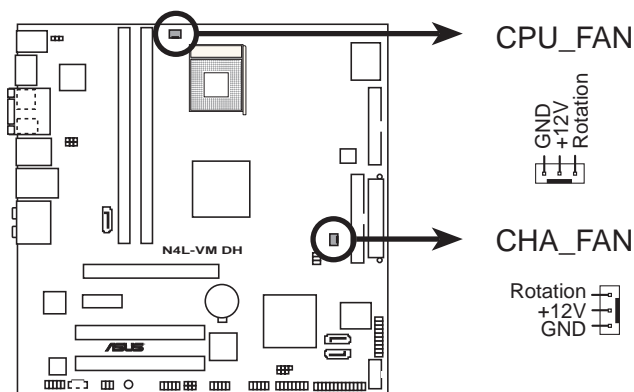

N4L-VM DH Fan connectors

12. Chassis intrusion connector (4-1 pin CHASSIS)

This connector is for a chassis-mounted intrusion detection sensor or switch. Connect one end of the chassis intrusion sensor or switch cable to this connector. The chassis intrusion sensor or switch sends a high-level signal to this connector when a chassis component is removed or replaced. The signal is then generated as a chassis intrusion event.

By default, the pins labeled “Chassis Signal” and “Ground” are shorted with a jumper cap. Remove the jumper caps only when you intend to use the chassis intrusion detection feature.

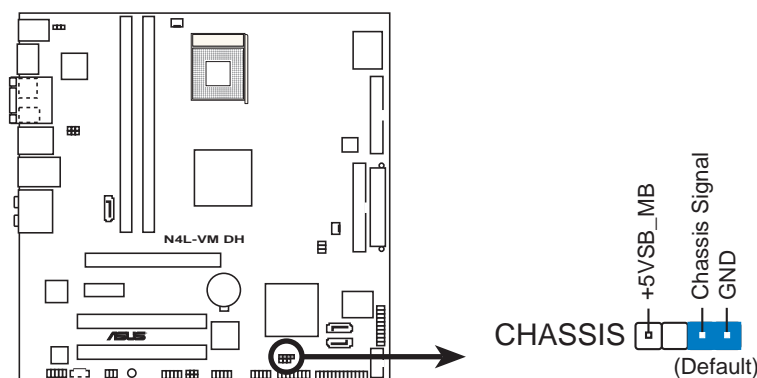

N4L-VM DH Chassis intrusion connector

13. ATX power connectors (24-pin EATXPWR, 4-pin ATX12V)

These connectors are for ATX power supply plugs. The power supply plugs are designed to fit these connectors in only one orientation. Find the proper orientation and push down firmly until the connectors completely fit.

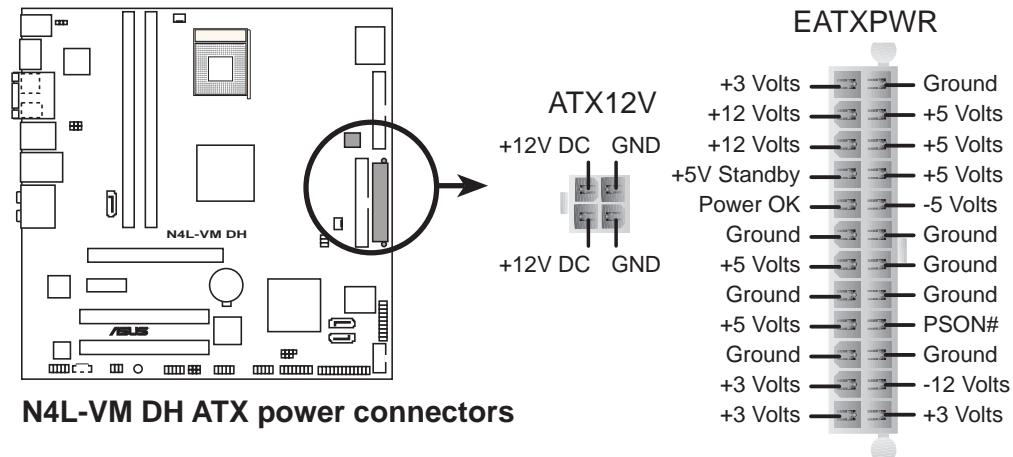

- For a fully configured system, we recommend that you use a power supply unit (PSU) that complies with ATX 12 V Specification 2.0 (or later version).
- Do not forget to connect the 4-pin ATX +12 V power plug; otherwise, the system will not boot.
- Use of a PSU with a higher power output is recommended when configuring a system with more power-consuming devices. The system may become unstable or may not boot up if the power is inadequate.
- Visit www.asus.com for the latest power requirements table.

Power requirements table

	Heavy	Normal	Light
CPU	Intel® Core™ Duo T2600 processor (Dual-Core 2.16 GHz)	Intel® Core™ Duo T2600 processor (Dual-Core 2.16 GHz)	Intel® Core™ Duo T2600 processor (Dual-Core 2.16 GHz)
PCIe16	6600	Onboard Gfx	Onboard Gfx
DDR2-667 DIMMs	2 x 1G	2 x 512M	2 x 512M
SATA IDE	2	2	2
Optical drive (DVD/CD-ROM)	2	2	1
PCIe1 Card	1	0	0
PCI Card	2	1	1
USB	6	4	1
Required +12V_V1 (24 Pin)	>= 10 A	>= 5 A	>= 4 A
Required +12V_V2 (4 Pin)	>= 3 A	>= 3 A	>= 3 A
Required wattage	>250 W	>= 150W	>= 120W



- We recommend that you use a PSU with a higher power output when configuring a system with more power consuming devices.
- Different PCI-E x16 Graphics card requires different +12V_V1 power. To support a high-end PCI-E x16 Graphics card, make sure that the PSU can provide more 12V power on the 12V_V1 lead."

14. Parallel port connector (26-1 pin LPT)

This connector is for a parallel port. Connect the parallel port module cable to this connector, then install the module to a slot opening at the back of the system chassis.

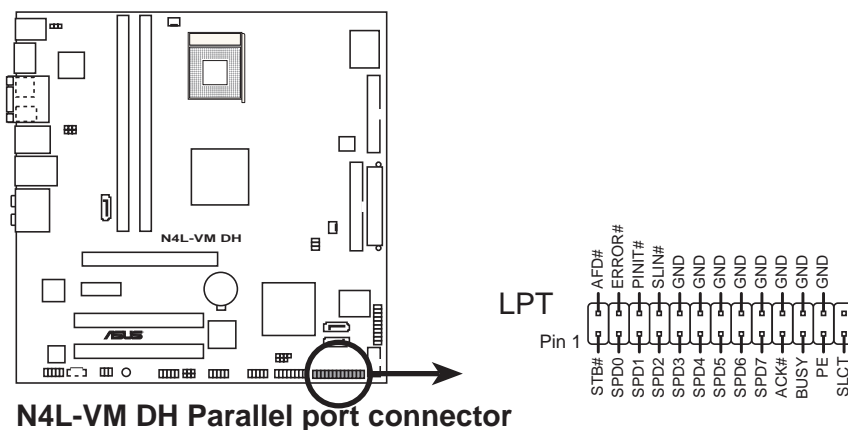

The parallel port cable is purchased separately.

15. S/PDIF In/Out connector (6-1 pin SPDIF)

This connector is for an additional Sony/Philips Digital Interface (S/PDIF) port(s). Connect the S/PDIF In/Out module cable to this connector, then install the module to a slot opening at the back of the system chassis.

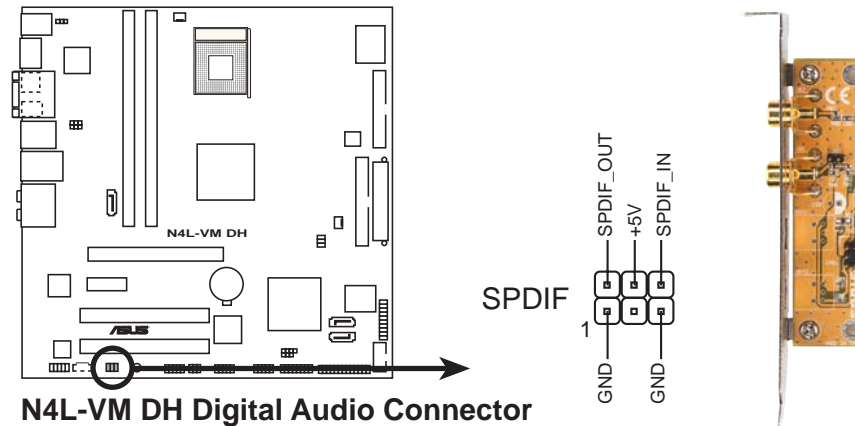

The S/PDIF module is purchased separately.

16. TV Out connector (6-1 pin TV_C)

This 6-1 pin connector is for the front panel daughter card with the audio TV-out port. This connector allows dual display (TV+VGA or TV+DVI) with the ASUS AV/S.

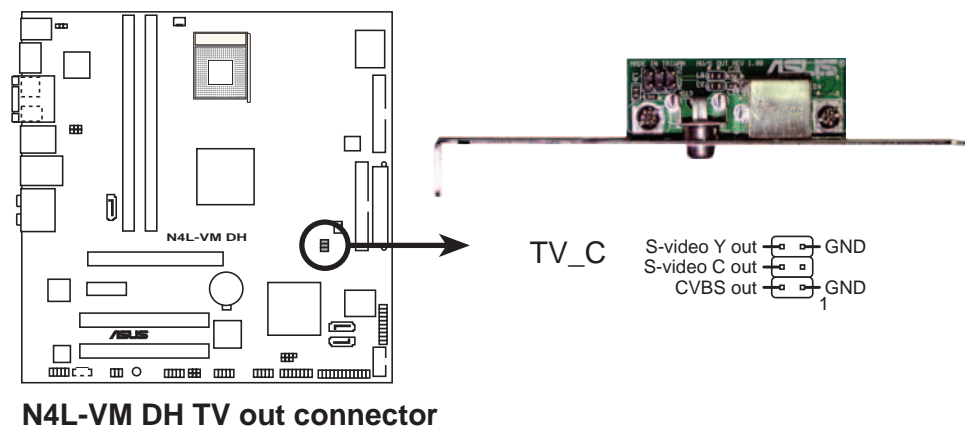

The ASUS AV/S module is purchased separately.



Do not connect the S-Video and composite TV ports simultaneously to prevent abnormal or no display.

17. System panel connector (20-pin PANEL)

This connector supports several chassis-mounted functions.

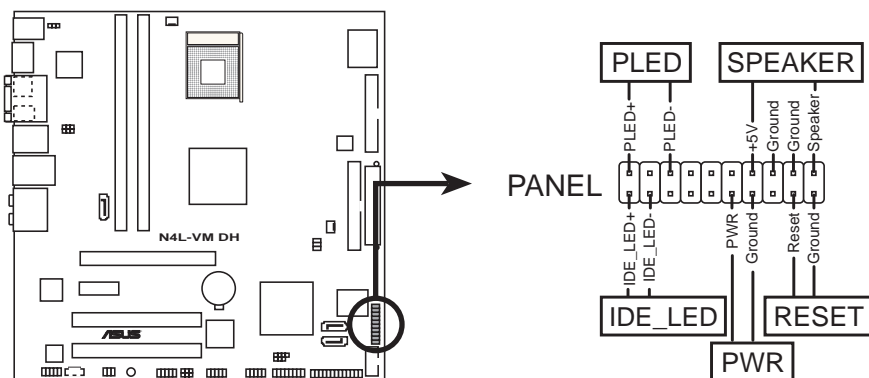

N4L-VM DH System panel connector * Requires an ATX power supply.



The system panel connector is color-coded for easy connection. Refer to the connector description below for details.

- **System power LED (Green 3-pin PLED)**
This 3-pin connector is for the system power LED. Connect the chassis power LED cable to this connector. The system power LED lights up when you turn on the system power, and blinks when the system is in sleep mode.
- **Hard disk drive activity LED (Red 2-pin IDE_LED)**
This 2-pin connector is for the HDD Activity LED. Connect the HDD Activity LED cable to this connector. The IDE LED lights up or flashes when data is read from or written to the HDD.
- **System warning speaker (Orange 4-pin SPEAKER)**
This 4-pin connector is for the chassis-mounted system warning speaker. The speaker allows you to hear system beeps and warnings.
- **ATX power button/soft-off button (Light Green 2-pin PWR)**
This connector is for the system power button. Pressing the power button turns the system on or puts the system in sleep or soft-off mode depending on the BIOS settings. Pressing the power switch for more than four seconds while the system is ON turns the system OFF.
- **Reset button (Blue 2-pin RESET)**
This 2-pin connector is for the chassis-mounted reset button for system reboot without turning off the system power.

This chapter describes the power up sequence, the vocal POST messages, and ways of shutting down the system.

Powering up

Chapter summary

3

3.1	Starting up for the first time	3-1
3.2	Powering off the computer	3-2

3.1 Starting up for the first time

1. After making all the connections, replace the system case cover.
2. Be sure that all switches are off.
3. Connect the power cord to the power connector at the back of the system chassis.
4. Connect the power cord to a power outlet that is equipped with a surge protector.
5. Turn on the devices in the following order:
 - a. Monitor
 - b. External SCSI devices (starting with the last device on the chain)
 - c. System power
6. After applying power, the system power LED on the system front panel case lights up. For systems with ATX power supplies, the system LED lights up when you press the ATX power button. If your monitor complies with “green” standards or if it has a “power standby” feature, the monitor LED may light up or switch between orange and green after the system LED turns on.

The system then runs the power-on self tests or POST. While the tests are running, the BIOS beeps or additional messages appear on the screen. If you do not see anything within 30 seconds from the time you turned on the power, the system may have failed a power-on test. Check the jumper settings and connections or call your retailer for assistance.
7. At power on, hold down the <Delete> key to enter the BIOS Setup. Follow the instructions in Chapter 4.

3.2 Powering off the computer

3.2.1 Using the OS shut down function

If you are using Windows® 2000:

1. Click the **Start** button then click **Shut Down...**
2. Make sure that the **Shut Down** option button is selected, then click the **OK** button to shut down the computer.
3. The power supply should turn off after Windows® shuts down.

If you are using Windows® XP:

1. Click the **Start** button then select **Turn Off Computer.**
2. Click the **Turn Off** button to shut down the computer.
3. The power supply should turn off after Windows® shuts down.

3.2.2 Using the dual function power switch

While the system is ON, pressing the power switch for less than four seconds puts the system to sleep mode or to soft-off mode, depending on the BIOS setting. Pressing the power switch for more than four seconds lets the system enter the soft-off mode regardless of the BIOS setting. Refer to section “4.5 Power Menu” in Chapter 4 for details.

This chapter tells how to change the system settings through the BIOS Setup menus. Detailed descriptions of the BIOS parameters are also provided.

BIOS setup



4.1	Managing and updating your BIOS	4-1
4.2	BIOS setup program	4-11
4.3	Main menu	4-14
4.4	Advanced menu	4-18
4.5	Power menu	4-29
4.6	Boot menu	4-34
4.7	Exit menu	4-38

4.1 Managing and updating your BIOS

The following utilities allow you to manage and update the motherboard Basic Input/Output System (BIOS) setup.

1. **ASUS Update** (Updates the BIOS in Windows® environment.)
2. **ASUS EZ Flash** (Updates the BIOS in DOS mode using a floppy disk or the motherboard support CD.)
3. **ASUS AFUDOS** (Updates the BIOS in DOS mode using a bootable floppy disk.)
4. **ASUS CrashFree BIOS 2** (Updates the BIOS using a bootable floppy disk or the motherboard support CD when the BIOS file fails or gets corrupted.)

Refer to the corresponding sections for details on these utilities.



Save a copy of the original motherboard BIOS file to a bootable floppy disk in case you need to restore the BIOS in the future. Copy the original motherboard BIOS using the ASUS Update or AFUDOS utilities.

4.1.1 ASUS Update utility

The ASUS Update is a utility that allows you to manage, save, and update the motherboard BIOS in Windows® environment. The ASUS Update utility allows you to:

- Save the current BIOS file
- Download the latest BIOS file from the Internet
- Update the BIOS from an updated BIOS file
- Update the BIOS directly from the Internet, and
- View the BIOS version information.

This utility is available in the support CD that comes with the motherboard package.



-
- ASUS Update requires an Internet connection either through a network or an Internet Service Provider (ISP).
 - Quit all Windows® applications before you update the BIOS using this utility.
-

Installing ASUS Update

To install ASUS Update:

1. Place the support CD in the optical drive. The **Drivers** menu appears.
2. Click the **Utilities** tab, then click **ASUS Update**. See page 5-3 for the **Utilities** screen menu.
3. The ASUS Update utility is copied to your system.

Updating the BIOS through the Internet

To update the BIOS through the Internet:

1. Launch the ASUS Update utility from the Windows® desktop by clicking **Start > Programs > ASUS > ASUSUpdate > ASUSUpdate**. The ASUS Update main window appears.

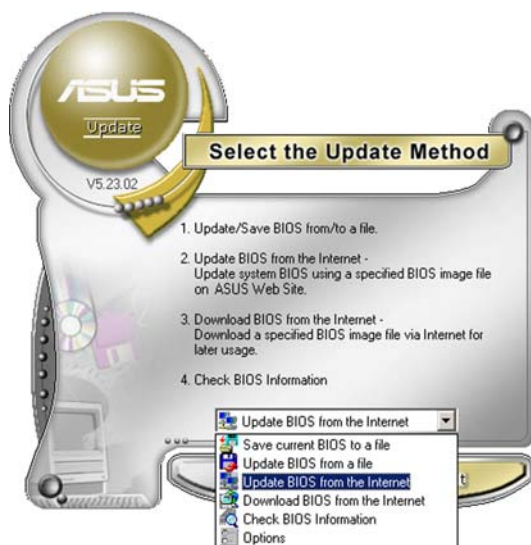
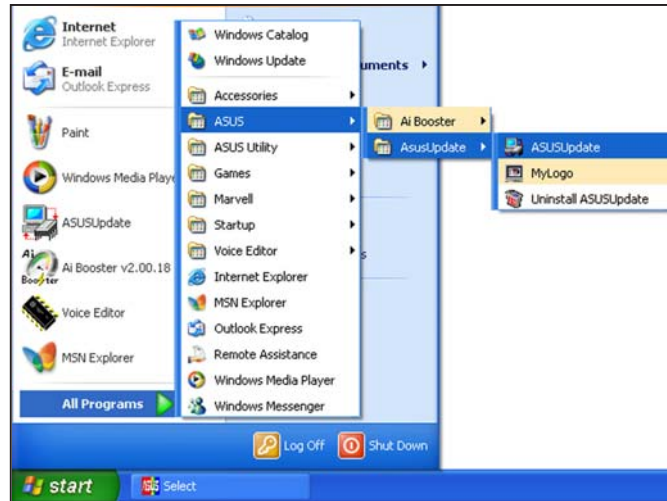

2. Select **Update BIOS from the Internet** option from the drop-down menu, then click **Next**.



3. Select the ASUS FTP site nearest you to avoid network traffic, or click **Auto Select**. Click **Next**.

- From the FTP site, select the BIOS version that you wish to download. Click Next.
- Follow the screen instructions to complete the update process.



The ASUS Update utility is capable of updating itself through the Internet. Always update the utility to avail all its features.



Updating the BIOS through a BIOS file

To update the BIOS through a BIOS file:

- Launch the ASUS Update utility from the Windows® desktop by clicking **Start > Programs > ASUS > ASUSUpdate > ASUSUpdate**. The ASUS Update main window appears.
- Select **Update BIOS from a file** option from the drop-down menu, then click **Next**.

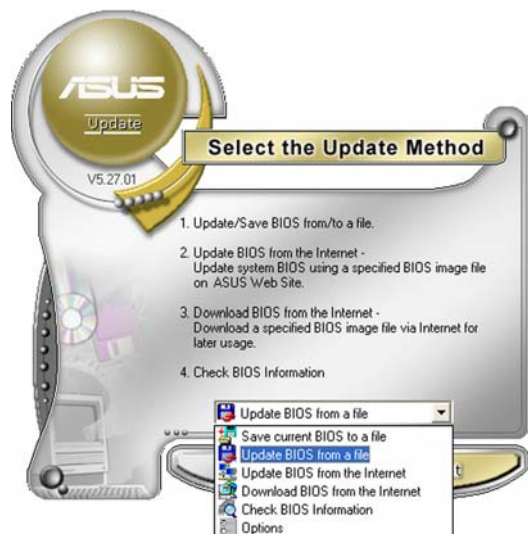

- Locate the BIOS file from the **Open** window, then click **Save**.
- Follow the screen instructions to complete the update process.

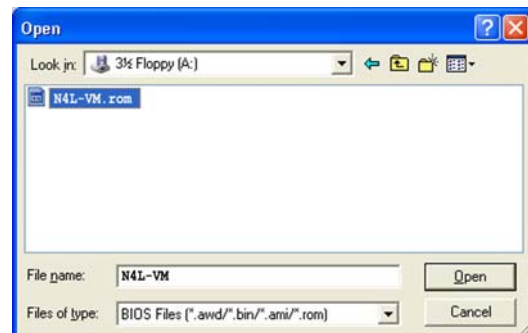

4.1.2 Creating a bootable floppy disk

1. Do either one of the following to create a bootable floppy disk.

DOS environment

- a. Insert a 1.44MB floppy disk into the drive.
- b. At the DOS prompt, type **format A:/S** then press <Enter>.

Windows® XP environment

- a. Insert a 1.44 MB floppy disk to the floppy disk drive.
- b. Click **Start** from the Windows® desktop, then select **My Computer**.
- c. Select the 3 1/2 Floppy Drive icon.
- d. Click **File** from the menu, then select **Format. A Format 3 1/2 Floppy Disk** window appears.
- e. **Windows® XP users:** Select **Create an MS-DOS startup disk** from the format options field, then click **Start**.

Windows® 2000 environment

To create a set of boot disks for Windows® 2000:

- a. Insert a formatted, high density 1.44 MB floppy disk into the drive.
 - b. Insert the Windows® 2000 CD to the optical drive.
 - c. Click **Start**, then select **Run**.
 - d. In the **Open** field, type **D:\bootdisk\makeboot a:** assuming that D is your optical drive letter.
 - e. Press <Enter>, then follow screen instructions to continue.
2. Copy the original or the latest motherboard BIOS file to the bootable floppy disk.

4.1.3 ASUS EZ Flash utility

The ASUS EZ Flash feature allows you to update the BIOS without having to go through the long process of booting from a floppy disk and using a DOS-based utility. The EZ Flash utility is built-in the BIOS chip so it is accessible by pressing <Alt> + <F2> during the Power-On Self Tests (POST).

To update the BIOS using EZ Flash:

1. Visit the ASUS website (www.asus.com) to download the latest BIOS file for the motherboard and rename the same to **N4L-VM.ROM**.
2. Save the BIOS file to a floppy disk, then restart the system.
3. Press <Alt> + <F2> during POST to display the following.

```
EZFlash starting BIOS update...
Checking for floppy...
```

4. Insert the floppy disk that contains the BIOS file to the floppy disk drive. When the correct BIOS file is found, EZ Flash performs the BIOS update process and automatically reboots the system when done.

```
EZFlash starting BIOS update...
Checking for floppy...
Floppy found!
Reading file "N4L-VM.rom". Completed.
Start erasing.....|
Start programming...|
Flashed successfully. Rebooting.
```



- Do not shutdown or reset the system while updating the BIOS to prevent system boot failure!
- A “Floppy not found!” error message appears if there is no floppy disk in the drive. A “N4L-VM.ROM not found!” error message appears if the correct BIOS file is not found in the floppy disk. Make sure that you rename the BIOS file to N4L-VM.ROM.

4.1.4 AFUDOS utility

The AFUDOS utility allows you to update the BIOS file in DOS environment using a bootable floppy disk with the updated BIOS file. This utility also allows you to copy the current BIOS file that you can use as backup when the BIOS fails or gets corrupted during the updating process.

Copying the current BIOS

To copy the current BIOS file using the AFUDOS utility:



- Make sure that the floppy disk is not write-protected and has at least 1.2 MB free space to save the file.
- The succeeding BIOS screens are for reference only. The actual BIOS screen displays may not be same as shown.

1. Copy the AFUDOS utility (afudos.exe) from the motherboard support CD to the bootable floppy disk you created earlier.
2. Boot the system in DOS mode, then at the prompt type:

```
afudos /o[filename]
```

where the [filename] is any user-assigned filename not more than eight alphanumeric characters for the main filename and three alphanumeric characters for the extension name.

```
A:\>afudos /oOLDBIOS1.rom
```

Main filename Extension name

3. Press <Enter>. The utility copies the current BIOS file to the floppy disk.

```
A:\>afudos /oOLDBIOS1.rom
AMI Firmware Update Utility - Version 1.19(ASUS V2.07(03.11.24BB))
Copyright (C) 2002 American Megatrends, Inc. All rights reserved.
  Reading flash ..... done
  Write to file..... ok
A:\>
```

The utility returns to the DOS prompt after copying the current BIOS file.

Updating the BIOS file

To update the BIOS file using the AFUDOS utility:

1. Visit the ASUS website (www.asus.com) and download the latest BIOS file for the motherboard. Save the BIOS file to a bootable floppy disk.



Write the BIOS filename on a piece of paper. You need to type the exact BIOS filename at the DOS prompt.

2. Copy the AFUDOS utility (afudos.exe) from the motherboard support CD to the bootable floppy disk you created earlier.
3. Boot the system in DOS mode, then at the prompt type:

```
afudos /i[filename]
```

where [filename] is the latest or the original BIOS file on the bootable floppy disk.

```
A:\>afudos /iN4L-VM.rom
```

4. The utility verifies the file and starts updating the BIOS.

```
A:\>afudos /iN4L-VM.rom
AMI Firmware Update Utility - Version 1.19 (ASUS V2.07(03.11.24BB))
Copyright (C) 2002 American Megatrends, Inc. All rights reserved.

WARNING!! Do not turn off power during flash BIOS
Reading file ..... done
Reading flash ..... done

Advance Check .....
Erasing flash ..... done
Writing flash ..... 0x0008CC00 (9%)
```



Do not shut down or reset the system while updating the BIOS to prevent system boot failure!

5. The utility returns to the DOS prompt after the BIOS update process is completed. Reboot the system from the hard disk drive.

```
A:\>afudos /iN4L-VM.rom
AMI Firmware Update Utility - Version 1.19(ASUS V2.07(03.11.24BB))
Copyright (C) 2002 American Megatrends, Inc. All rights reserved.

WARNING!! Do not turn off power during flash BIOS
Reading file ..... done
Reading flash ..... done

Advance Check .....
Erasing flash ..... done
Writing flash ..... done
Verifying flash .... done

Please restart your computer

A:\>
```

4.1.5 ASUS CrashFree BIOS 2 utility

The ASUS CrashFree BIOS 2 is an auto recovery tool that allows you to restore the BIOS file when it fails or gets corrupted during the updating process. You can update a corrupted BIOS file using the motherboard support CD or the floppy disk that contains the updated BIOS file.



- Prepare the motherboard support CD or the floppy disk containing the updated motherboard BIOS before using this utility.
- Make sure that you rename the original or updated BIOS file in the floppy disk to **N4L-VM.ROM**.

Recovering the BIOS from a floppy disk

To recover the BIOS from a floppy disk:

1. Turn on the system.
2. Insert the floppy disk with the original or updated BIOS file to the floppy disk drive.
3. The utility displays the following message and automatically checks the floppy disk for the original or updated BIOS file.

```
Bad BIOS checksum. Starting BIOS recovery...  
Checking for floppy...
```

When found, the utility reads the BIOS file and starts flashing the corrupted BIOS file.

```
Bad BIOS checksum. Starting BIOS recovery...  
Checking for floppy...  
Floppy found!  
Reading file "N4L-VM.ROM". Completed.  
Start programming...
```



DO NOT shut down or reset the system while updating the BIOS! Doing so can cause system boot failure!

4. Restart the system after the utility completes the updating process.

Recovering the BIOS from the support CD

To recover the BIOS from the support CD:

1. Remove any floppy disk from the floppy disk drive, then turn on the system.
2. Insert the support CD to the optical drive.
3. The utility displays the following message and automatically checks the floppy disk for the original or updated BIOS file.

```
Bad BIOS checksum. Starting BIOS recovery...
Checking for floppy...
```

When no floppy disk is found, the utility automatically checks the optical drive for the original or updated BIOS file. The utility then updates the corrupted BIOS file.

```
Bad BIOS checksum. Starting BIOS recovery...
Checking for floppy...
Floppy not found!
Checking for CD-ROM...
CD-ROM found!
Reading file "N4L-VM.ROM". Completed.
Start programming...
```



DO NOT shut down or reset the system while updating the BIOS! Doing so can cause system boot failure!

4. Restart the system after the utility completes the updating process.



The recovered BIOS may not be the latest BIOS version for this motherboard. Visit the ASUS website (www.asus.com) to download the latest BIOS file.

4.2 BIOS setup program

This motherboard supports a programmable firmware chip that you can update using the provided utility described in section “4.1 Managing and updating your BIOS.”

Use the BIOS Setup program when you are installing a motherboard, reconfiguring your system, or prompted to “Run Setup.” This section explains how to configure your system using this utility.

Even if you are not prompted to use the Setup program, you can change the configuration of your computer in the future. For example, you can enable the security password feature or change the power management settings. This requires you to reconfigure your system using the BIOS Setup program so that the computer can recognize these changes and record them in the CMOS RAM or the firmware hub.

The firmware hub on the motherboard stores the Setup utility. When you start up the computer, the system provides you with the opportunity to run this program. Press during the Power-On-Self-Test (POST) to enter the Setup utility; otherwise, POST continues with its test routines.

If you wish to enter Setup after POST, restart the system by pressing <Ctrl+Alt+Delete>, or by pressing the reset button on the system chassis. You can also restart by turning the system off and then back on. Do this last option only if the first two failed.

The Setup program is designed to make it as easy to use as possible. Being a menu-driven program, it lets you scroll through the various sub-menus and make your selections from the available options using the navigation keys.



-
- The default BIOS settings for this motherboard apply for most conditions to ensure optimum performance. If the system becomes unstable after changing any BIOS settings, load the default settings to ensure system compatibility and stability. Select the **Load Default Settings** item under the Exit Menu. See section “4.7 Exit Menu.”
 - The BIOS setup screens shown in this section are for reference purposes only, and may not exactly match what you see on your screen.
 - Visit the ASUS website (www.asus.com) to download the latest BIOS file for this motherboard.
-

4.2.1 BIOS menu screen

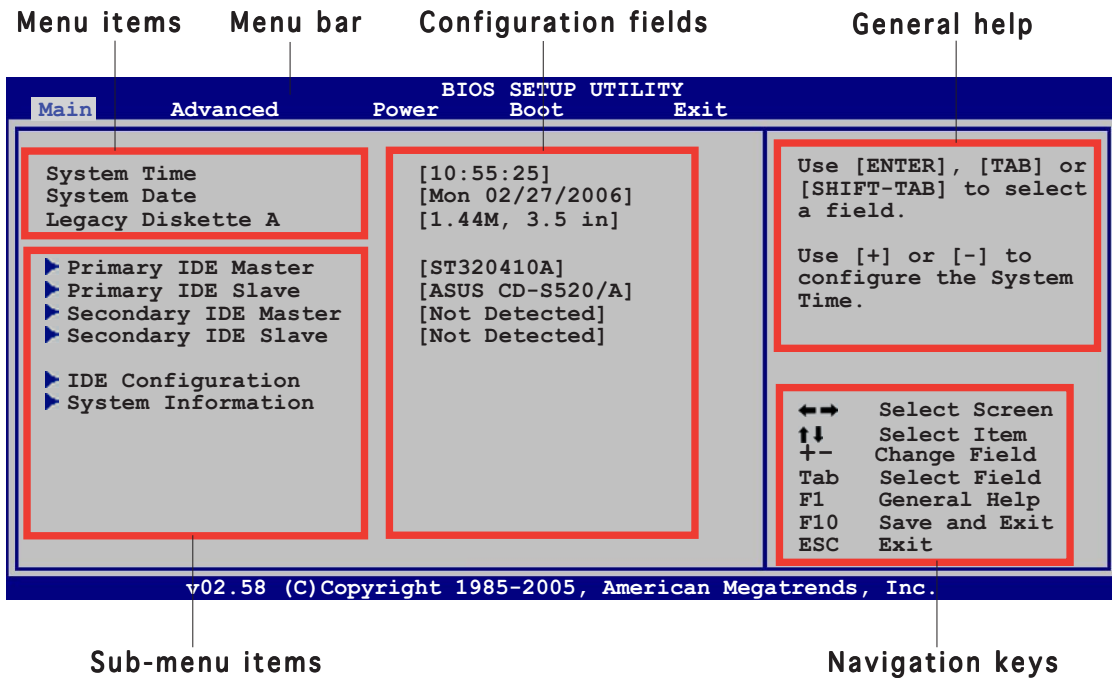

4.2.2 Menu bar

The menu bar on top of the screen has the following main items:

- Main** For changing the basic system configuration
- Advanced** For changing the advanced system settings
- Power** For changing the advanced power management (APM) configuration
- Boot** For changing the system boot configuration
- Exit** For selecting the exit options and loading default settings

To select an item on the menu bar, press the right or left arrow key on the keyboard until the desired item is highlighted.

4.2.3 Navigation keys

At the bottom right corner of a menu screen are the navigation keys for that particular menu. Use the navigation keys to select items in the menu and change the settings.



Some of the navigation keys differ from one screen to another.

4.2.4 Menu items

The highlighted item on the menu bar displays the specific items for that menu. For example, selecting **Main** shows the Main menu items.

The other items (Advanced, Power, Boot, and Exit) on the menu bar have their respective menu items.

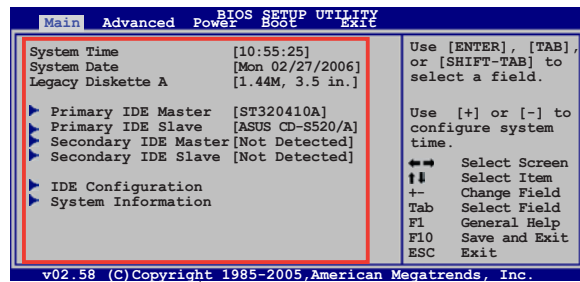

Main menu items

4.2.5 Sub-menu items

A solid triangle before each item on any menu screen means that the item has a sub-menu. To display the sub-menu, select the item and press <Enter>.

4.2.6 Configuration fields

These fields show the values for the menu items. If an item is user-configurable, you can change the value of the field opposite the item. You cannot select an item that is not user-configurable.

A configurable field is enclosed in brackets, and is highlighted when selected. To change the value of a field, select it then press <Enter> to display a list of options. Refer to “4.2.7 Pop-up window.”

4.2.7 Pop-up window

Select a menu item then press <Enter> to display a pop-up window with the configuration options for that item.

4.2.8 Scroll bar

A scroll bar appears on the right side of a menu screen when there are items that do not fit on the screen. Press the Up/Down arrow keys or <Page Up> /<Page Down> keys to display the other items on the screen.

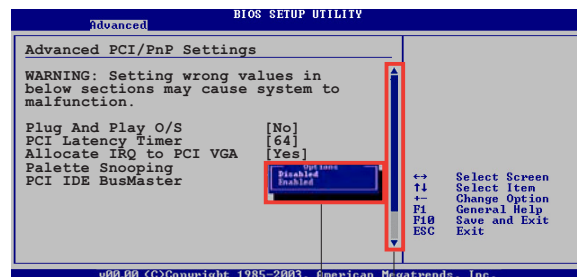

Pop-up window

Scroll bar

4.2.9 General help

At the top right corner of the menu screen is a brief description of the selected item.

4.3 Main menu

When you enter the BIOS Setup program, the **Main** menu screen appears, giving you an overview of the basic system information.



Refer to section “4.2.1 BIOS menu screen” for information on the menu screen items and how to navigate through them.

```

BIOS SETUP UTILITY
Main  Advanced  Power  Boot  Exit
-----
System Time           [10:55:25]
System Date           [Mon 02/27/2006]
Legacy Diskette A     [1.44M, 3.5 in]

▶ Primary IDE Master  [ST320410A]
▶ Primary IDE Slave   [ASUS CD-S520/A]
▶ Secondary IDE Master [Not Detected]
▶ Secondary IDE Slave [Not Detected]

▶ IDE Configuration
▶ System Information

Use [ENTER], [TAB] or
[SHIFT-TAB] to select
a field.

Use [+] or [-] to
configure the System
Time.

←→ Select Screen
↑↓ Select Item
+- Change Field
Tab Select Field
F1  General Help
F10 Save and Exit
ESC Exit

v02.58 (C) Copyright 1985-2005, American Megatrends, Inc.
```

4.3.1 System Time [xx:xx:xx]

Allows you to set the system time.

4.3.2 System Date [Day xx/xx/xxxx]

Allows you to set the system date.

4.3.3 Legacy Diskette A [1.44M, 3.5 in.]

Sets the type of floppy drive installed. Configuration options: [Disabled]
[360K, 5.25 in.] [1.2M, 5.25 in.] [720K, 3.5 in.] [1.44M, 3.5 in.]
[2.88M, 3.5 in.]

4.3.4 Primary and Secondary IDE Master/Slave

The BIOS automatically detects the connected IDE devices. There is a separate sub-menu for each IDE device. Select a device item, then press <Enter> to display the IDE device information.

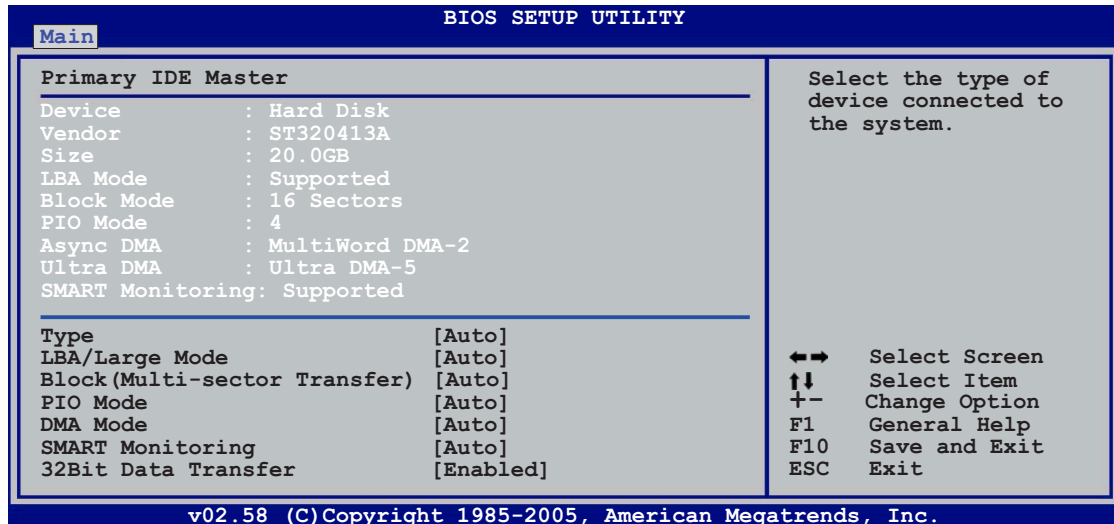

The BIOS automatically detects the values opposite the dimmed items (Device, Vendor, Size, LBA Mode, Block Mode, PIO Mode, Async DMA, Ultra DMA, and SMART monitoring). These values are not user-configurable. These items show N/A if no IDE device is installed in the system.

Type [Auto]

Selects the type of IDE drive. Setting to [Auto] allows automatic selection of the appropriate IDE device type. Select [CDROM] if you are specifically configuring a CD-ROM drive. Select [ARMD] (ATAPI Removable Media Device) if your device is either a ZIP, LS-120, or MO drive. Configuration options: [Not Installed] [Auto] [CDROM] [ARMD]

LBA/Large Mode [Auto]

Enables or disables the LBA mode. Setting to [Auto] enables the LBA mode if the device supports this mode, and if the device was not previously formatted with LBA mode disabled. Configuration options: [Disabled] [Auto]

Block (Multi-sector Transfer) [Auto]

Enables or disables data multi-sectors transfers. When set to [Auto], the data transfer from and to the device occurs multiple sectors at a time if the device supports multi-sector transfer feature. When set to [Disabled], the data transfer from and to the device occurs one sector at a time. Configuration options: [Disabled] [Auto]

PIO Mode [Auto]

Selects the PIO mode.

Configuration options: [Auto] [0] [1] [2] [3] [4]

DMA Mode [Auto]

Selects the DMA mode. Configuration options: [Auto] [SWDMA0] [SWDMA1] [SWDMA2] [MWDMA0] [MWDMA1] [MWDMA2] [UDMA0] [UDMA1] [UDMA2] [UDMA3] [UDMA4] [UDMA5]

SMART Monitoring [Auto]

Sets the Smart Monitoring, Analysis, and Reporting Technology.

Configuration options: [Auto] [Disabled] [Enabled]

32Bit Data Transfer [Enabled]

Enables or disables 32-bit data transfer.

Configuration options: [Disabled] [Enabled]

4.3.5 IDE configuration

The items in this menu allow you to set or change the configurations for IDE devices. Select an item, then press <Enter> to configure.

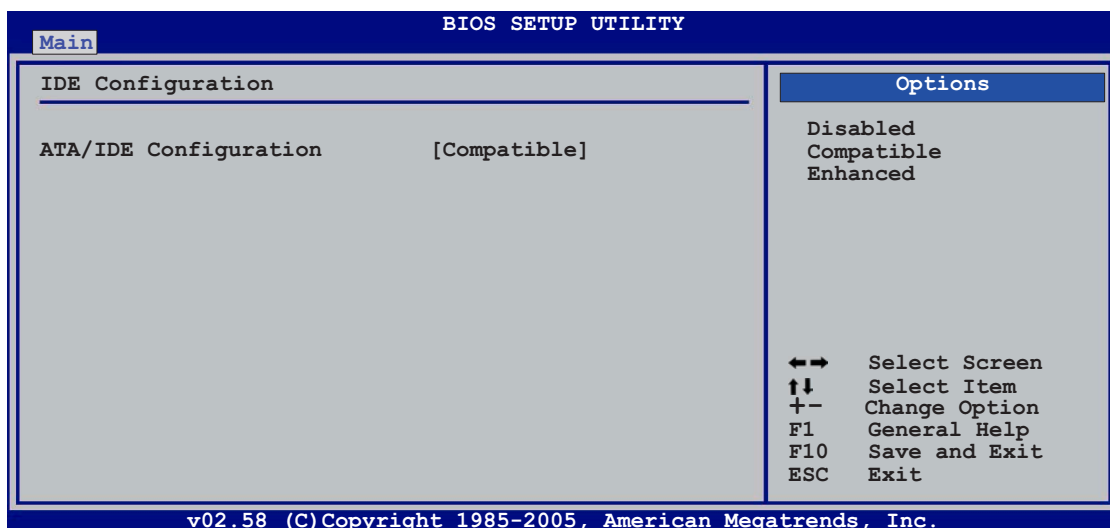

ATA/IDE Configuration [Compatible]

Allows selection of the IDE operation mode depending on the operating system (OS) that you installed. Set to Enhanced if you are using native OS, such as Windows® 2000/XP. Configuration options: [Disabled] [Compatible] [Enhanced]



The following item appears if you set the **ATA/IDE Configuration** item to [Enhanced].

Configure SATA as [IDE]

Sets the Serial ATA configuration. When set in Advanced Host Controller Interface (AHCI) or RAID mode, the SATA controller is set to Native mode. Configuration options: [IDE] [RAID] [AHCI]

4.3.6 System Information

This menu gives you an overview of the general system specifications. The BIOS automatically detects the items in this menu.

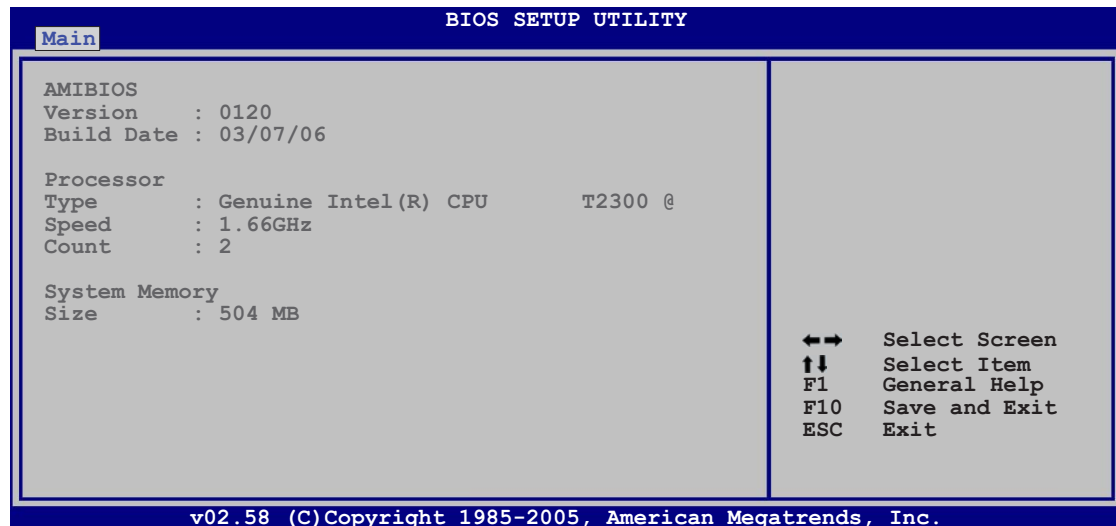

AMI BIOS

Displays the auto-detected BIOS information.

Processor

Displays the auto-detected CPU specification.

System Memory

Displays the auto-detected system memory.

4.4 Advanced menu

The Advanced menu items allow you to change the settings for the CPU and other system devices.



Take caution when changing the settings of the Advanced menu items. Incorrect field values can cause the system to malfunction.

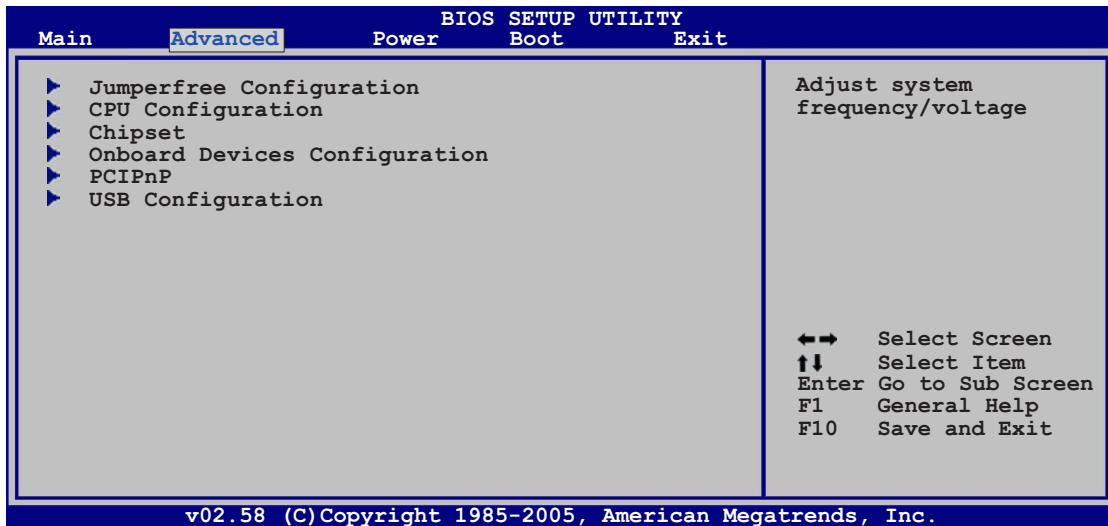

4.4.1 JumperFree Configuration

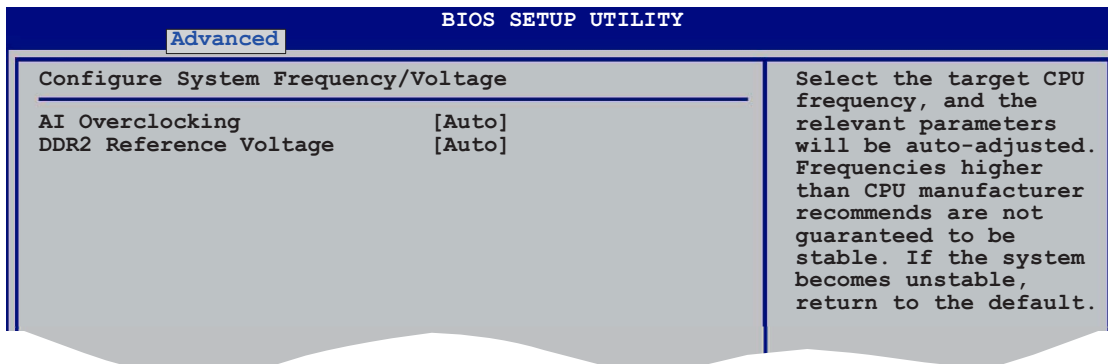

AI Overclocking [Auto]

Allows you to select the overclocking options to achieve the desired CPU internal frequency. Select either one of the preset overclocking configuration options.

Manual - allows you to individually set overclocking parameters.

Auto - loads the optimal settings for the system.



The following two items appear only when you set the **AI Overclocking** item to [Manual].

CPU Frequency [166]

Displays the frequency set by the clock generator to the system bus and PCI bus. The value of this item is auto-detected by the BIOS. Use the <+> or <-> keys to adjust the CPU frequency. You can also type the desired CPU frequency using the numeric keypad. The values range from 100 ~ 500.

CPU Clock Spread Spectrum [Default]

Allows you to enable or disable the CPU clock spread spectrum. Configuration options: [Default] [+/- 0.25%] [+/- 0.35%] [+/- 0.40%]... [+/- 1.00%]

DDR2 Reference Voltage [Auto]

Allows you to select the DDR2 reference voltage. Configuration options: [1.80V] [1.90V] [2.00V] [2.10V]



Refer to the DDR2 documentation before adjusting the memory voltage. Setting a very high memory voltage may damage the memory module(s)!

4.4.2 CPU Configuration

The items in this menu show the CPU-related information that the BIOS automatically detects.

```
BIOS SETUP UTILITY
Advanced
Configure Advanced CPU settings
Module Version: 3C.0F
Manufacturer: Intel
Brand String: Genuine Intel(R) CPU T2300
Frequency : 1.66 GHz
FSB Speed : 667 MHz
Cache L1 : 32 KB
Cache L2 : 2048 KB
Ratio Status: Unlocked (Max:10, Min:6)
Ratio Actual Value : 10
Max CPUID Value Limit: [Disabled]
Vanderpool Technology: [Enabled]
Execute Disable Bit [Enabled]
Intel(R) SpeedStep(tm) tech. [Automatic]
Intel(R) C-STATE tech [Enabled]
Disabled for Windows XP.
←→ Select Screen
↑↓ Select Item
+- Change Option
F1 General Help
F10 Save and Exit
ESC Exit
v02.58 (C) Copyright 1985-2005, American Megatrends, Inc.
```

Max CPUID Value Limit [Disabled]

Setting this item to [Enabled] allows legacy operating systems to boot even without support for CPUs with extended CPUID functions.

Configuration options: [Disabled] [Enabled]

Execute Disable Bit [Enabled]

Allows you to enable or disable the No-Execution Page Protection Technology. Setting this item to [Enabled] forces the XD feature flag to always return to zero (0). Configuration options: [Disabled] [Enabled]

Intel(R) SpeedStep(tm) tech. [Automatic]

Allows you to use the Enhanced Intel SpeedStep® Technology. When set to [Automatic], you can adjust the system power settings in the operating system to use the EIST feature.

Set this item to [Disabled] if you do not want to use the EIST.

Configuration options: [Automatic] [Disabled]



- Refer to the Appendix for details on how to use the EIST feature.
- The motherboard comes with a BIOS file that supports EIST.

Intel(R) C-STATE tech. [Enabled]

Allows you to enable or disable the Intel® C-State technology feature.

Configuration options: [Disabled] [Enabled]

4.4.3 Chipset

The Chipset menu allows you to change the advanced chipset settings. Select an item then press <Enter> to display the sub-menu.

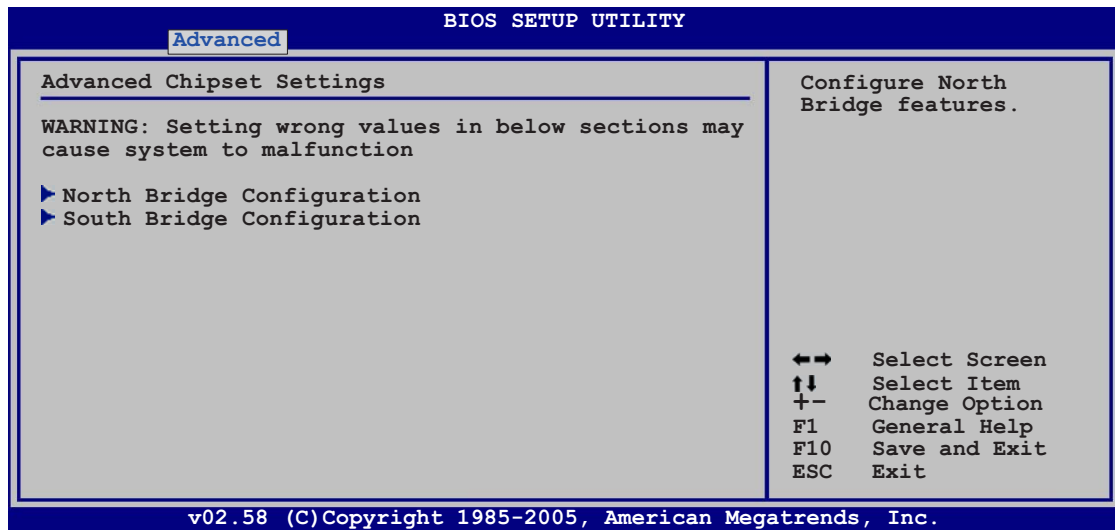

North Bridge Configuration

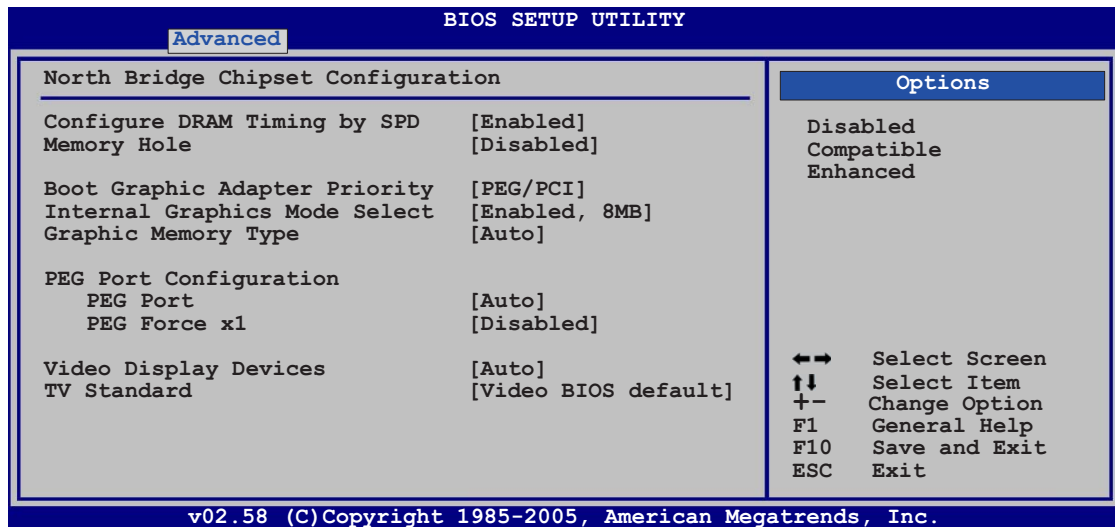

Configure DRAM Timing by SPD [Enabled]

When this item is enabled, the DRAM timing parameters are set according to the DRAM Serial Presence Detect (SPD). When disabled, you can manually set the DRAM timing parameters through the DRAM sub-items.

Configuration options: [Disabled] [Enabled]

The following sub-items appear when this item is disabled.

DRAM CAS# Latency [5 DRAM Clocks]

Controls the latency between the SDRAM read command and the time the data actually becomes available. Configuration options: [5 DRAM Clocks] [4 DRAM Clocks] [3 DRAM Clocks]

DRAM RAS# to CAS# Delay [6 DRAM Clocks]

Controls the latency between the DDR SDRAM active command and the read/write command. Configuration options: [2 DRAM Clocks] [3 DRAM Clocks] [4 DRAM Clocks] [5 DRAM Clocks] [6 DRAM Clocks]

DRAM RAS# Precharge [6 DRAM Clocks]

Controls the idle clocks after issuing a precharge command to the DDR SDRAM. Configuration options: [2 DRAM Clocks] [3 DRAM Clocks] [4 DRAM Clocks] [5 DRAM Clocks] [6 DRAM Clocks]

DRAM RAS# Activate to Precharge [15 DRAM Clocks]

Configuration options: [4 DRAM Clocks] ~ [15 DRAM Clocks]

Memory Hole [Disabled]

Sets or disables the software memory remapping around the memory hole.

Configuration options: [Disabled] [15MB - 16MB]

Boot Graphic Adapter Priority [PEG/PCI]

Allows selection of the graphics controller to use as primary boot device.

Configuration options: [IGD] [PCI/IGD] [PCI/PEG] [PEG/IGD] [PEG/PCI]

Internal Graphics Mode Select [Enabled, 8MB]

Allows you to disable the internal graphics device (IGD) or select the amount of system memory pre-allocated by the IGD.

Configuration options: [Disabled] [Enabled, 1MB] [Enabled, 8MB]

Graphic Memory Type [Auto]

Allows you to select the graphic memory type that the system will support.

Configuration options: [Auto] [DVMT] [FIX] [DVMT+FIX]

PEG Port [Auto]

Allows you to set to Auto or disable the PCI Express Graphics port.
Configuration options: [Auto] [Disabled]

PEG Force x1 [Disabled]

Allows you to set to enable or disable the PEG force x1.
Configuration options: [Enabled] [Disabled]

Video Display Devices [Auto]

Allows you to select the video display device to use.
Configuration options: [Auto] [CRT only] [TV only]

TV Standard [Video BIOS default]

Allows you to select the TV standard in your area.
Configuration options: [Video BIOS default] [NTSC] [PAL]

South Bridge Configuration

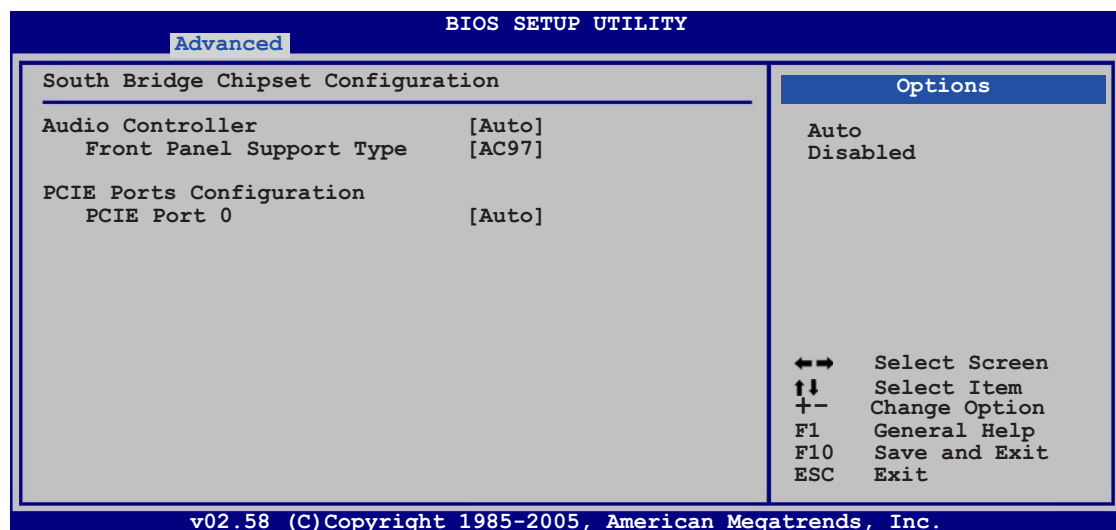

Audio Controller [Auto]

Allows you to disable the onboard audio controller, or lets the BIOS automatically configure. Configuration options: [Auto] [Disabled]

Front Panel Support Type [AC97]

Allows you to set the front panel audio connector (AAP) mode to legacy AC97 or High Definition Audio depending on the front panel audio module support. Configuration options: [AC97] [HD Audio]

PCIE Port 0 [Auto]

Configuration options: [Auto] [Enabled] [Disabled]

4.4.4 Onboard Devices Configuration

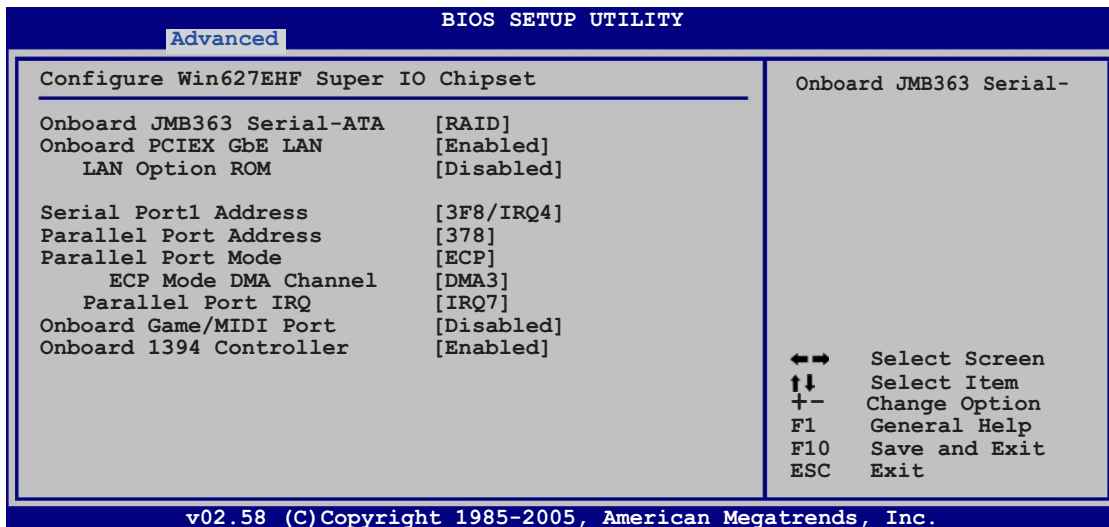

Onboard JMB363 Serial -ATA [RAID]

Allows you to disable or choose the function of the onboard JMB363 Serial ATA controller. Configuration options: [Disabled] [RAID] [IDE]

Onboard PCIEX GbE LAN [Enabled]

Allows you to enable or disable the onboard PCI Express Gigabit LAN controller. Configuration options: [Enabled] [Disabled]

LAN Option ROM [Disabled]

This item allows you to enable or disable the PCI Express Gigabit LAN boot ROM configuration. This item appears only when the **Onboard PCIEX GbE LAN** item is set to [Enabled]. Configuration options: [Disabled] [Enabled]

Serial Port1 Address [3F8/IRQ4]

Allows you to select the Serial Port1 base address. Configuration options: [Disabled] [3F8/IRQ4] [2F8/IRQ3] [3E8/IRQ4] [2E8/IRQ3]

Parallel Port Address [378]

Allows you to select the Parallel Port base addresses. Configuration options: [Disabled] [378] [278] [3BC]

Parallel Port Mode [ECP]

Allows you to select the Parallel Port mode.

Configuration options: [Normal] [Bi-Directional] [EPP] [ECP]

ECP Mode DMA Channel [DMA3]

Appears only when the Parallel Port Mode is set to [ECP]. This item allows you to set the Parallel Port ECP DMA channel.

Configuration options: [DMA0] [DMA1] [DMA3]

EPP Version [1.9]

Appears only when the Parallel Port Mode is set to [EPP]. Allows you to select the parallel port EPP version. Configuration options: [1.9] [1.7]

Parallel Port IRQ [IRQ7]

Allows you to select the parallel port IRQ.

Configuration options: [IRQ5] [IRQ7]

Onboard Game/MIDI Port [Disabled]

Allows you to select the Game/MIDI port address or to disable the port.

Configuration options: [Disabled] [200/300] [200/330] [208/300] [208/330]

Onboard 1394 Controller [Enabled]

Allows you to enable or disable the onboard IEEE 1394a controller.

Configuration options: [Enabled] [Disabled]

4.4.5 PCI PnP

The PCI PnP menu items allow you to change the advanced settings for PCI/PnP devices. The menu includes setting IRQ and DMA channel resources for either PCI/PnP or legacy ISA devices, and setting the memory size block for legacy ISA devices.



Take caution when changing the settings of the PCI PnP menu items. Incorrect field values can cause the system to malfunction.

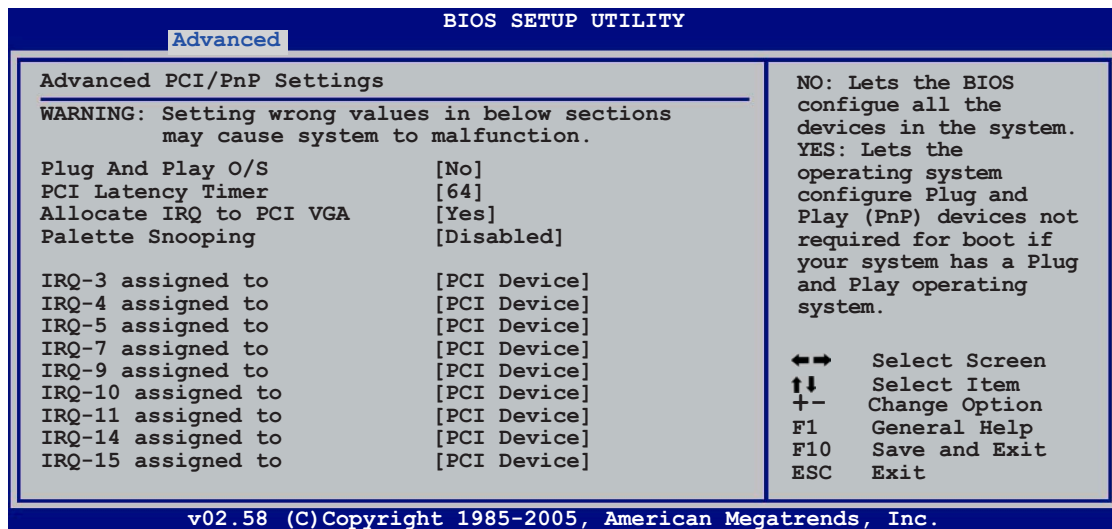

Plug And Play O/S [No]

When set to [No], BIOS configures all the devices in the system. When set to [Yes] and if you install a Plug and Play operating system, the operating system configures the Plug and Play devices not required for boot.

Configuration options: [No] [Yes]

PCI Latency Timer [64]

Allows you to select the value in units of PCI clocks for the PCI device latency timer register. Configuration options: [32] [64] [96] [128] [160] [192] [224] [248]

Allocate IRQ to PCI VGA [Yes]

When set to [Yes], BIOS assigns an IRQ to PCI VGA card if the card requests for an IRQ. When set to [No], BIOS does not assign an IRQ to the PCI VGA card even if requested. Configuration options: [Yes] [No]

Palette Snooping [Disabled]

When set to [Enabled], the palette snooping feature informs the PCI devices that an ISA graphics device is installed in the system so that the latter can function correctly. Configuration options: [Disabled] [Enabled]

IRQ-xx assigned to [PCI Device]

When set to [PCI Device], the specific IRQ is free for use of PCI/PnP devices. When set to [Reserved], the IRQ is reserved for legacy ISA devices. Configuration options: [PCI Device] [Reserved]

4.4.6 USB Configuration

The items in this menu allows you to change the USB-related features. Select an item then press <Enter> to display the configuration options.

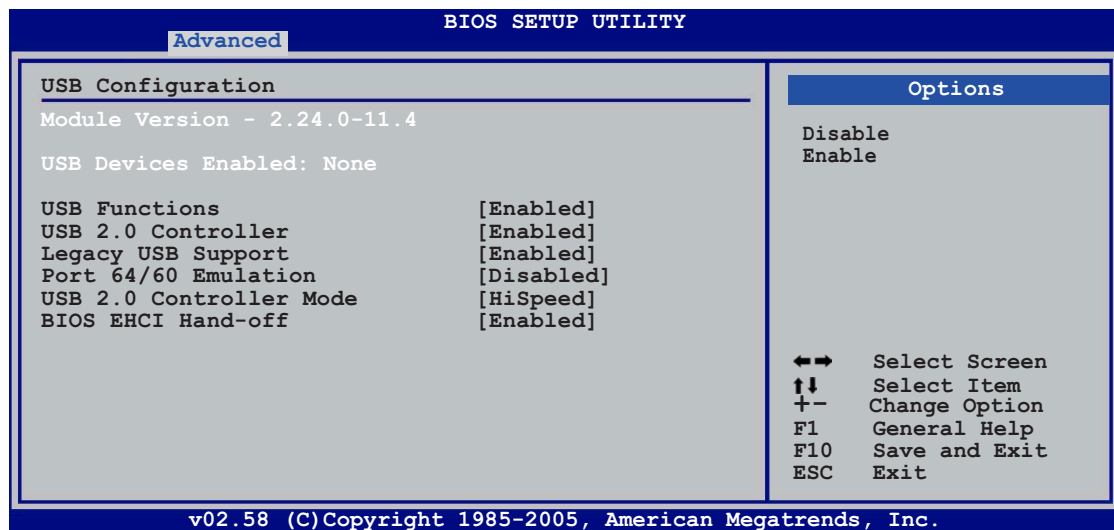

The **Module Version** and **USB Devices Enabled** items show the auto-detected values. If no USB device is detected, the item shows **None**.

USB Functions [Enabled]

Allows you to enable or disable the USB functions of the motherboard. Configuration options: [Disabled] [Enabled]

USB 2.0 Controller [Enabled]

Allows you to enable or disable the USB 2.0 controller. Configuration options: [Enabled] [Disabled]

Legacy USB Support [Enabled]

Allows you to enable or disable support for legacy USB devices. Setting to [Auto] allows the system to detect the presence of USB devices at startup. If detected, the USB controller legacy mode is enabled. If no USB device is detected, the legacy USB support is disabled. Configuration options: [Disabled] [Enabled] [Auto]

Port 64/60 Emulation [Disabled]

Allows you to enable or disable the I/O port 60h/64h emulation support. This item should be enabled for complete USB keyboard legacy support for non-USB aware operating systems. Configuration options: [Disabled] [Enabled]

USB 2.0 Controller Mode [HiSpeed]

Allows you to set the USB 2.0 controller mode to HiSpeed (480 Mbps) or FullSpeed (12 Mbps). Configuration options: [FullSpeed] [HiSpeed]

BIOS EHCI Hand-off [Enabled]

Allows you to enable support for operating systems without an EHCI hand-off feature. Configuration options: [Disabled] [Enabled]

4.5 Power menu

The Power menu items allow you to change the settings for the ACPI and Advanced Power Management (APM) features. Select an item then press <Enter> to display the configuration options.

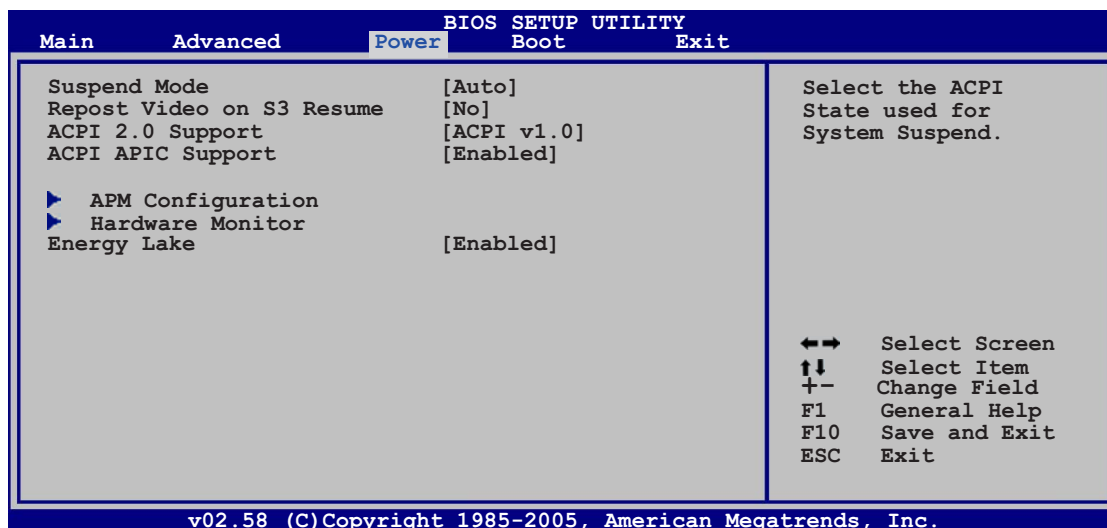

4.5.1 Suspend Mode [Auto]

Allows you to select the Advanced Configuration and Power Interface (ACPI) state to be used for system suspend. Setting this item to [Auto] allows the OS to select the ACPI state. Configuration options: [S1 (POS) Only] [S3 Only] [Auto]

4.5.2 Repost Video on S3 Resume [No]

Determines whether to invoke VGA BIOS POST on S3/STR resume. Configuration options: [No] [Yes]

4.5.3 ACPI 2.0 Support [ACPI v1.0]

Allows you to add more tables for Advanced Configuration and Power Interface (ACPI) 2.0 specifications. Configuration options: [ACPI v1.0] [ACPI v2.0] [ACPI v3.0]

4.5.4 ACPI APIC Support [Enabled]

Allows you to enable or disable the Advanced Configuration and Power Interface (ACPI) support in the Advanced Programmable Interrupt Controller (APIC). When set to Enabled, the ACPI APIC table pointer is included in the RSDT pointer list. Configuration options: [Disabled] [Enabled]

4.5.5 APM Configuration

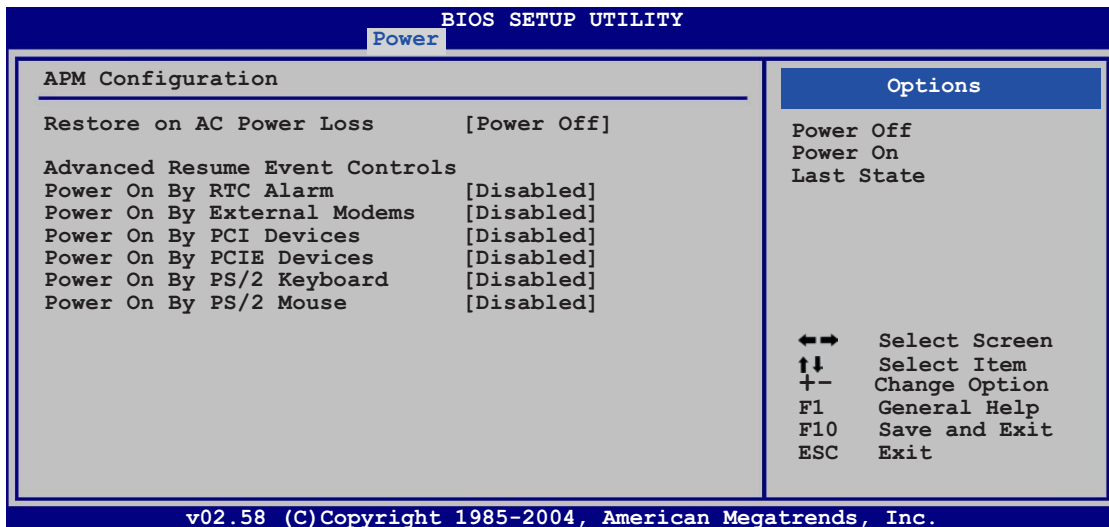

Restore on AC Power Loss [Power Off]

When set to Power Off, the system goes into off state after an AC power loss. When set to Power On, the system goes on after an AC power loss. When set to Last State, the system goes into either off or on state, whatever the system state was before the AC power loss.
Configuration options: [Power Off] [Power On] [Last State]

Power On By RTC Alarm [Disabled]

Allows you to enable or disable RTC to generate a wake event.
Configuration options: [Disabled] [Enabled]



The succeeding items appear when the **Power On By RTC Alarm** item is set to Enabled.

RTC Alarm Date (Days)

To set the alarm date, highlight this item and press the <+> or <-> key to make the selection.

RTC Alarm Time

To set the alarm time, use <Tab> or <Shift+Tab> to select a field. Use the <+> or <-> key to set the value. Press <Enter> to confirm the setting for each field.

Power On By External Modems [Disabled]

Allows either settings of [Enabled] or [Disabled] for powering up the computer when the external modem receives a call while the computer is in Soft-off mode. Configuration options: [Disabled] [Enabled]



The computer cannot receive or transmit data until the computer and applications are fully running. Thus, connection cannot be made on the first try. Turning an external modem off and then back on while the computer is off causes an initialization string that turns the system power on.

Power On By PCI Devices [Disabled]

When set to [Enabled], this parameter allows you to turn on the system through a PCI LAN or modem card. This feature requires an ATX power supply that provides at least 1A on the +5VSB lead.

Configuration options: [Disabled] [Enabled]

Power On By PCIE Devices [Disabled]

When set to [Enabled], this parameter allows you to turn on the system through a PCI Express card. Configuration options: [Disabled] [Enabled]

Power On By PS/2 Keyboard [Disabled]

Allows you to use specific keys on the keyboard to turn on the system. This feature requires an ATX power supply that provides at least 1A on the +5VSB lead. Configuration options: [Disabled] [Enabled]

Power On By PS/2 Mouse [Disabled]

When set to [Enabled], this parameter allows you to use the PS/2 mouse to turn on the system. This feature requires an ATX power supply that provides at least 1A on the +5VSB lead. Configuration options: [Disabled] [Enabled]

4.5.6 Hardware Monitor

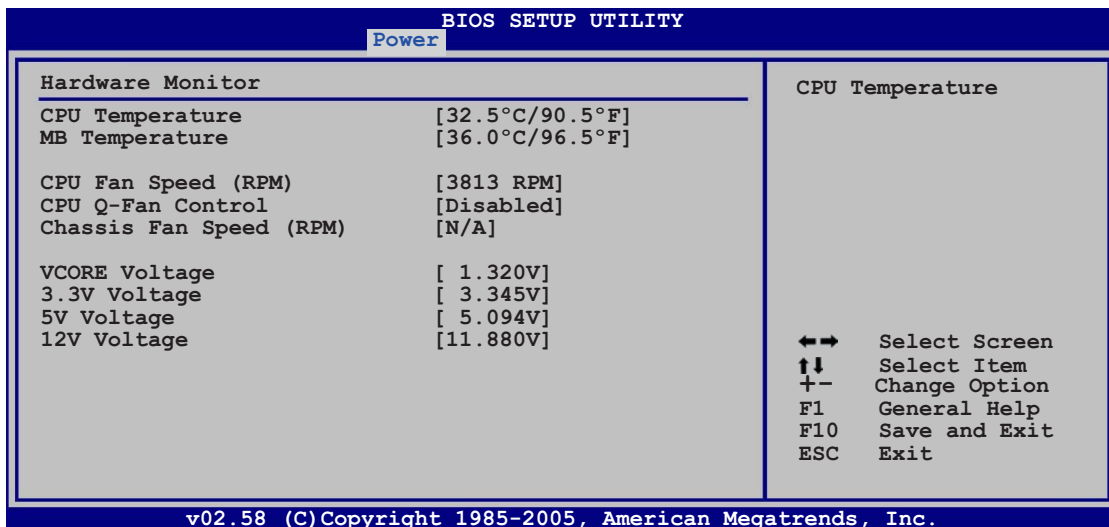

CPU Temperature [xxx°C/xxx°F]

MB Temperature [xxx°C/xxx°F]

The onboard hardware monitor automatically detects and displays the motherboard and CPU temperatures. Select [Ignored] if you do not wish to display the detected temperatures.

CPU Fan Speed (RPM) [xxxxRPM] or [Ignored]

The onboard hardware monitor automatically detects and displays the CPU fan speed in rotations per minute (RPM). If the fan is not connected to the motherboard, the field shows N/A. Select [Ignored] from the item options to disable CPU fan speed monitoring.

CPU Q-FAN Control [Disabled]

Allows you to enable or disable the ASUS Q-Fan feature that smartly adjusts the fan speeds for more efficient system operation.

Configuration options: [Disabled] [Enabled]



The following item appears when you enable the **CPU Q-FAN Control**.

CPU Fan Profile Mode [Optimal]

Allows you to select the CPU fan profile mode. Set to **Optimal** to enable the optimal Q-Fan settings for moderately quiet operation. Set to **Silent Mode** to minimize fan speed for very quiet operation. Set to **Performance Mode** to balance the fan speed and quiet operation.

Configuration options: [Optimal] [Silent Mode] [Performance Mode]

Chassis Fan Speed [xxxxRPM] or [Ignored]

The onboard hardware monitor automatically detects and displays the chassis fan speed in rotations per minute (RPM). If the fan is not connected to the chassis, the specific field shows N/A. Select [Ignored] from the item options to disable chassis fan speed monitoring.

VCORE Voltage, 3.3V Voltage, 5V Voltage, 12V Voltage

The onboard hardware monitor automatically detects the voltage output through the onboard voltage regulators.

4.5.7 Energy Lake Feature [Enabled]

Allows you to enable or disable the Energy Lake technology feature.
Configuration options: [Enabled] [Disabled]

4.6 Boot menu

The Boot menu items allow you to change the system boot options. Select an item then press <Enter> to display the sub-menu.

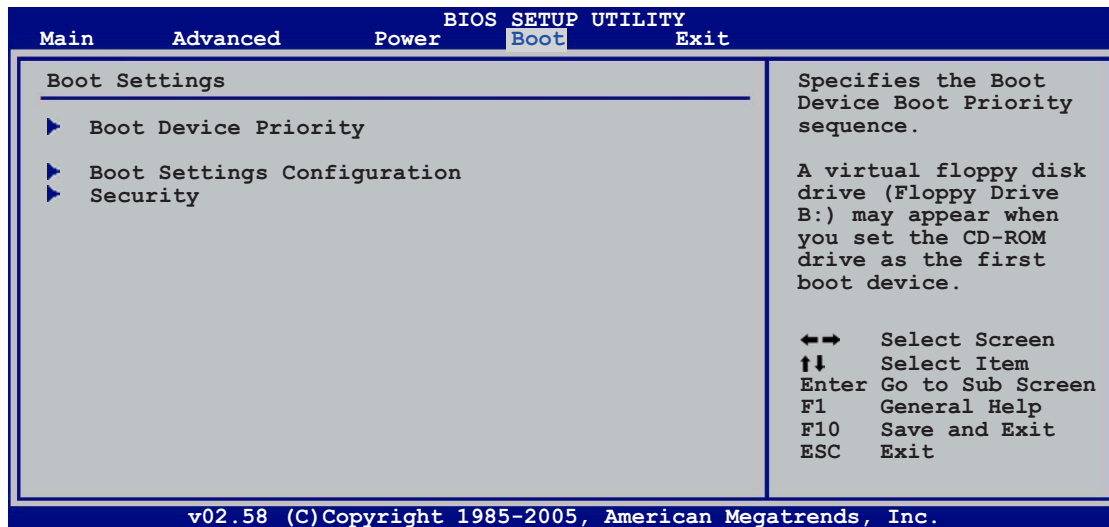

4.6.1 Boot Device Priority

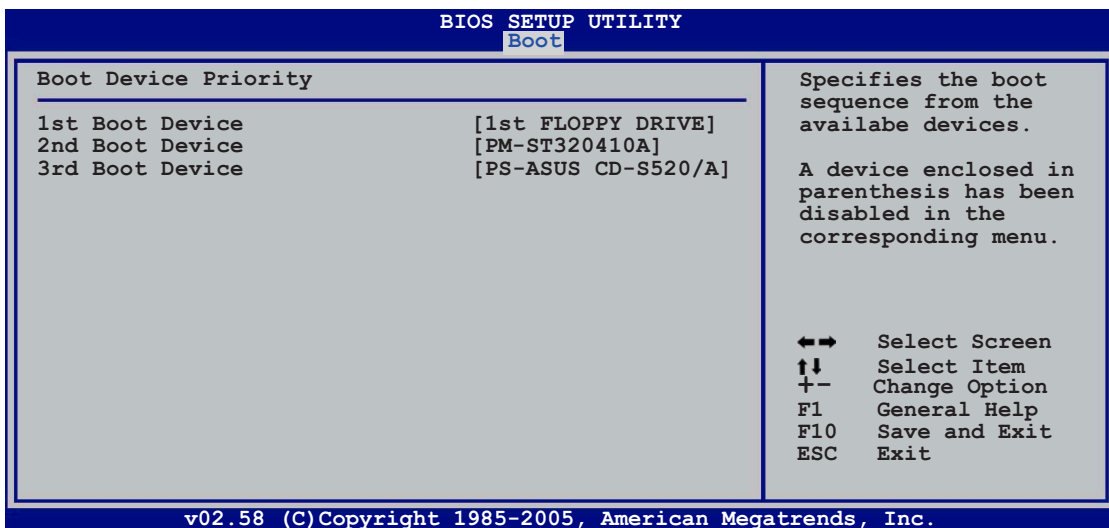

1st ~ xxth Boot Device [1st Floppy Drive]

These items specify the boot device priority sequence from the available devices. The number of device items that appears on the screen depends on the number of devices installed in the system.

Configuration options: [xxxxx Drive] [Disabled]

4.6.2 Boot Settings Configuration

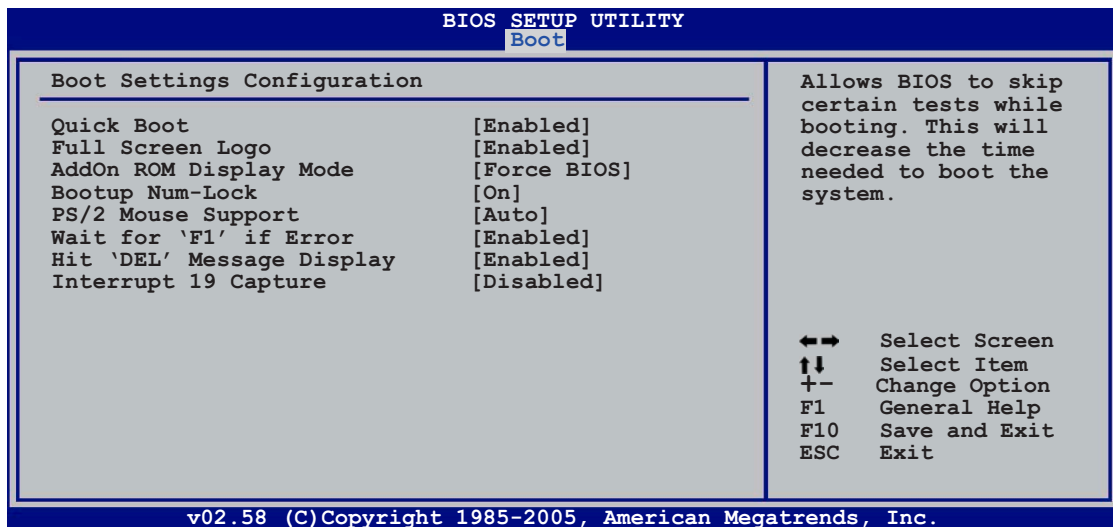

Quick Boot [Enabled]

Enabling this item allows the BIOS to skip some power on self tests (POST) while booting to decrease the time needed to boot the system. When set to [Disabled], BIOS performs all the POST items.

Configuration options: [Disabled] [Enabled]

Full Screen Logo [Enabled]

Allows you to enable or disable the full screen logo display feature.

Configuration options: [Disabled] [Enabled]



Set this item to [Enabled] to use the ASUS MyLogo™ feature.

Add On ROM Display Mode [Force BIOS]

Sets the display mode for option ROM.

Configuration options: [Force BIOS] [Keep Current]

Bootup Num-Lock [On]

Allows you to select the power-on state for the NumLock.

Configuration options: [Off] [On]

PS/2 Mouse Support [Auto]

Allows you to enable or disable support for PS/2 mouse.

Configuration options: [Disabled] [Enabled] [Auto]

Wait for 'F1' If Error [Enabled]

When set to Enabled, the system waits for the F1 key to be pressed when error occurs. Configuration options: [Disabled] [Enabled]

Hit 'DEL' Message Display [Enabled]

When set to Enabled, the system displays the message "Press DEL to run Setup" during POST. Configuration options: [Disabled] [Enabled]

Interrupt 19 Capture [Disabled]

When set to [Enabled], this function allows the option ROMs to trap Interrupt 19. Configuration options: [Disabled] [Enabled]

4.6.3 Security

The Security menu items allow you to change the system security settings. Select an item then press <Enter> to display the configuration options.

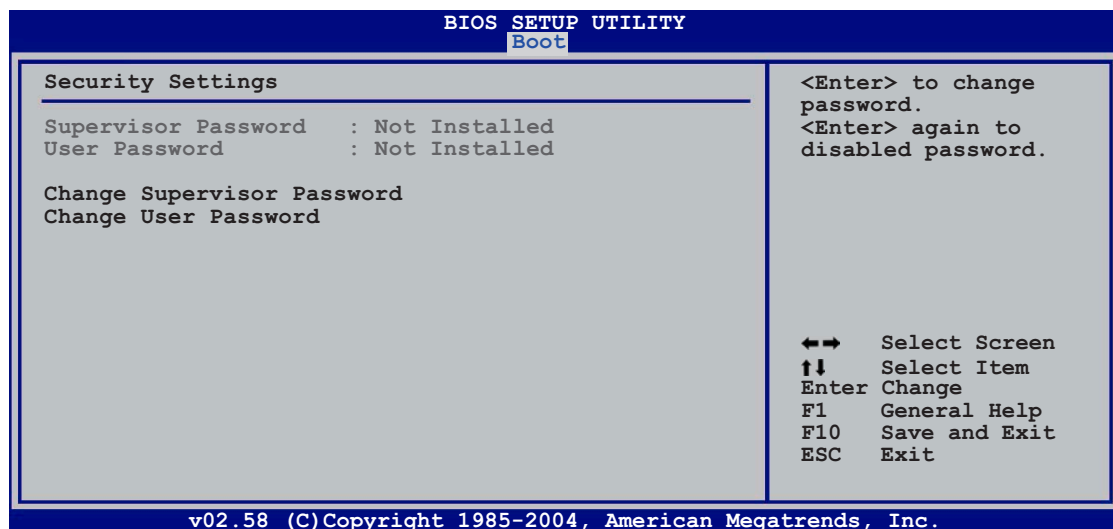

Change Supervisor Password

Select this item to set or change the supervisor password. The Supervisor Password item on top of the screen shows the default **Not Installed**. After you set a password, this item shows **Installed**.

To set a Supervisor Password:

1. Select the Change Supervisor Password item and press <Enter>.
2. From the password box, type a password composed of less than six letters and/or numbers, then press <Enter>.
3. Confirm the password when prompted.

The message "Password Installed" appears after you successfully set your password.

To change the supervisor password, follow the same steps as in setting a user password.

To clear the supervisor password, select the Change Supervisor Password then press <Enter>. The message “Password Uninstalled” appears.



If you forget your BIOS password, you can clear it by erasing the CMOS Real Time Clock (RTC) RAM. See section “2.6 Jumpers” for information on how to erase the RTC RAM.

After you have set a supervisor password, the other items appear to allow you to change other security settings.

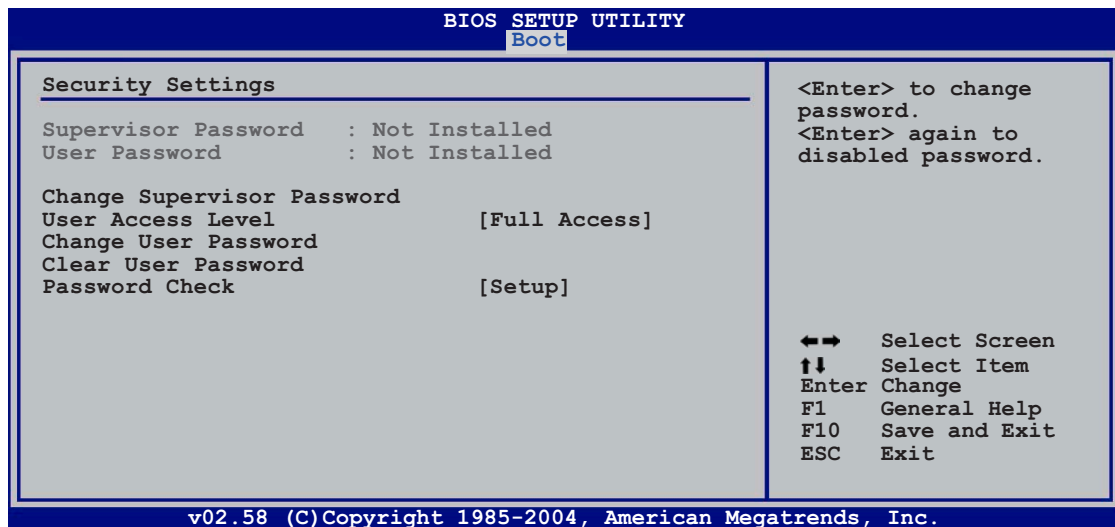

User Access Level (Full Access]

This item allows you to select the access restriction to the Setup items. Configuration options: [No Access] [View Only] [Limited] [Full Access]

No Access prevents user access to the Setup utility.

View Only allows access but does not allow change to any field.

Limited allows changes only to selected fields, such as Date and Time.

Full Access allows viewing and changing all the fields in the Setup utility.

Change User Password

Select this item to set or change the user password. The User Password item on top of the screen shows the default **Not Installed**. After you set a password, this item shows **Installed**.

Clear User Password

Select this item to clear the user password.

To set a User Password:

1. Select the Change User Password item and press <Enter>.
2. On the password box that appears, type a password composed of less than six letters and/or numbers, then press <Enter>.
3. Confirm the password when prompted.

The message “Password Installed” appears after you set your password successfully.

To change the user password, follow the same steps as in setting a user password.

Password Check [Setup]

When set to [Setup], BIOS checks for user password when accessing the Setup utility. When set to [Always], BIOS checks for user password both when accessing Setup and booting the system.

Configuration options: [Setup] [Always]

4.7 Exit menu

The Exit menu items allow you to load the optimal or failsafe default values for the BIOS items, and save or discard your changes to the BIOS items.

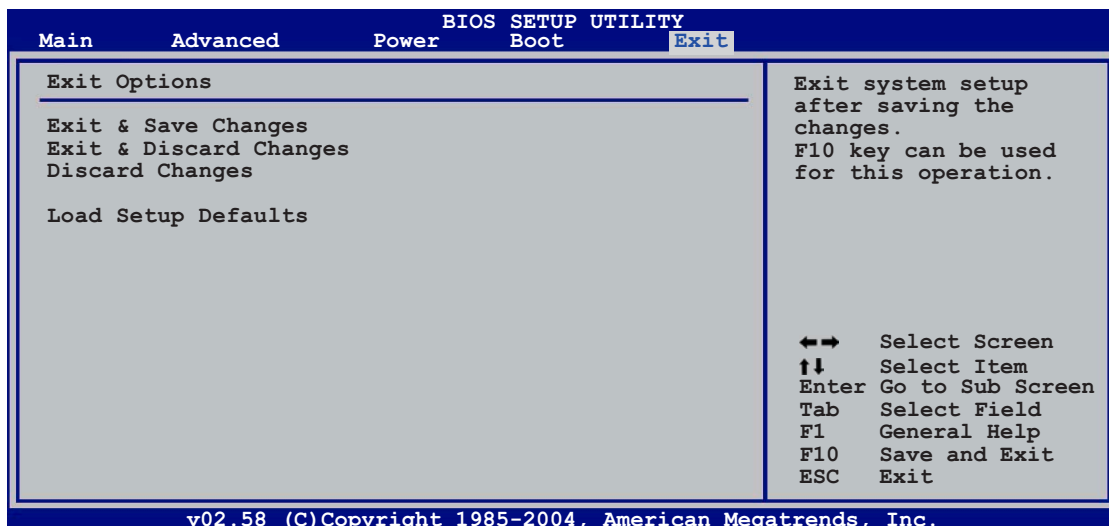

Pressing <Esc> does not immediately exit this menu. Select one of the options from this menu or <F10> from the legend bar to exit.

Exit & Save Changes

Once you are finished making your selections, choose this option from the Exit menu to ensure the values you selected are saved to the CMOS RAM. An onboard backup battery sustains the CMOS RAM so it stays on even when the PC is turned off. When you select this option, a confirmation window appears. Select **[Ok]** to save changes and exit.



If you attempt to exit the Setup program without saving your changes, the program prompts you with a message asking if you want to save your changes before exiting. Press <Enter> to save the changes while exiting.

Exit & Discard Changes

Select this option only if you do not want to save the changes that you made to the Setup program. If you made changes to fields other than System Date, System Time, and Password, the BIOS asks for a confirmation before exiting.

Discard Changes

This option allows you to discard the selections you made and restore the previously saved values. After selecting this option, a confirmation appears. Select **[Ok]** to discard any changes and load the previously saved values.

Load Setup Defaults

This option allows you to load the default values for each of the parameters on the Setup menus. When you select this option or if you press <F5>, a confirmation window appears. Select **[Ok]** to load default values. Select **Exit & Save Changes** or make other changes before saving the values to the non-volatile RAM.

This chapter describes the contents of the support CD that comes with the motherboard package.

5 Software support

5.1	Installing an operating system	5-1
5.2	Support CD information	5-1
5.3	Software information	5-9
5.4	RAID configurations	5-27
5.5	Creating a RAID driver disk	5-42

5.1 Installing an operating system

This motherboard supports Windows® 2000/2003 Server/XP/64-bit XP/MCE operating systems (OS). Always install the latest OS version and corresponding updates to maximize the features of your hardware.



- Motherboard settings and hardware options vary. Use the setup procedures presented in this chapter for reference only. Refer to your OS documentation for detailed information.
- Make sure that you install Windows® 2000 Service Pack 4 or the Windows® XP Service Pack 2 or later versions before installing the drivers for better compatibility and system stability.

5.2 Support CD information

The support CD that came with the motherboard package contains the drivers, software applications, and utilities that you can install to avail all motherboard features.



The contents of the support CD are subject to change at any time without notice. Visit the ASUS website(www.asus.com) for updates.

5.2.1 Running the support CD

Place the support CD to the optical drive. The CD automatically displays the **Drivers** menu if Autorun is enabled in your computer.

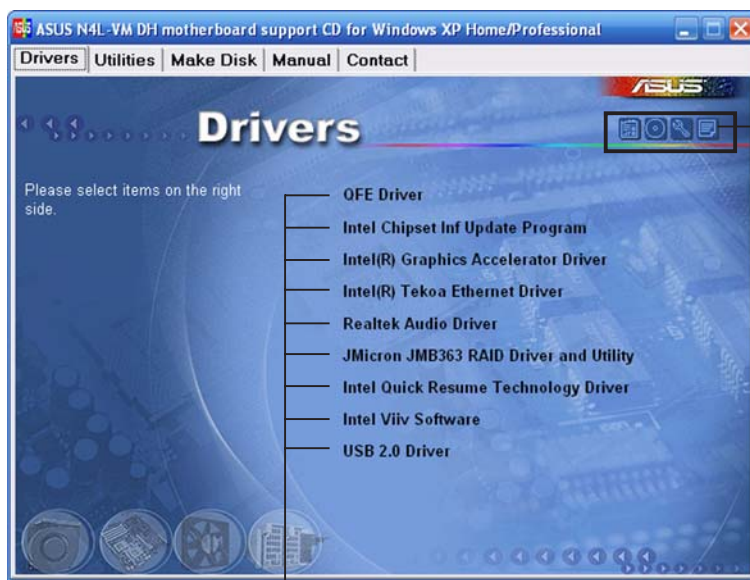

Click an icon to display support CD/motherboard information

Click an item to install



If **Autorun** is NOT enabled in your computer, browse the contents of the support CD to locate the file **ASSETUP.EXE** from the BIN folder. Double-click the **ASSETUP.EXE** to run the CD.

5.2.2 Drivers menu

The drivers menu shows the available device drivers if the system detects installed devices. Install the necessary drivers to activate the devices.

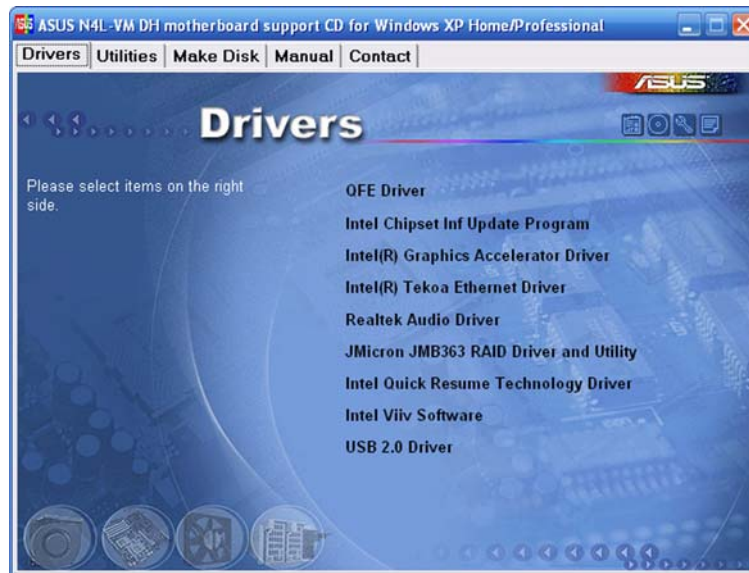

QFE Driver

Installs the Quick Fix Engineering (QFE) driver.

Intel Chipset Inf Update Program

Installs the Intel® Chipset INF Update Program. This driver enables Plug-n-Play INF support for the Intel® chipset components on the motherboard. When installed to the target system, this driver provides the method for configuring the chipset components.

You can install this utility using three different modes: interactive, silent, or unattended preload. Installing the driver in interactive mode require user input during installation. User input is not required when installing the driver in silent or unattended preload modes. Refer to the online help or readme file that came with the utility for details.

Intel(R) Graphics Accelerator Driver

Installs the Intel® Graphics Accelerator driver.

Intel(R) Tekoa Ethernet Driver

Installs the driver for the Intel® Tekoa PCI Express Gigabit LAN driver.

Realtek Audio Driver

Installs the Realtek® ALC882M audio driver and application.

JMicron JMB363 RAID Driver and Utility

Installs the JMicron® JMB363 RAID Driver and Utility.

Intel Quick Resume Technology Driver

Installs the Intel® Quick Resume Technology Driver (QRTD) for instant on/off (after initial boot, when activated) capability of an Intel® Viiv™ technology-based PC, allowing it to behave like a consumer electronic device.

Intel Viiv Software

Installs the Intel® Viiv™ utility that transforms your PC into an entertainment center, allowing you to enjoy and share digital multi-media content. With Intel® Viiv™ Technology-based computers, you can record, playback, organize, and edit digital media content easily. See page 5-xx for details.

USB 2.0 Driver

Installs the Universal Serial Bus 2.0 (USB 2.0) driver.

5.2.3 Utilities menu

The Utilities menu shows the applications and other software that the motherboard supports.

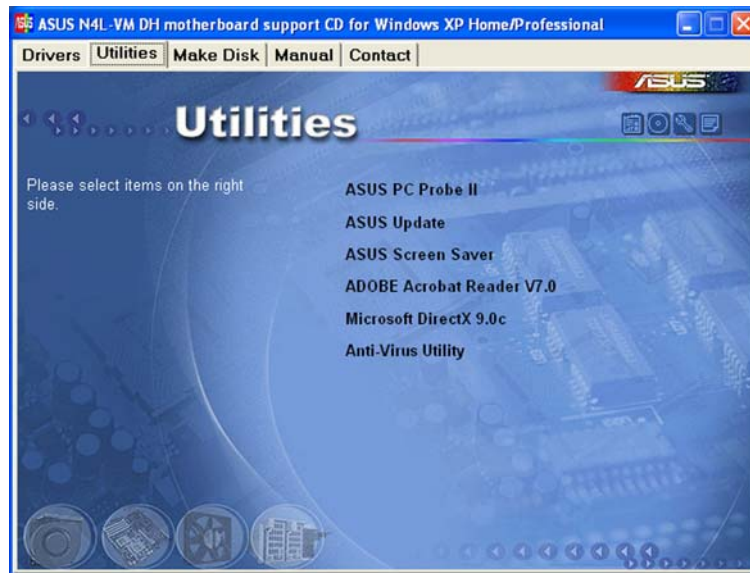

ASUS PC Probe II

This smart utility monitors the fan speed, CPU temperature, and system voltages, and alerts you of any detected problems. This utility helps you keep your computer in healthy operating condition.

ASUS Update

The ASUS Update utility allows you to update the motherboard BIOS in Windows® environment. This utility requires an Internet connection either through a network or an Internet Service Provider (ISP).

ASUS Screen Saver

Bring life to your computer screen by installing the ASUS screen saver.

ADOBE Acrobat Reader V7.0

Installs the Adobe® Acrobat® Reader that allows you to open, view, and print documents in Portable Document Format (PDF).

Microsoft DirectX 9.0c

Installs the Microsoft® DirectX® 9.0c driver. The Microsoft® DirectX® 9.0c is a multimedia technology that enhances computer graphics and sound. DirectX® improves the multimedia features of your computer so you can enjoy watching TV and movies, capturing videos, or playing games on your computer. Visit the Microsoft website (www.microsoft.com) for updates.

Anti-virus Utility

The anti-virus application scans, identifies, and removes computer viruses. View the online help for detailed information.

5.2.4 Make Disk menu

The Make Disk menu contains items to create the NVIDIA® nForce™ 4 or Silicon Image SATA/PATA RAID driver disk.



Intel ICH7 32-bit RAID Driver Disk

Allows you to create an Intel® ICH7 RAID driver disk for a 32-bit system.

JMicron JMB363 RAID Driver Disk

Allows you to create a JMicron JMB363 RAID driver disk.

5.2.5 Manuals menu

The Manuals menu contains a list of supplementary user manuals. Click an item to open the folder of the user manual.

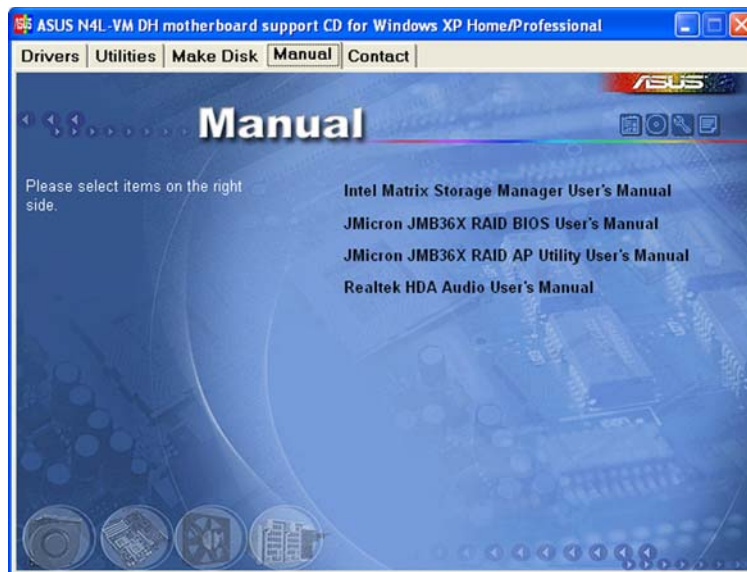

Most user manual files are in Portable Document Format (PDF). Install the Adobe® Acrobat® Reader from the **Utilities** menu before opening a user manual file.

5.2.6 ASUS Contact information

Click the **Contact** tab to display the ASUS contact information. You can also find this information on the inside front cover of this user guide.



5.2.7 Other information

The icons on the top right corner of the screen give additional information on the motherboard and the contents of the support CD. Click an icon to display the specified information.

Motherboard Info

Displays the general specifications of the motherboard.

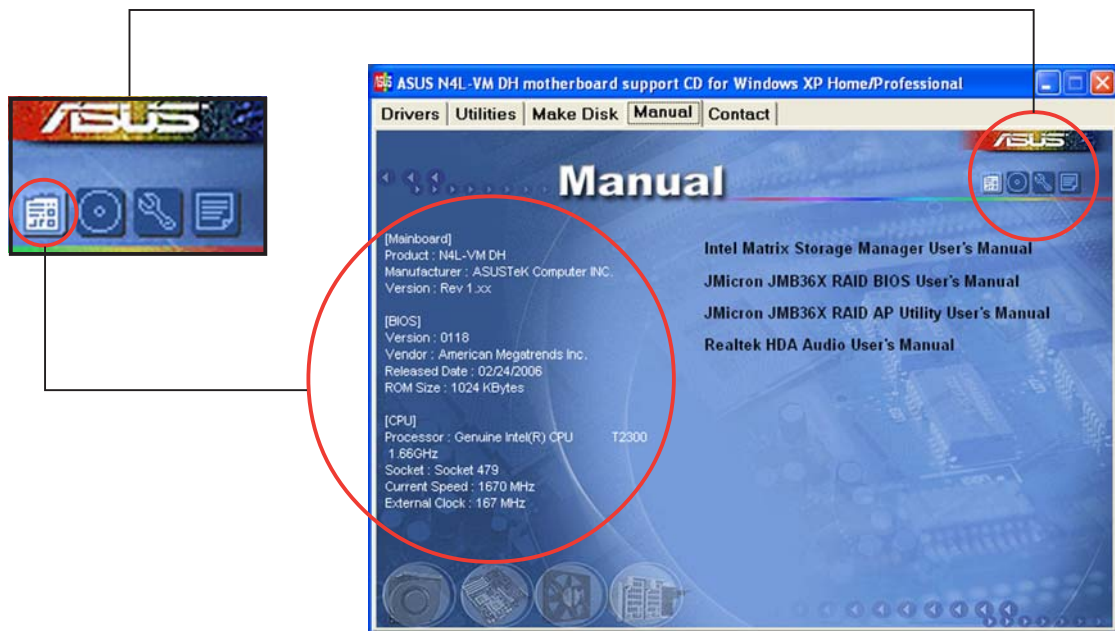

Browse this CD

Displays the support CD contents in graphical format.

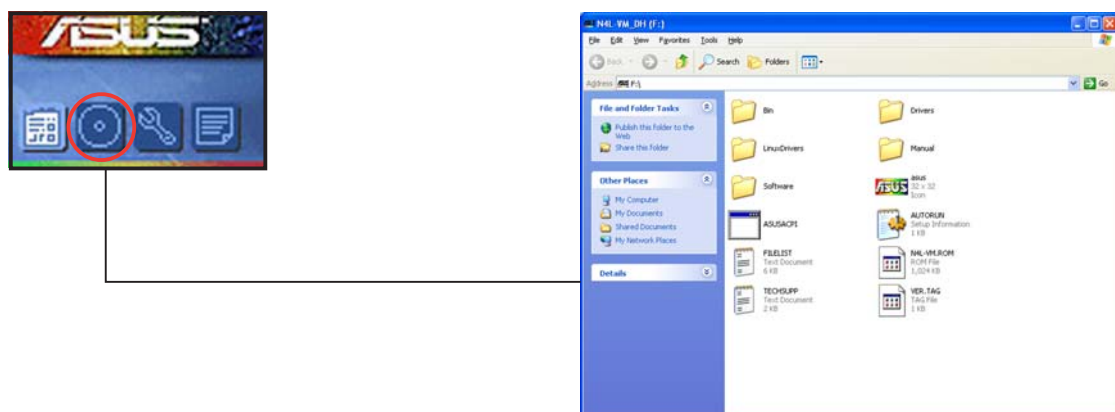

Technical support Form

Displays the ASUS Technical Support Request Form that you have to fill out when requesting technical support.

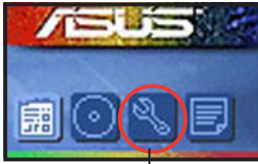

The screenshot shows a Notepad window titled "TCHSUPP - Notepad" containing the "ASUS™ TECHNICAL SUPPORT REQUEST FORM". The form is divided into several sections:

- ORIGINATOR DESCRIPTION:** Fields for COMPANY NAME, PHONE (AREA), EMAIL ADDRESS, CONTACT NAME, and FAX # (AREA).
- HARDWARE DESCRIPTION:** Fields for MOTHERBOARD, CPU BRAND, DRAM BRAND, CACHE BRAND, HARD DISK, CDROM BRAND, BACKUP BRAND, OTHER STORAGE, REVISION #, SPEED(MHz), SPEED(ns), MODEL NAME, and SIZE(MB).
- ADD-IN CARD DESCRIPTION (MODEL NAME/VENDOR):** Fields for (E)ISA SLOT 1-4, PCI-E SLOT 1-3, and PCI SLOT 1-5.
- SOFTWARE DESCRIPTION:** Fields for OPERATING SYSTEM, APPLICATION SOFTWARE, and DEVICE DRIVERS.
- PROBLEM DESCRIPTION (WHAT PROBLEMS AND UNDER WHAT SITUATIONS):** A large text area for describing the issue.

Filelist

Displays the contents of the support CD in text format.

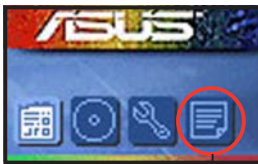

The screenshot shows a Notepad window titled "FILELIST - Notepad" containing a file list for the included support software for ML-M on motherboard. The list is organized by device drivers and includes the following items:

- Chipset:** QFE driver for Windows XP/XP MCE, Intel® chipset INF update Program v8.0.0.1003 for Windows 2000/XP/XP MCE/2003, Intel® Matrix Storage Manager driver v8.0.0.1009 for Windows 2000/XP/2003, Intel® quick resume technology driver v1.1.0.1030 for Windows XP MCE, Intel vity software v1.0.2.2013 for Windows XP MCE.
- Hdd/151:** Intel ICH7 32 bit RAID driver disk for Windows 2000/XP/XP MCE/2003.
- Lan:** Intel® teloa Ethernet driver v5.1.34.0 for Windows 2000/XP/XP MCE/2003, Realtek RTL8111B 10/100/1000M LAN driver v5.638.1116.2003 for Windows 2000/XP/XP MCE.
- VGA:** Intel® Graphics Accelerator driver v5.14.10.4436 for Windows 2000/XP/2003/MCE.
- RAID:** Intel® RAID driver and utility v5.1.2600.104 for Windows 2000/XP/2003, Intel® RAID driver disk for Windows 2000/XP/XP MCE/2003.
- Audio:** Realtek Audio driver v5.10.0.1211 for Windows 2000/XP/XP MCE/2003.
- USB:** USB 2.0 driver for Windows 2000/XP/XP MCE, USB 1.1 driver for Windows XP/XP MCE.
- Software:** Default Logo Bitmaps.
- AFUDOS:** (No description provided).

5.3 Software information

Most of the applications in the support CD have wizards that will conveniently guide you through the installation. View the online help or readme file that came with the software application for more information.

5.3.1 ASUS MyLogo™

The ASUS MyLogo™ utility lets you customize the boot logo. The boot logo is the image that appears on screen during the Power-On Self-Tests (POST). The ASUS MyLogo™ is automatically installed when you install the **ASUS Update** utility from the support CD. See section “5.2.3 Utilities menu” for details.



- Before using the ASUS MyLogo™, use the AFUDOS BIOS Flash utility to make a copy of your original BIOS file, or obtain the latest BIOS version from the ASUS website. See section “4.1.4 AFUDOS utility.”
- Make sure that the BIOS item **Full Screen Logo** is set to [Enabled] if you wish to use ASUS MyLogo. See section “4.6.2 Boot Settings Configuration.”
- You can create your own boot logo image in GIF, JPG, or BMP file formats.

To launch the ASUS MyLogo™:

1. Launch the ASUS Update utility. Refer to section “4.1.1 ASUS Update utility” for details.
2. Select **Options** from the drop down menu, then click **Next**.
3. Check the option **Launch MyLogo to replace system boot logo before flashing BIOS**, then click **Next**.
4. Select **Update BIOS from a file** from the drop down menu, then click **Next**.
5. When prompted, locate the new BIOS file, then click **Next**. The ASUS MyLogo window appears.
6. From the left window pane, select the folder that contains the image you intend to use as your boot logo.



7. When the logo images appear on the right window pane, select an image to enlarge by clicking on it.



8. Adjust the boot image to your desired size by selecting a value on the **Ratio** box.



9. When the screen returns to the ASUS Update utility, flash the original BIOS to load the new boot logo.
10. After flashing the BIOS, restart the computer to display the new boot logo during POST.

5.3.2 Audio configurations

The Realtek® ALC882M audio CODEC provides 8-channel audio capability to deliver the ultimate audio experience on your computer. The software provides Jack-Sensing function, S/PDIF Out support, and interrupt capability. The ALC882M also includes the Realtek® proprietary UAJ® (Universal Audio Jack) technology for all audio ports, eliminating cable connection errors and giving users plug and play convenience.

Follow the installation wizard to install the **Realtek® Audio Driver** from the support CD that came with the motherboard package.

If the Realtek audio software is correctly installed, you will find the Realtek HD Audio Manager icon on the taskbar.

From the taskbar, double-click on the **SoundEffect** icon to display the **Realtek HD Audio Manager**.



The following screens and menus are for reference only and may not exactly match what you see on your screen.

Realtek HD Audio Manager

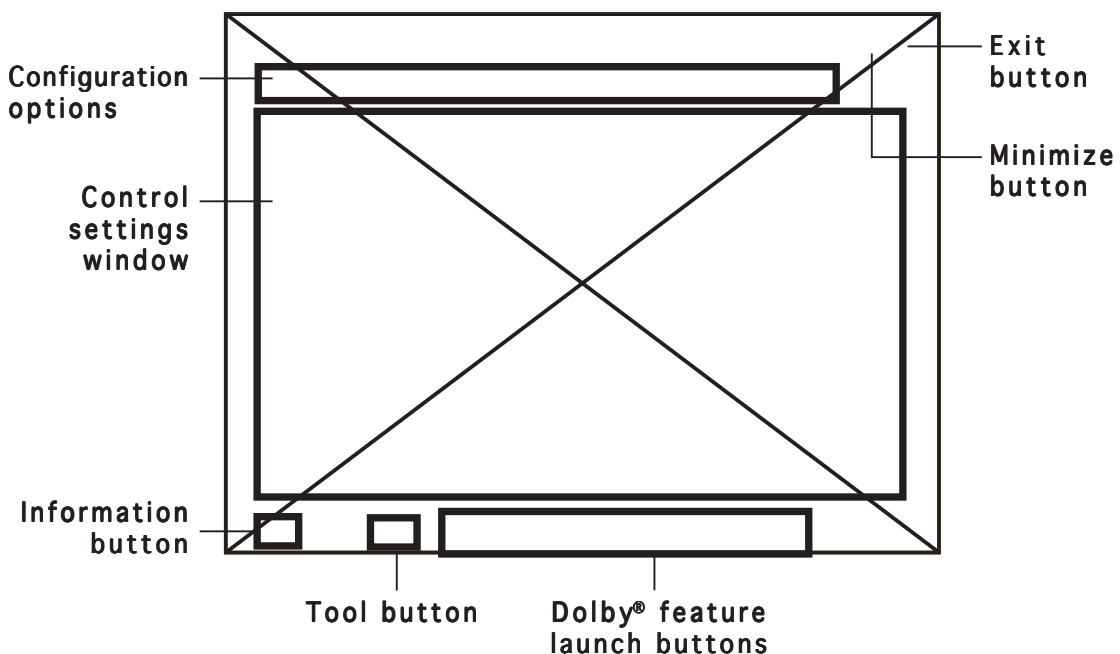

Information

Click the information button () to display information about the audio driver version, DirectX version, audio controller, audio codec, and language setting.



Tools

Click the tool button () to display tools for supported Dolby® applications.

Dolby® feature launch buttons

Click the button of the feature you want to launch.



Minimize

Click the minimize button () to minimize the window.

Exit

Click the exit button () to exit the Realtek HD Audio Manager.

Configuration options

Click any of the tabs in this area to configure your audio settings. Click the arrow button () to display more options.

Sound Effect

The Realtek® ALC882M Audio CODEC allows you to set your listening environment, adjust the equalizer, set the karaoke, or select pre-programmed equalizer settings for your listening pleasure.

To set the sound effect options:

1. From the Realtek HD Audio Manager, click the **Sound Effect** tab.
2. Click the shortcut buttons or the drop-down menus for options on changing the acoustic environment or adjust the equalizer to your desired settings.
3. Click  to effect the Sound Effect settings and exit.

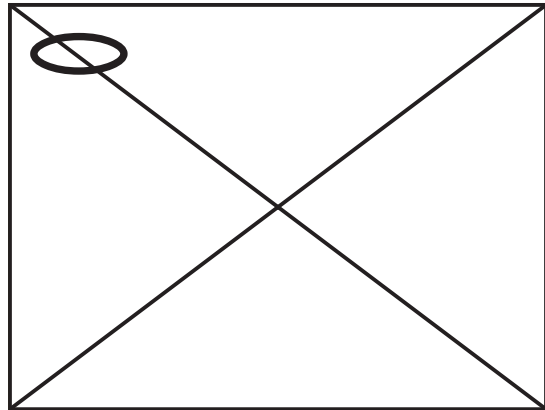

Mixer

The Mixer option allows you to configure audio output (playback) volume and audio input (record) volume.

To set the mixer options:

1. From the Realtek HD Audio Manager, click the **Mixer** tab.
2. Turn the volume buttons to adjust the Playback and/or Record volume.





The Mixer option activates voice input from all channels by default. Make sure to set those channels to mute () if you do not want voice input.

3. Make adjustments to Wave, SW Synth, Front, Rear, Subwoofer, CD volume, Mic volume, Line Volume, and Stereo mix by clicking the control tabs and dragging them up and down until you get the desired levels.
4. Click  to effect the Mixer settings and exit.

Bass Management setting

Click this tab to manage your bass settings.

To set the bass management options:

1. From the Realtek HD Audio Manager, click the **Bass Management setting** tab.
2. Click <M> to display the distance in meters, or <FT> to display the distance in feet.
3. Adjust the values to your desired settings by entering a numeric value in the boxes, or clicking the up/down arrow.
4. Click  to test your settings.
5. Click  to effect the Bass Management settings and exit.



Audio I/O

The Audio I/O option allows you to configure your input/output settings.

To set the Audio I/O options:

1. From the Realtek HD Audio Manager, click the **Audio I/O** tab.
2. Click the drop-down menu to select the channel configuration.
3. The control settings window displays the status of connected devices. Click  for analog and digital options.
4. Click <OK> to effect the Audio I/O settings and exit



Microphone

The Microphone option allows you to configure your input/output settings and to check if your audio devices are connected properly.

To set the Microphone options:

1. From the Realtek HD Audio Manager, click the **Microphone** tab.
2. Click the **Noise Suppression** option button to reduce the static background noise when recording.
3. Click the **Acoustic Echo Cancellation** option button to reduce the echo from the front speakers when recording.
4. Click  to effect the Microphone settings and exit.



3D Audio Demo

The 3D Audio Demo option gives you a demonstration of the 3D audio feature.

To start the 3D Audio Demo:

1. From the Realtek HD Audio Manager, click the **3D Audio Demo** tab.
2. Click the option buttons to change the sound, moving path, or environment settings.
3. Click  to test your settings.
4. Click  to effect the 3D Audio Demo settings and exit.



Designed for Dolby® Master Studio

Dolby® Master Studio combines advanced audio technologies to bring you the highest-quality in audio entertainment. Enjoy true home theatre experience with the following advanced sound technologies: Dolby Prologic IIx, Dolby Headphone, Dolby Virtual Speaker, and Dolby Digital Live.

Dolby® Headphone: Allows you to wear any pair of headphones and listen to music with the dramatic surround effects of a 5.1-channel audio configuration.

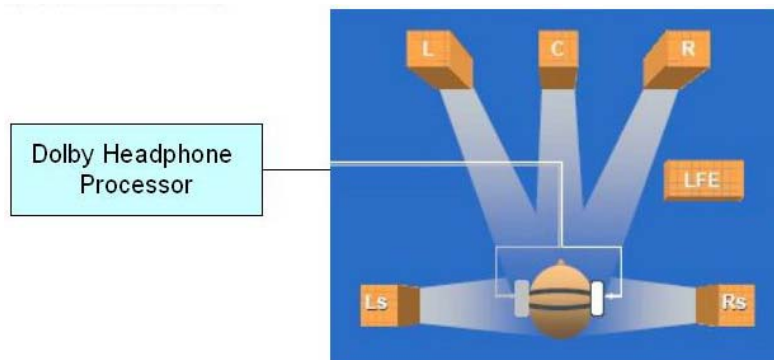

Dolby® Pro Logic IIx: expands any stereo audio or 5.1-channel audio for a 6.1 or 7.1-channel playback, creating a seamless, natural surround soundfield that immerses you in the entertainment experience.

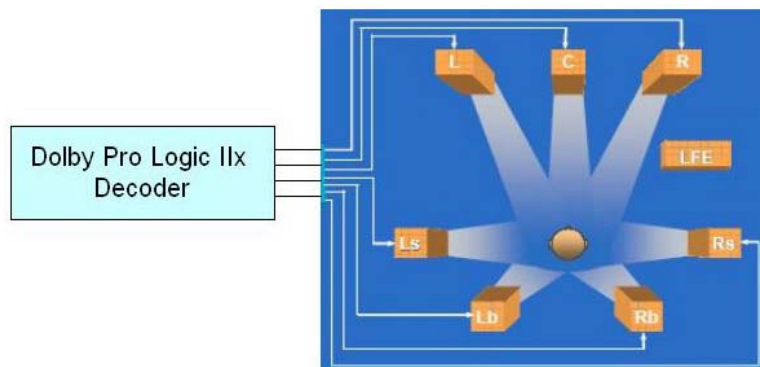

Dolby® Virtual Speaker: Simulates a highly realistic 5.1-speaker surround sound listening environment using only two speakers.

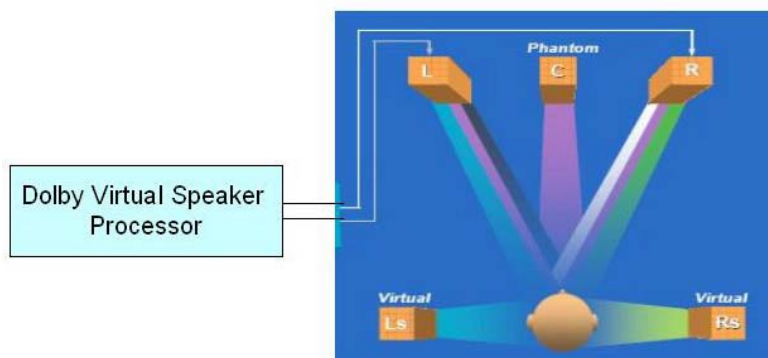

Using Dolby® Digital Live™

The Dolby® Digital Live™ technology encodes your computer's digital audio contents to real-time Dolby® Digital streams. Using the CODEC and the Sony/Philips Digital Interface (S/PDIF) ports on the motherboard, you can send the encoded Dolby® Digital streams to an AC-3 decoder for playback on a multi-channel speaker system.

Refer to the following illustrations when converting sounds to Dolby® Digital streams.

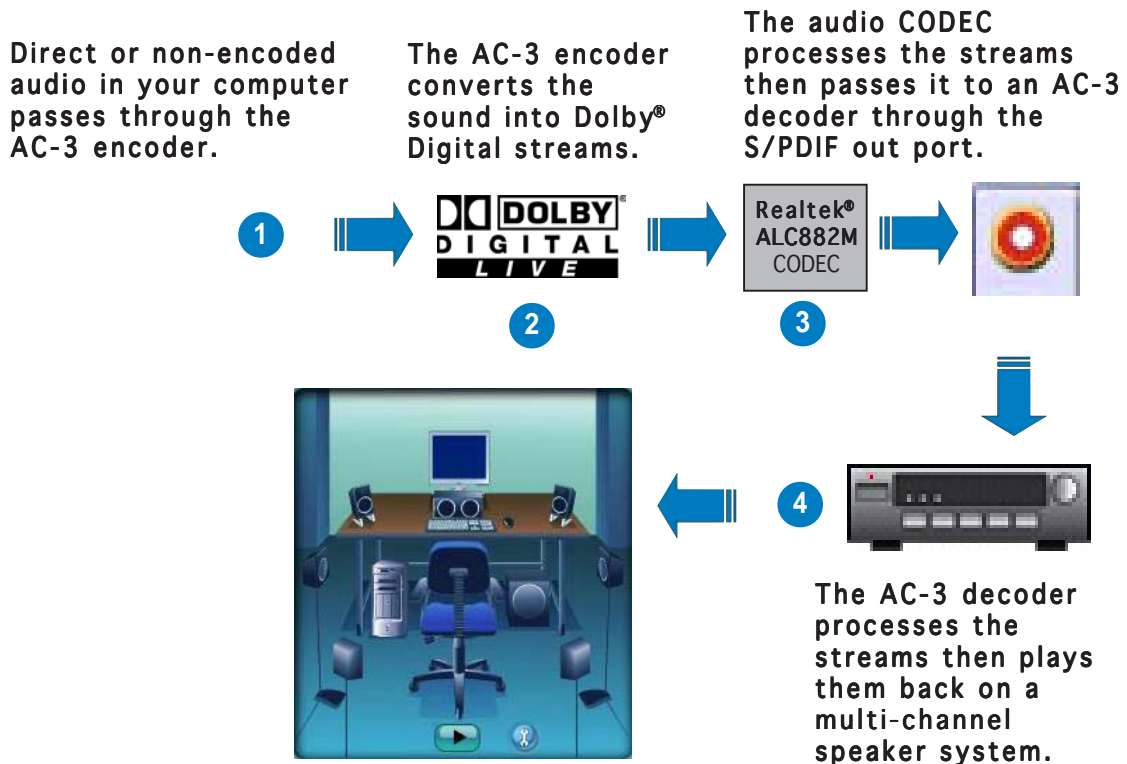

To enable the Dolby® Digital Live™:

1. Connect an AC-3 decoder to the coaxial/optical S/PDIF out port.
2. Connect the AC-3 decoder to the multi-channel speaker system.
3. Launch the **Realtek HD Audio Manager** by double clicking the **Realtek HD Audio Manager** icon on the Windows® taskbar.
4. Click the **Dolby Digital Live** button. You can now convert your computer's audio content to Dolby® Digital streams.



5.3.3 ASUS PC Probe II

PC Probe II is a utility that monitors the computer's vital components, and detects and alerts you of any problem with these components. PC Probe II senses fan rotations, CPU temperature, and system voltages, among others. Because PC Probe II is software-based, you can start monitoring your computer the moment you turn it on. With this utility, you are assured that your computer is always at a healthy operating condition.

Installing PC Probe II

To install PC Probe II on your computer:

1. Place the support CD to the optical drive. The **Drivers** installation tab appears if your computer has an enabled Autorun feature.



If Autorun is not enabled in your computer, browse the contents of the support CD to locate the setup.exe file from the ASUS PC Probe II folder. Double-click the setup.exe file to start installation.

2. Click the **Utilities** tab, then click **ASUS PC Probe II**.
3. Follow the screen instructions to complete installation.

Launching PC Probe II

You can launch the PC Probe II right after installation or anytime from the Windows® desktop.

To launch the PC Probe II from the Windows® desktop, click **Start > All Programs > ASUS > PC Probe II > PC Probe II v1.00.43**. The PC Probe II main window appears.

After launching the application, the PC Probe II icon appears in the Windows® taskbar. Click this icon to close or restore the application.









Using PC Probe II

Main window

The PC Probe II main window allows you to view the current status of your system and change the utility configuration. By default, the main window displays the **Preference** section. You can close or restore the **Preference** section by clicking on the triangle on the main window right handle.



Click to close the Preference panel

Button	Function
	Opens the Configuration window
	Opens the Report window
	Opens the Desktop Management Interface window
	Opens the Peripheral Component Interconnect window
	Opens the Windows Management Instrumentation window
	Opens the hard disk drive, memory, CPU usage window
	Shows/Hides the Preference section
	Minimizes the application
	Closes the application

Sensor alert

When a system sensor detects a problem, the main window right handle turns red, as the illustrations below show.



When displayed, the monitor panel for that sensor also turns red. Refer to the **Monitor panels** section for details.

Preferences

You can customize the application using the Preference section in the main window. Click the box before each preference to activate or deactivate.

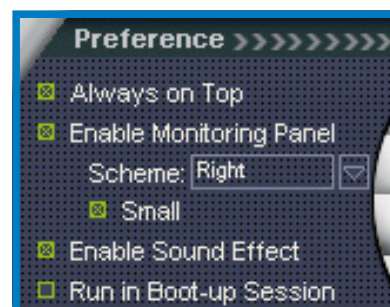

Hardware monitor panels

The hardware monitor panels display the current value of a system sensor such as fan rotation, CPU temperature, and voltages.

The hardware monitor panels come in two display modes: hexagonal (large) and rectangular (small). When you check the **Enable Monitoring Panel** option from the **Preference** section, the monitor panels appear on your computer's desktop.



Large display



Small display

Changing the monitor panels position

To change the position of the monitor panels in the desktop, click the arrow down button of the **Scheme** options, then select another position from the list box. Click **OK** when finished.

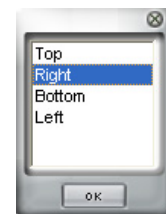

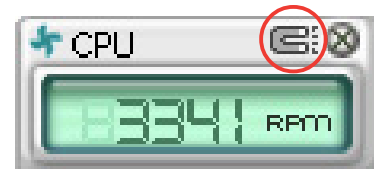

Moving the monitor panels

All monitor panels move together using a magnetic effect. If you want to detach a monitor panel from the group, click the horseshoe magnet icon. You can now move or reposition the panel independently.



Adjusting the sensor threshold value

You can adjust the sensor threshold value in the monitor panel by clicking the  or  buttons. You can also adjust the threshold values using the **Config** window.

You cannot adjust the sensor threshold values in a small monitoring panel.

Click to increase value

Click to decrease value



Monitoring sensor alert

The monitor panel turns red when a component value exceeds or is lower than the threshold value. Refer to the illustrations below.



Large display



Small display

WMI browser

Click **WMI** to display the WMI (Windows Management Instrumentation) browser. This browser displays various Windows® management information. Click an item from the left panel to display on the right panel. Click the plus sign (+) before **WMI Information** to display the available information.

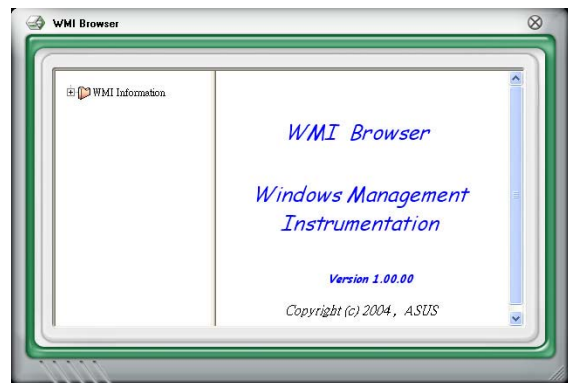

You can enlarge or reduce the browser size by dragging the bottom right corner of the browser.

DMI browser

Click **DMI** to display the DMI (Desktop Management Interface) browser. This browser displays various desktop and system information. Click the plus sign (+) before **DMI Information** to display the available information.



PCI browser

Click **PCI** to display the PCI (Peripheral Component Interconnect) browser. This browser provides information on the PCI devices installed on your system. Click the plus sign (+) before the **PCI Information** item to display available information.

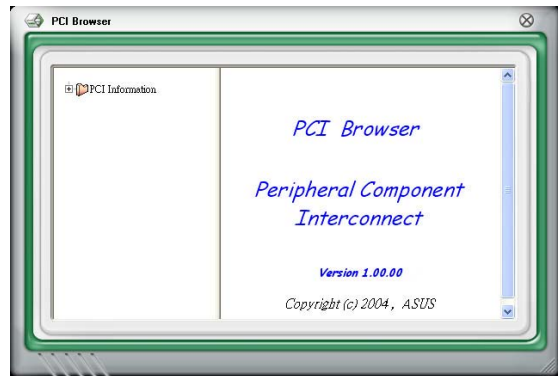

Usage

The **Usage** browser displays real-time information on the CPU, hard disk drive space, and memory usage. Click **USAGE** to display the Usage browser.

CPU usage

The **CPU** tab displays real-time CPU usage in line graph representation. If the CPU has an enabled Hyper-Threading, two separate line graphs display the operation of the two logical processors.

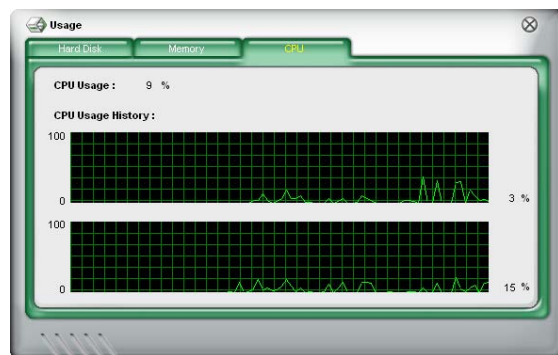

Hard disk drive space usage

The **Hard Disk** tab displays the used and available hard disk drive space. The left panel of the tab lists all logical drives. Click a hard disk drive to display the information on the right panel. The pie chart at the bottom of the window represents the used (blue) and the available HDD space.

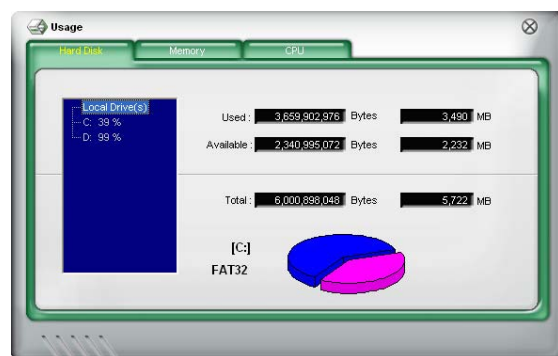

Memory usage

The Memory tab shows both used and available physical memory. The pie chart at the bottom of the window represents the used (blue) and the available physical memory.

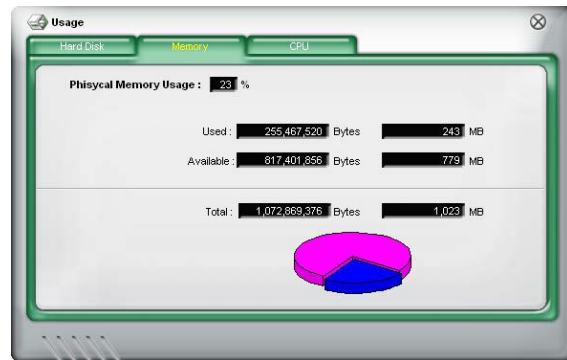

Configuring PC Probe II

Click  to view and adjust the sensor threshold values.

The **Config** window has two tabs: **Sensor/Threshold** and **Preference**. The **Sensor/Threshold** tab enables you to activate the sensors or to adjust the sensor threshold values. The **Preference** tab allows you to customize sensor alerts, or change the temperature scale.

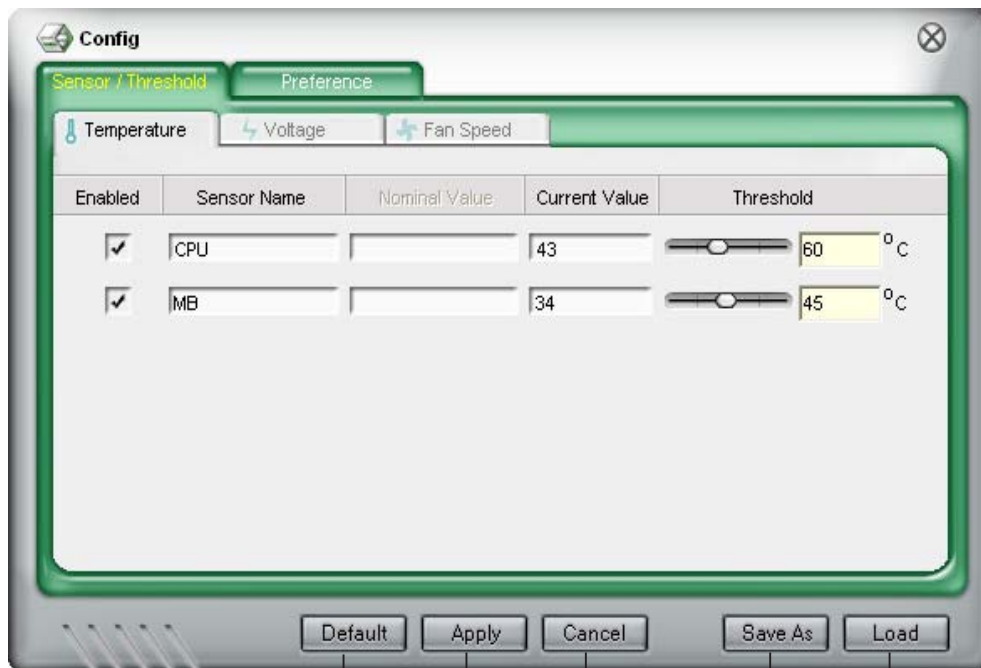

Loads the default threshold values for each sensor

Applies your changes

Cancel
Cancels or ignores your changes

Loads your saved configuration

Saves your configuration

5.3.4 Intel® Viiv™

Intel® Viiv™ Technology transforms your PC into an entertainment center, allowing you to enjoy and share digital multi-media content like never before. With Intel® Viiv™ Technology-based computers, you can record, playback, organize, and edit digital media content easily. Enjoy the entertainment experience even more with sharp graphics, flawless video playback, and support for up to 7.1 channel surround sound.



Refer to this section for instructions on how to install the Intel® Viiv™ software.



- The Intel® Viiv™ software will run only on motherboards with the required chipset, such as the N4L-VM DH. Visit the Intel® website for detailed information about Viiv™.
- Make sure you have installed Microsoft® Windows® Media Center Edition SP2 on your system. The Intel® Viiv™ software will run only on this operating system.
- Visit the Intel® website at www.intel.com for more details about Intel® Viiv™.

To install Intel® Viiv™ :

1. Place the support CD in the optical drive.
2. When the drivers menu appears, click **Intel Viiv Software**.

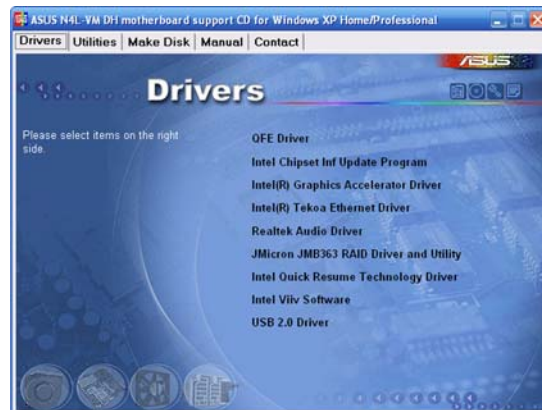

3. A warning message appears. Exit other programs that are running, then click **OK**.

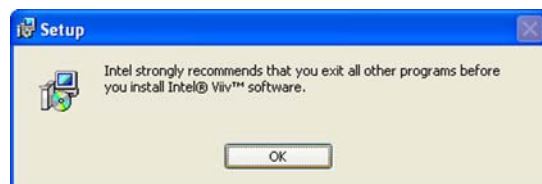

4. The Setup window appears. Click **Next**.

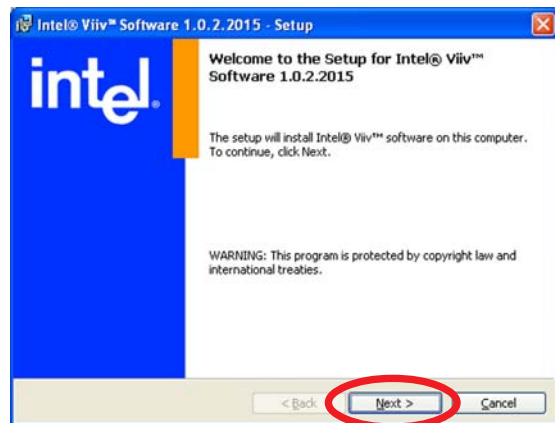

5. Read the License Agreement, then click the appropriate button to accept the terms. Click **Next**.

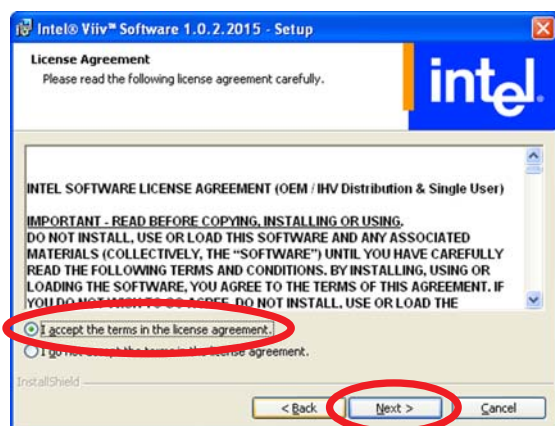

6. The next screen displays the default destination folder. Click **Next** to install to this folder, or click **Change** to install to a different folder.



7. Click **Install** to begin installation; otherwise, click **Back** change the installation settings, or click **Cancel** to exit setup without installing.

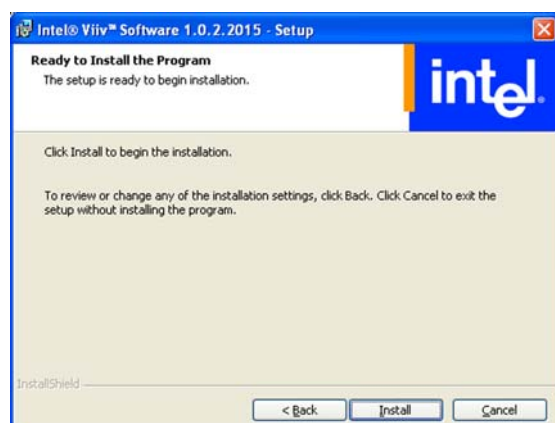

- Installation begins. A status bar shows the progress of the installation.



- When setup is complete, click **Finish**.

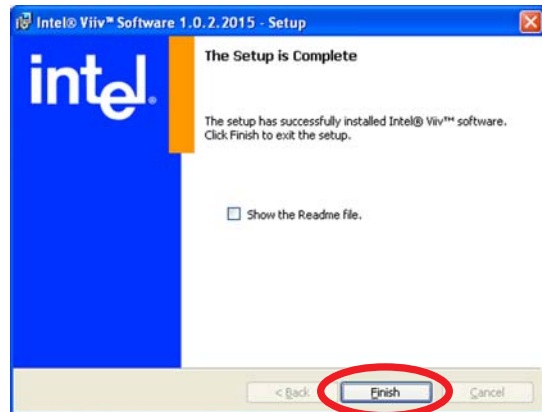

5.4 RAID configurations

The Intel® ICH7-M (DH) Southbridge features an onboard RAID controller that allow you to configure Serial ATA hard disk drives as RAID sets. The motherboard supports the following RAID configurations.

RAID 0 (*Data striping*) optimizes two identical hard disk drives to read and write data in parallel, interleaved stacks. Two hard disks perform the same work as a single drive but at a sustained data transfer rate, double that of a single disk alone, thus improving data access and storage. Use of two new identical hard disk drives is required for this setup.

RAID 1 (*Data mirroring*) copies and maintains an identical image of data from one drive to a second drive. If one drive fails, the disk array management software directs all applications to the surviving drive as it contains a complete copy of the data in the other drive. This RAID configuration provides data protection and increases fault tolerance to the entire system. Use two new drives or use an existing drive and a new drive for this setup. The new drive must be of the same size or larger than the existing drive.

RAID 0+1 is *data striping* and *data mirroring* combined without parity (redundancy data) having to be calculated and written. With the RAID 0+1 configuration you get all the benefits of both RAID 0 and RAID 1 configurations. Use four new hard disk drives or use an existing drive and three new drives for this setup.



If you want to boot the system from a hard disk drive included in a RAID set, copy first the RAID driver from the support CD to a floppy disk before you install an operating system to a selected hard disk drive. Refer to section “5.6 Creating a RAID driver disk” for details.

5.4.1 Installing hard disks

The motherboard supports Ultra DMA 100/66 and Serial ATA hard disk drives. For optimal performance, install identical drives of the same model and capacity when creating a disk array.

Installing Serial ATA (SATA) hard disks

To install the SATA hard disks for a RAID configuration:

1. Install the SATA hard disks into the drive bays.
2. Connect the SATA signal cables.
3. Connect a SATA power cable to the power connector on each drive.



Refer to the RAID controllers user manual in the motherboard support CD for detailed information on RAID configurations. See section “5.2.4 Manuals menu.”

5.4.2 Intel® RAID configurations

This motherboard supports RAID 0 and RAID 1 configurations for Serial ATA hard disks drives through the Intel® ICH7-M (DH) Southbridge chip.

Setting the RAID item in BIOS

You must set the RAID item in the BIOS Setup before you can create a RAID set(s). To do this:

1. Enter the BIOS Setup during POST.
2. Go to the **Main Menu**, select **IDE Configuration**, then press <Enter>.
3. Select the item **ATA/IDE Configuration**, then press <Enter> to display the configuration options.
4. From the configuration options, choose [Enhanced], then press <Enter> to set.
5. Select the item **Configure SATA As**, then press <Enter> to display the configuration options.
6. From the configuration options, choose [RAID], then press <Enter> to set.
7. Save your changes, then exit the BIOS Setup.



Refer to the Chapter 4 of the motherboard user guide for details on entering and navigating through the BIOS Setup.

Intel® Matrix Storage Manager Option ROM Utility

The Intel® Matrix Storage Manager Option ROM utility allows you to create RAID 0 and RAID 1 set(s) from Serial ATA hard disk drives that are connected to the Serial ATA connectors supported by the Southbridge.

To enter the Intel® Matrix Storage Manager Option ROM utility:

1. Install all the Serial ATA hard disk drives.
2. Turn on the system.
3. During POST, press <Ctrl+I> to display the utility main menu.

```
Intel(R) Matrix Storage Manager option ROM v5.7.0.1005 ICH7MR
Copyright(C) 2003-05 Intel Corporation. All Rights Reserved.

[ MAIN MENU ]
1. Create RAID Volume
2. Delete RAID Volume
3. Reset Disks to Non-RAID
4. Exit

[ DISK/VOLUME INFORMATION ]

RAID Volumes:
None defined.

Physical Disks:
Port Drive Model          Serial #          Size          Type/Status(Vol ID)
0  XXXXXXXXXXXX          XXXXXXXX          XX.XXGB      Non-RAID Disk
1  XXXXXXXXXXXX          XXXXXXXX          XX.XXGB      Non-RAID Disk
2  XXXXXXXXXXXX          XXXXXXXX          XX.XXGB      Non-RAID Disk
3  XXXXXXXXXXXX          XXXXXXXX          XX.XXGB      Non-RAID Disk

[↑↓]-Select          [ESC]-Exit          [ENTER]-Select Menu
```

The navigation keys at the bottom of the screen allow you to move through the menus and select the menu options.



The RAID BIOS setup screens shown in this section are for reference only and may not exactly match the items on your screen.

Creating a RAID 0 set (striped)

To create a RAID 0 set:

1. From the utility main menu, select **1. Create RAID Volume**, then press <Enter>. This screen appears.

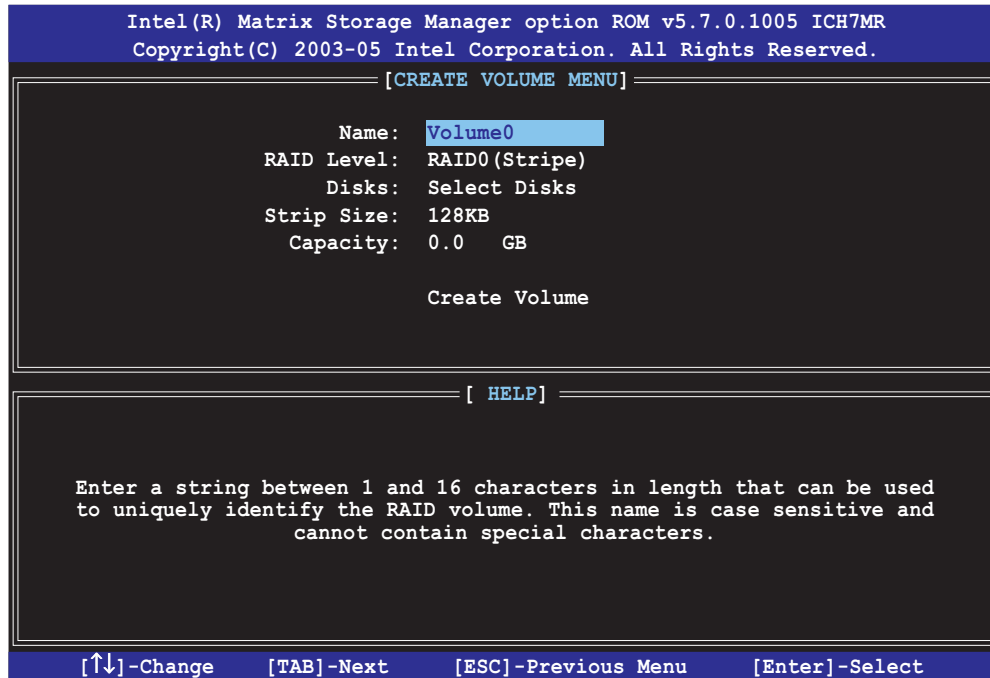

2. Enter a name for the RAID 0 set, then press <Enter>.
3. When the **RAID Level** item is highlighted, press the up/down arrow key to select **RAID 0(Stripe)**, then press <Enter>.
4. Use the up/down arrow key to select the stripe size for the RAID 0 array, then press <Enter>. The available stripe size values range from 4 KB to 128 KB. The default stripe size is 128 KB.



TIP: We recommend a lower stripe size for server systems, and a higher stripe size for multimedia computer systems used mainly for audio and video editing.

5. When the **Capacity** item is highlighted, key in the RAID volume capacity that you want, then press <Enter>. The default value indicates the maximum allowed capacity.
6. Press <Enter> when the **Create Volume** item is highlighted. The following warning message appears.

```

WARNING: ALL DATA ON SELECTED DISKS WILL BE LOST.

Are you sure you want to create this volume? (Y/N):

```

7. Press <Y> to create the RAID volume and return to the main menu, or <N> to go back to the Create Volume menu.
8. When the RAID volume is created, the main menu displays relevant information about the volume.

```

Intel(R) Matrix Storage Manager option ROM v5.7.0.1005 ICH7MR
Copyright(C) 2003-05 Intel Corporation. All Rights Reserved.

[ MAIN MENU ]
1. Create RAID Volume
2. Delete RAID Volume
3. Reset Disks to Non-RAID
4. Exit

[ DISK/VOLUME INFORMATION ]

RAID Volumes:
ID      Name      Level      Strip      Size      Status      Bootable
0       Volumename RAID0(Stripe) XXXKB     XXX.XXGB   Normal     Yes

Physical Disks:
Port Drive Model      Serial #      Size      Type/Status(Vol ID)
0       XXXXXXXXXXXX     XXXXXXXX     XX.XXGB   Member Disk(0)
2       XXXXXXXXXXXX     XXXXXXXX     XX.XXGB   Member Disk(0)

[↑↓]-Select      [ESC]-Exit      [ENTER]-Select Menu

```

Creating a RAID 1 set (mirrored)

To create a RAID 1 set:

1. From the utility main menu, select **1. Create RAID Volume**, then press <Enter>. This screen appears.

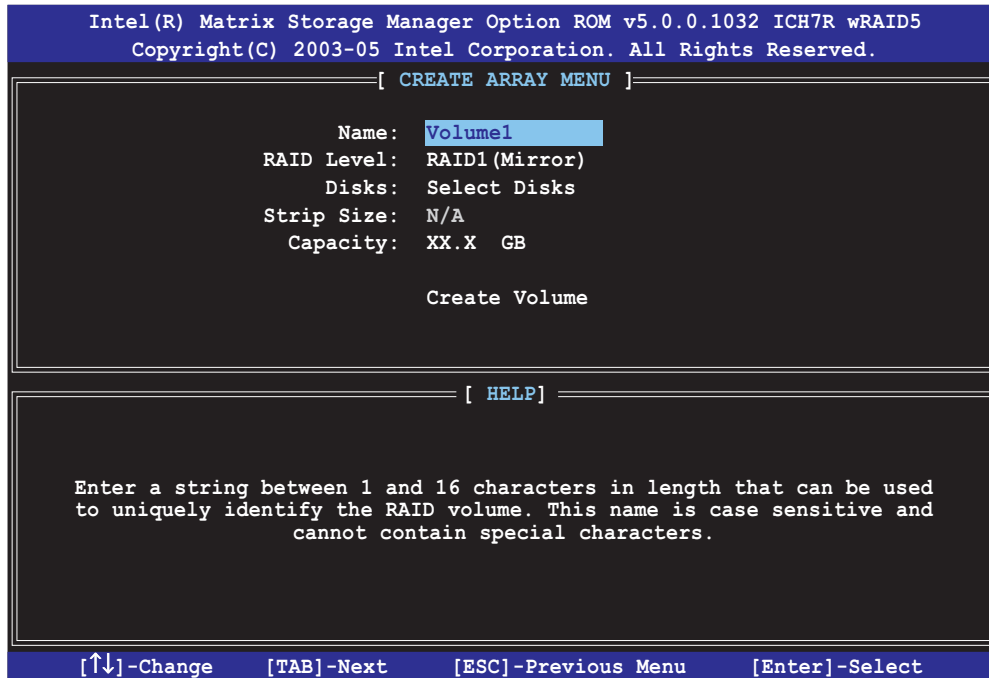

2. Enter a name for the RAID 1 set, then press <Enter>.
3. When the **RAID Level** item is highlighted, press the up/down arrow key to select **RAID 1 (Mirror)**, then press <Enter>.
4. When the **Capacity** item is highlighted, key in the RAID volume capacity that you want, then press <Enter>. The default value indicates the maximum allowed capacity.
5. Press <Enter> when the **Create Volume** item is highlighted. This warning message appears.



6. Press <Y> to create the RAID volume and return to main menu or <N> to go back to Create Volume menu.

- When the RAID volume is created, the main menu displays relevant information about the volume.

```

Intel(R) Matrix Storage Manager option ROM v5.7.0.1005 ICH7MR
Copyright(C) 2003-05 Intel Corporation. All Rights Reserved.

[ MAIN MENU ]
1. Create RAID Volume
2. Delete RAID Volume
3. Reset Disks to Non-RAID
4. Exit

[ DISK/VOLUME INFORMATION ]

RAID Volumes:
ID      Name      Level      Strip      Size      Status      Bootable
0       Volumename RAID1(Mirror) N/A       XXX.XXGB   Normal      Yes

Physical Disks:
Port Drive Model      Serial #      Size      Type/Status(Vol ID)
0  XXXXXXXXXXXX XXXXXXXX     XX.XXGB   Member Disk(0)
2  XXXXXXXXXXXX XXXXXXXX     XX.XXGB   Member Disk(0)

[↑↓]-Select      [ESC]-Exit      [ENTER]-Select Menu

```

Deleting a RAID set



Take caution when deleting a RAID set. You will lose all data on the hard disk drives when you delete a RAID set.

To delete a RAID set:

1. From the utility main menu, select **2. Delete RAID Volume**, then press <Enter> to display this screen.

```
Intel(R) Matrix Storage Manager option ROM v5.7.0.1005 ICH7MR
Copyright(C) 2003-05 Intel Corporation. All Rights Reserved.

[ DELETE VOLUME MENU ]
-----
Name           Level           Drives    Capacity   Status    Bootable
Volume0        RAIDX (xxxxx)   X         XXX.XGB   Normal   Yes
-----

[ HELP ]

Deleting a volume will destroy the volume data on the drive(s) and
cause any member disks to become available as non-RAID disks.

WARNING: EXISTING DATA WITHIN THIS VOLUME WILL BE LOST AND NON-RECOVERABLE.

[↑↓]-Select      [<ESC>]-Previous Menu    [<Del>]-Delete Volume
```

2. Use the up/down arrow key to select the RAID set you want to delete, then press . This window appears.

```
[ DELETE VOLUME VERIFICATION ]
-----
ALL DATA IN THE VOLUME WILL BE LOST!

Are you sure you want to delete volume "VolumeX"? (Y/N):
```

3. Press <Y> to delete the RAID set and return to the utility main menu; otherwise, press <N> to return to the Delete Volume menu.

Resetting disks to Non-RAID



Take caution before you reset a RAID volume HDD to non-RAID. Resetting a RAID volume HDD deletes all internal RAID structure on the drive.

To reset a RAID set hard disk drive:

1. From the utility main menu, select **3. Reset Disks to Non-RAID**, then press <Enter> to display this screen.

```
[ RESET RAID DATA ]

Resetting RAID data will remove internal RAID structures
from the selected RAID disks. By removing these structures,
the drive will revert back to a non-RAID disk.

WARNING: Resetting a disk causes all data on the disk to be lost.

Port Drive Model          Serial #          Size Status
---  -  -  -  -  -  -  -  -  -  -  -  -  -  -  -  -  -  -  -  -  -  -
0  XXXXXXXXXXXX          XXXXXXXX          XX.XGB Member Disk
1  XXXXXXXXXXXX          XXXXXXXX          XX.XGB Member Disk

Select the disks that should be reset.

[↑↓]-Previous/Next [SPACE]-Selects [ENTER]-Selection Complete
```

2. Use the up/down arrow key to highlight the RAID set drive you want to reset, then press <Space> to select.
3. Press <Enter> to reset the RAID set drive. A confirmation message appears.
4. Press <Y> to reset the drive or press <N> to return to the utility main menu.

Exiting the Intel® Matrix Storage Manager utility

To exit the utility:

1. From the utility main menu, select **4. Exit**, then press <Enter>. This window appears.

```
[ CONFIRM EXIT ]

Are you sure you want to exit? (Y/N):
```

2. Press <Y> to exit or press <N> to return to the utility main menu.

5.4.3 JMicron® RAID Configuration

The JMicron® Serial ATA controller allows you to configure RAID 0 and RAID 1 sets on the external Serial ATA hard disk drives.

Before creating a RAID set

Prepare the following items:

1. At two HDDs, preferably with the same model and capacity.
2. A white floppy disk
3. Microsoft® Windows® OS installation disk (Windows 2000/XP/2003)
4. Motherboard support CD with JMB363 driver

Complete the following steps before you create a RAID set:

1. Install the external Serial ATA hard disk drives (HDDs) on your system.
2. Set the **Onboard JMB363 Serial -ATA** item in the BIOS to [RAID]. See section “4.4.4 Onboard Devices Configuration” for details.

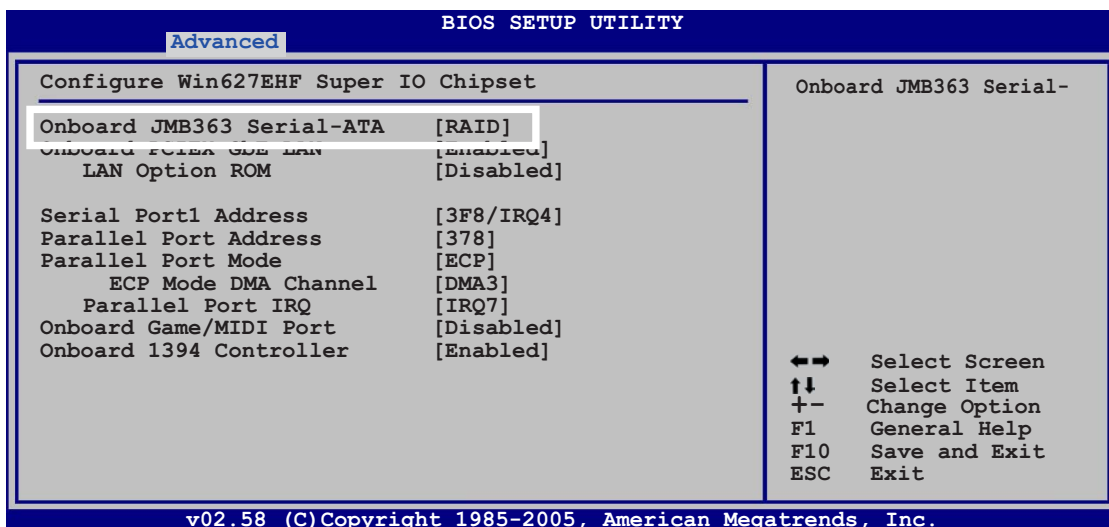

3. Enter the JMB363 RAID BIOS utility to set up your RAID configuration.
4. Create a JMB363 RAID driver disk for Windows® OS installation. See section “5.5 Creating a RAID driver disk” for details.
5. Install the JMB363 driver after the Windows® OS had been installed.

Entering the JMB363 RAID BIOS utility

1. During POST, press <Ctrl-J> to enter the JMB363 RAID BIOS menu.



2. The main JMB363 RAID BIOS menu appears.
3. Use the arrow keys to move the color bar and navigate through the items.

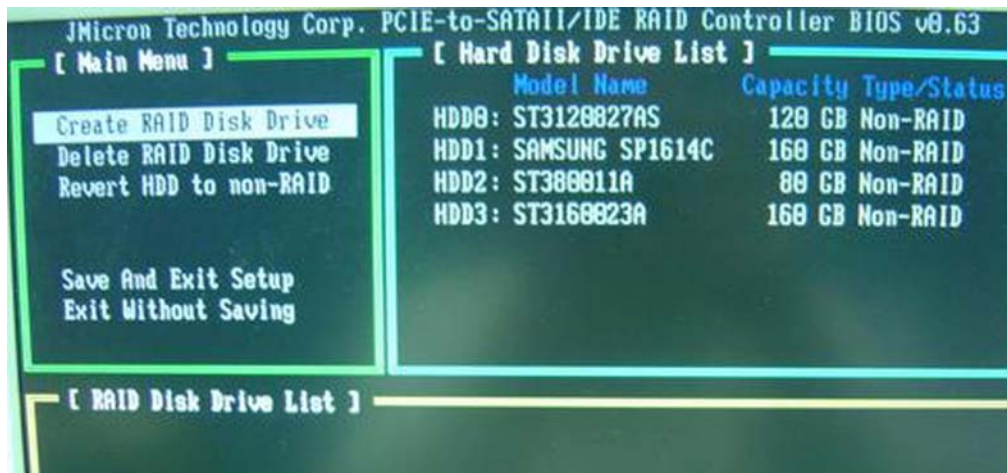

Creating a RAID set

1. In the main JMB363 RAID BIOS menu, highlight **Create RAID Disk Drive** using the up/down arrow key then press <Enter>.



- When the **Level** item is highlighted, use the up/down arrow key to select the RAID set that you want to create.



- When the **Disks** item is highlighted, use the up/down arrow key to highlight an HDD that you want to belong to the RAID set, then press the space bar to confirm selection. Repeat the process until the HDDs are selected.

A selected HDD shows a ► sign before it.

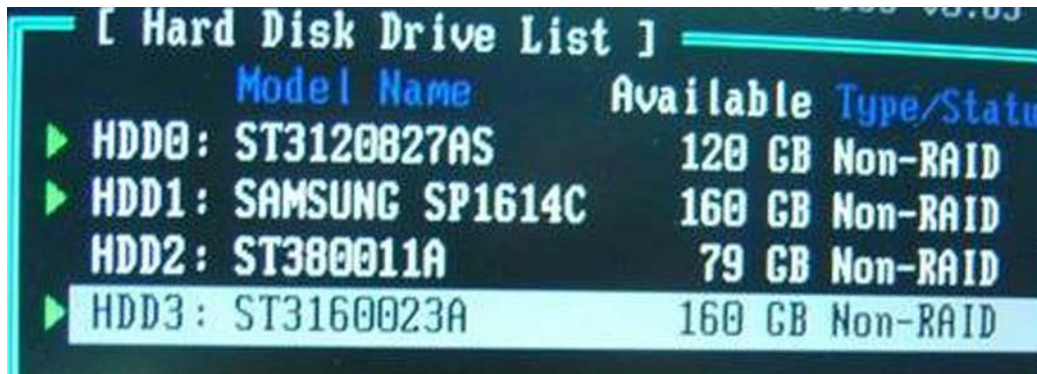

- Key in the RAID volume capacity. Use the up/down arrow to choose the block size. The default value indicates the maximum allowed capacity.



5. When done, press <Enter> to confirm the creation of the RAID set. A dialogue box appears to confirm the action. Press <Y> to confirm; otherwise, press <N>.



Pressing <Y> deletes all the data in the HDDs.

6. The following screen appears, displaying the relevant information about the RAID set you created.

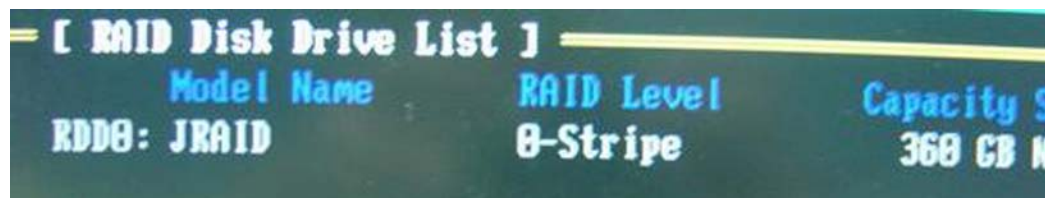

Deleting a RAID set

1. In the main JMB363 RAID BIOS menu, highlight **Delete RAID Disk Drive** using the up/down arrow key then press <Enter>.



2. Use the space bar to select the RAID set you want to delete.
A selected set shows a ► sign before it. Press the key to delete the set.
3. A dialogue box appears to confirm the action. Press <Y> to confirm; otherwise, press <N>.



Pressing <Y> deletes all the data in the HDDs.

Resetting disks to non-RAID



When you install an HDD that has been configured as part of another RAID set, you may convert this broken RAID HDD to non-RAID mode. All original data, however, will be lost.

To prevent damage to your system, you cannot select the HDD when configuring a RAID set through the JMB363 utility.

To reset disks to non-RAID:

1. In the main JMB363 RAID BIOS menu, highlight **Revert HDD to non-RAID** using the up/down arrow key then press <Enter>.



2. Use the space bar to select the HDD that you want to reset to non-RAID.
A selected HDD shows a ► sign before it.
3. A dialogue box appears to confirm the action. Press <Y> to confirm; otherwise, press <N>.

Saving the settings and exiting setup

When you have finished, highlight **Save & Exit Setup** using the up/down arrow key then press <Enter> to save the current RAID configuration and exit the JMB363 RAID BIOS utility.

A dialogue box appears to confirm the action. Press <Y> to confirm; otherwise, press <N> to return to the JMB RAID BIOS menu.

5.5 Creating a RAID driver disk

A floppy disk with the RAID driver is required when installing Windows® 2000/XP and later operating system on a hard disk drive that is included in a RAID set.

To create a RAID driver disk:

1. Place the motherboard support CD into the CD-ROM drive.
2. Select **Make Disk** tab.
3. From the **Make Disk** menu, select the RAID driver disk you want to create or browse the contents of the support CD to locate the driver disk utility.



Refer to section “5.2.4 Make Disk menu” for details.

4. Insert the floppy disk into floppy disk drive.
5. Follow succeeding screen information to complete process.
6. Write-protect the floppy disk to avoid computer virus infection.

To install the RAID driver:

1. During the OS installation, the system prompts you to press the F6 key to install third-party SCSI or RAID driver.
2. Press <F6> then insert the floppy disk with RAID driver into the floppy disk drive.
3. When prompted to select the SCSI adapter to install, make sure you select **Intel(R) 82801GHM SATA RAID Controller (Mobile ICH7MR/DH)** and **JMicron JMB 363**.
4. Follow the succeeding screen instructions to complete the installation.