

**F2A85-M PRO**

**ASUS**<sup>®</sup>

**Motherboard**

**Copyright © 2012 ASUSTeK COMPUTER INC. All Rights Reserved.**

No part of this manual, including the products and software described in it, may be reproduced, transmitted, transcribed, stored in a retrieval system, or translated into any language in any form or by any means, except documentation kept by the purchaser for backup purposes, without the express written permission of ASUSTeK COMPUTER INC. ("ASUS").

Product warranty or service will not be extended if: (1) the product is repaired, modified or altered, unless such repair, modification of alteration is authorized in writing by ASUS; or (2) the serial number of the product is defaced or missing.

ASUS PROVIDES THIS MANUAL "AS IS" WITHOUT WARRANTY OF ANY KIND, EITHER EXPRESS OR IMPLIED, INCLUDING BUT NOT LIMITED TO THE IMPLIED WARRANTIES OR CONDITIONS OF MERCHANTABILITY OR FITNESS FOR A PARTICULAR PURPOSE. IN NO EVENT SHALL ASUS, ITS DIRECTORS, OFFICERS, EMPLOYEES OR AGENTS BE LIABLE FOR ANY INDIRECT, SPECIAL, INCIDENTAL, OR CONSEQUENTIAL DAMAGES (INCLUDING DAMAGES FOR LOSS OF PROFITS, LOSS OF BUSINESS, LOSS OF USE OR DATA, INTERRUPTION OF BUSINESS AND THE LIKE), EVEN IF ASUS HAS BEEN ADVISED OF THE POSSIBILITY OF SUCH DAMAGES ARISING FROM ANY DEFECT OR ERROR IN THIS MANUAL OR PRODUCT.

SPECIFICATIONS AND INFORMATION CONTAINED IN THIS MANUAL ARE FURNISHED FOR INFORMATIONAL USE ONLY, AND ARE SUBJECT TO CHANGE AT ANY TIME WITHOUT NOTICE, AND SHOULD NOT BE CONSTRUED AS A COMMITMENT BY ASUS. ASUS ASSUMES NO RESPONSIBILITY OR LIABILITY FOR ANY ERRORS OR INACCURACIES THAT MAY APPEAR IN THIS MANUAL, INCLUDING THE PRODUCTS AND SOFTWARE DESCRIBED IN IT.

Products and corporate names appearing in this manual may or may not be registered trademarks or copyrights of their respective companies, and are used only for identification or explanation and to the owners' benefit, without intent to infringe.

**Offer to Provide Source Code of Certain Software**

This product contains copyrighted software that is licensed under the General Public License ("GPL"), under the Lesser General Public License Version ("LGPL") and/or other Free Open Source Software Licenses. Such software in this product is distributed without any warranty to the extent permitted by the applicable law. Copies of these licenses are included in this product.

Where the applicable license entitles you to the source code of such software and/or other additional data, you may obtain it for a period of three years after our last shipment of the product, either

(1) for free by downloading it from <http://support.asus.com/download>

or

(2) for the cost of reproduction and shipment, which is dependent on the preferred carrier and the location where you want to have it shipped to, by sending a request to:

ASUSTeK Computer Inc.  
Legal Compliance Dept.  
15 Li Te Rd.,  
Beitou, Taipei 112  
Taiwan

In your request please provide the name, model number and version, as stated in the About Box of the product for which you wish to obtain the corresponding source code and your contact details so that we can coordinate the terms and cost of shipment with you.

The source code will be distributed WITHOUT ANY WARRANTY and licensed under the same license as the corresponding binary/object code.

This offer is valid to anyone in receipt of this information.

ASUSTeK is eager to duly provide complete source code as required under various Free Open Source Software licenses. If however you encounter any problems in obtaining the full corresponding source code we would be much obliged if you give us a notification to the email address [gpl@asus.com](mailto:gpl@asus.com), stating the product and describing the problem (please DO NOT send large attachments such as source code archives, etc. to this email address).

# Contents

Safety information.....	vii
About this guide.....	viii
F2A85-M PRO specifications summary .....	x
Package contents.....	xiv
Installation tools and components.....	xv

## Product introduction

<b>1.1</b>	<b>Special features.....</b>	<b>1-1</b>
1.1.1	Product highlights.....	1-1
1.1.2	Dual Intelligent Processors 2 – DIGI+ VRM.....	1-2
1.1.3	ASUS Exclusive Features.....	1-2
<b>1.2</b>	<b>Motherboard overview.....</b>	<b>1-5</b>
1.2.1	Before you proceed.....	1-5
1.2.2	Motherboard layout.....	1-6
1.2.3	System memory.....	1-8
1.2.4	Expansion slots.....	1-16
1.2.5	Onboard switches and buttons.....	1-18
1.2.6	Jumpers.....	1-21
1.2.7	Onboard LEDs.....	1-22
1.2.8	Internal connectors.....	1-24

## Basic Installation

<b>2.1</b>	<b>Building your PC system.....</b>	<b>2-1</b>
2.1.1	Motherboard installation.....	2-1
2.1.2	APU installation.....	2-4
2.1.3	CPU heatsink and fan assembly installation.....	2-5
2.1.4	DIMM installation.....	2-8
2.1.5	ATX Power connection.....	2-9
2.1.6	SATA device connection.....	2-10
2.1.7	Expansion Card installation.....	2-11
<b>2.2</b>	<b>BIOS update utility.....</b>	<b>2-12</b>
2.2.1	USB BIOS Flashback.....	2-12
<b>2.3</b>	<b>Motherboard rear and audio connections.....</b>	<b>2-13</b>
2.3.1	Rear I/O connection.....	2-13
2.3.2	Audio I/O connections.....	2-15
<b>2.4</b>	<b>Starting up for the first time.....</b>	<b>2-17</b>
<b>2.5</b>	<b>Turning off the computer.....</b>	<b>2-17</b>

## BIOS setup

<b>3.1</b>	<b>Knowing BIOS</b> .....	<b>3-1</b>
<b>3.2</b>	<b>BIOS setup program</b> .....	<b>3-2</b>
3.2.1	EZ Mode .....	3-3
3.2.2	Advanced Mode .....	3-4
<b>3.3</b>	<b>Main menu</b> .....	<b>3-6</b>
<b>3.4</b>	<b>Ai Tweaker menu</b> .....	<b>3-8</b>
3.4.1	Ai Overclock Tuner [Auto] .....	3-9
3.4.2	Memory Frequency [Auto] .....	3-9
3.4.3	APU Multiplier [Auto] .....	3-9
3.4.4	NB Frequency [Auto] .....	3-9
3.4.5	EPU Power Saving Mode [Disabled] .....	3-9
3.4.6	GPU Boost .....	3-10
3.4.7	OC Tuner .....	3-10
3.4.8	DRAM Timing Control .....	3-10
3.4.9	DIGI + VRM .....	3-10
3.4.10	CPU Voltage [Offset Mode] .....	3-11
3.4.11	DRAM Voltage [Auto] .....	3-12
3.4.12	SB 1.1V Voltage [Auto] .....	3-12
3.4.13	1.1Vsb Voltage [Auto] .....	3-12
3.4.14	APU1.2V Voltage [Auto] .....	3-12
3.4.15	VDDA Voltage [Auto] .....	3-12
3.4.16	NB VREF Voltage [Auto] .....	3-12
3.4.17	DRAM VREFCA Voltage [Auto] .....	3-12
3.4.18	DRAM VREFDQ Voltage [Auto] .....	3-13
3.4.19	CPU Spread Spectrum [Auto] .....	3-13
<b>3.5</b>	<b>Advanced menu</b> .....	<b>3-14</b>
3.5.1	CPU Configuration .....	3-14
3.5.2	SATA Configuration .....	3-15
3.5.3	USB Configuration .....	3-16
3.5.4	NB Configuration .....	3-16
3.5.5	Onboard Devices Configuration .....	3-17
3.5.6	APM .....	3-18
3.5.7	Network Stack .....	3-19
<b>3.6</b>	<b>Monitor menu</b> .....	<b>3-20</b>
3.6.1	CPU Temperature / MB Temperature [xxx°C/xxx°F] .....	3-20
3.6.2	CPU_FAN Speed [xxxx RPM] or [Ignore] / [N/A] .....	3-20
	CHA_FAN1/2/3 Speed [xxxx RPM] or [Ignore] / [N/A] .....	3-20



3.6.3	CPU Voltage, 3.3V Voltage, 5V Voltage, 12V Voltage .....	3-20
3.6.4	CPU_FAN Q-Fan Control [Disabled].....	3-21
3.6.5	CHA_FAN1/2/3 Q-Fan Control [Enabled].....	3-22
3.6.6	Anti Surge Support [Enabled].....	3-22
<b>3.7</b>	<b>Boot menu .....</b>	<b>3-23</b>
3.7.1	Bootup NumLock State [On] .....	3-23
3.7.2	Full Screen Logo [Enabled].....	3-23
3.7.3	Fast Boot [Enabled].....	3-23
3.7.4	Post Logo Delay Time [3 sec] .....	3-24
3.7.5	Wait for 'F1' If Error [Enabled].....	3-24
3.7.6	DirectKey Enable [Go to BIOS...].	3-24
3.7.7	Option ROM Messages [Force BIOS].....	3-24
3.7.8	Next boot after AC Power Loss [Normal Boot] .....	3-24
3.7.9	CSM Parameters.....	3-24
3.7.10	Security Boot parameters.....	3-25
3.7.11	Setup Mode [EZ Mode].....	3-26
3.7.12	Boot Option Priorities .....	3-26
3.7.13	Boot Override.....	3-26
<b>3.8</b>	<b>Tools menu .....</b>	<b>3-27</b>
3.8.1	ASUS EZ Flash 2 Utility .....	3-27
3.8.2	ASUS SPD Information.....	3-27
3.8.3	ASUS O.C. Profile.....	3-27
<b>3.9</b>	<b>Exit menu .....</b>	<b>3-28</b>

## Software support

<b>4.1</b>	<b>Installing an operating system .....</b>	<b>4-1</b>
<b>4.2</b>	<b>Support DVD information .....</b>	<b>4-1</b>
4.2.1	Running the support DVD .....	4-1
4.2.2	Obtaining the software manuals.....	4-2
<b>4.3</b>	<b>Software information .....</b>	<b>4-3</b>
4.3.1	AI Suite II.....	4-3
4.3.2	TurboV EVO.....	4-4
4.3.3	DIGI+ VRM.....	4-9
4.3.4	EPU.....	4-11
4.3.5	FAN Xpert 2.....	4-12
4.3.6	USB Charger+.....	4-17
4.3.7	USB 3.0 Boost.....	4-19
4.3.8	USB BIOS Flashback Wizard.....	4-20
4.3.9	Ai Charger+ .....	4-22

4.3.10	Probe II.....	4-23
4.3.11	Sensor Recorder.....	4-24
4.3.12	ASUS Update.....	4-26
4.3.13	MyLogo2.....	4-27
4.3.14	Audio configurations.....	4-28
4.3.15	Network iControl.....	4-30
4.3.16	Remote GO!.....	4-34

## RAID support

<b>5.1</b>	<b>RAID configurations .....</b>	<b>5-1</b>
5.1.1	RAID definitions .....	5-1
5.1.2	Installing Serial ATA hard disks .....	5-2
5.1.3	Setting the RAID item in BIOS.....	5-2
5.1.4	AMD® Option ROM utility .....	5-3
<b>5.2</b>	<b>Creating a RAID driver disk.....</b>	<b>5-6</b>
5.2.1	Creating a RAID driver disk without entering the OS.....	5-6
5.2.2	Creating a RAID driver disk in Windows®.....	5-6
5.2.3	Installing the RAID driver during Windows® OS installation.....	5-7
5.2.4	Using a USB floppy disk drive.....	5-8

## Multiple GPU support

<b>6.1</b>	<b>AMD® CrossFireX™ technology .....</b>	<b>6-1</b>
6.1.1	Requirements.....	6-1
6.1.2	Before you begin.....	6-1
6.1.3	Installing two CrossFireX™ graphics cards .....	6-2
6.1.4	Installing the device drivers.....	6-3
6.1.5	Enabling the AMD® CrossFireX™ technology.....	6-3
<b>6.2</b>	<b>AMD® Dual Graphics technology.....</b>	<b>6-5</b>
6.2.1	System requirements .....	6-5
6.2.2	Before you proceed.....	6-5
6.2.3	Installing AMD Chipset Driver .....	6-5
6.2.4	Using the AMD® CATALYST® Control Center.....	6-6
<b>6.3</b>	<b>LucidLogix Virtu MVP.....</b>	<b>6-8</b>
6.3.1	Installing LucidLogix Virtu MVP.....	6-8
6.3.2	Setting up your display.....	6-9
6.3.3	Configuring LucidLogix Virtu MVP .....	6-10

## Appendices

<b>Notices .....</b>	<b>A-1</b>
<b>ASUS contact information.....</b>	<b>A-4</b>

# Safety information

## Electrical safety

- To prevent electrical shock hazard, disconnect the power cable from the electrical outlet before relocating the system.
- When adding or removing devices to or from the system, ensure that the power cables for the devices are unplugged before the signal cables are connected. If possible, disconnect all power cables from the existing system before you add a device.
- Before connecting or removing signal cables from the motherboard, ensure that all power cables are unplugged.
- Seek professional assistance before using an adapter or extension cord. These devices could interrupt the grounding circuit.
- Ensure that your power supply is set to the correct voltage in your area. If you are not sure about the voltage of the electrical outlet you are using, contact your local power company.
- If the power supply is broken, do not try to fix it by yourself. Contact a qualified service technician or your retailer.

## Operation safety

- Before installing the motherboard and adding devices on it, carefully read all the manuals that came with the package.
- Before using the product, ensure all cables are correctly connected and the power cables are not damaged. If you detect any damage, contact your dealer immediately.
- To avoid short circuits, keep paper clips, screws, and staples away from connectors, slots, sockets and circuitry.
- Avoid dust, humidity, and temperature extremes. Do not place the product in any area where it may become wet.
- Place the product on a stable surface.
- If you encounter technical problems with the product, contact a qualified service technician or your retailer.

## About this guide

This user guide contains the information you need when installing and configuring the motherboard.

## How this guide is organized

This guide contains the following parts:

- **Chapter 1: Product introduction**  
This chapter describes the features of the motherboard and the new technology it supports. It includes description of the switches, jumpers, and connectors on the motherboard.
- **Chapter 2: Basic Installation**  
This chapter lists the hardware setup procedures that you have to perform when installing system components.
- **Chapter 3: BIOS setup**  
This chapter tells how to change system settings through the BIOS Setup menus. Detailed descriptions of the BIOS parameters are also provided.
- **Chapter 4: Software support**  
This chapter describes the contents of the support DVD that comes with the motherboard package and the software.
- **Chapter 5: RAID support**  
This chapter describes the RAID configurations.
- **Chapter 6: Multiple GPU technology support**  
This chapter describes how to install and configure multiple ATI® CrossFireX™ graphics cards.

## Where to find more information

Refer to the following sources for additional information and for product and software updates.

1. **ASUS websites**  
The ASUS website provides updated information on ASUS hardware and software products. Refer to the ASUS contact information.
2. **Optional documentation**  
Your product package may include optional documentation, such as warranty flyers, that may have been added by your dealer. These documents are not part of the standard package.

## Conventions used in this guide

To ensure that you perform certain tasks properly, take note of the following symbols used throughout this manual.



**DANGER/WARNING:** Information to prevent injury to yourself when trying to complete a task.



**CAUTION:** Information to prevent damage to the components when trying to complete a task.



**IMPORTANT:** Instructions that you **MUST** follow to complete a task..



**NOTE:** Tips and additional information to help you complete a task.

## Typography

**Bold text**

Indicates a menu or an item to select.

*Italics*

Used to emphasize a word or a phrase.

<Key>

Keys enclosed in the less-than and greater-than sign means that you must press the enclosed key.

Example: <Enter> means that you must press the Enter or Return key.

<Key1> + <Key2> + <Key3>

If you must press two or more keys simultaneously, the key names are linked with a plus sign (+).

## F2A85-M PRO specifications summary

<b>APU</b>	<p>AMD® A-series accelerated processors with AMD® Radeon™ HD 7000 series graphics, up to 4 CPU cores, FM2 package</p> <p>AMD® Turbo Core Technology 3.0 support</p> <ul style="list-style-type: none"> <li>• The AMD® Turbo Core Technology 3.0 support depends on the APU types.</li> <li>• Refer to <a href="http://www.asus.com">www.asus.com</a> for the AMD® CPU support list</li> </ul>
<b>Chipset</b>	AMD® A85X FCH (Hudson D4)
<b>Memory</b>	<p>Dual-channel memory architecture</p> <p>4 x 240-pin DIMM slots support maximum 64GB unbuffered non-ECC DDR3 2400(O.C.)/1866/1600/1333/1066 MHz memory modules</p> <ul style="list-style-type: none"> <li>• The maximum 64GB memory capacity can be supported with 16GB or above DIMMs. ASUS will update the memory QVL once the DIMMs are available in the market.</li> <li>• Refer to <a href="http://www.asus.com">www.asus.com</a> for the latest Memory QVL (Qualified Vendors List).</li> <li>• When you install a total memory of 4GB capacity or more, Windows® 32-bit operating system may only recognize less than 3GB. We recommend a maximum of 3GB system memory if you are using a Windows® 32-bit operating system.</li> </ul>
<b>Graphics</b>	<p>Integrated AMD® Radeon™ HD 7000 series graphics in Trinity APU</p> <p>Multi-VGA output support: DisplayPort / HDMI / DVI / RGB port</p> <ul style="list-style-type: none"> <li>- Supports DisplayPort with max. resolution up to 4096 x 2160 @60Hz</li> <li>- Supports HDMI with max. resolution up to 1920 x 1080 @60Hz</li> <li>- Supports dual-link DVI with max. resolution up to 2560 x 1600 @60Hz</li> <li>- Supports D-Sub with max. resolution up to 1920 x 1600 @60Hz</li> <li>- Supports Microsoft® DirectX 11</li> <li>- Maximum shared memory of 2G</li> <li>- Supports AMD® Dual Graphics technology</li> </ul> <p>* Refer to <a href="http://www.amd.com">www.amd.com</a> for the discrete GPUs that support Dual Graphics technology.</p>
<b>Expansion slots</b>	<p>2 x PCIe 2.0 x16 slots (Single @x16 or dual @x8x8 mode)</p> <p>2 x PCIe 2.0 x1 slots</p>
<b>Storage / RAID</b>	<p><b>AMD® A85X FCH:</b></p> <ul style="list-style-type: none"> <li>- 7 x Serial ATA 6.0Gb/s connectors support RAID 0, RAID 1, RAID 5, RAID 10 and JBOD configurations</li> <li>- 1 x eSerial ATA 6Gb/s at the back I/O</li> </ul>
<b>LAN</b>	Realtek® RTL8111F PCIe Gigabit LAN controller
<b>Audio</b>	<p><b>ALC892 8-channel High Definition Audio CODEC</b></p> <ul style="list-style-type: none"> <li>- Supports Jack-Detection, Multi-Streaming, and Front Panel Jack-Retasking</li> <li>- Supports S/PDIF out interface at the back I/O</li> </ul>

(continued on the next page)

# F2A85-M PRO specifications summary

<b>USB</b>	<b>AMD® A85X FCH:</b> <ul style="list-style-type: none"><li>- 10 x USB 2.0 ports (8 ports at the mid-board, 2 ports at the back panel)</li><li>- 4 x USB 3.0 ports (2 ports at the mid-board, 2 ports at the back panel)</li></ul> <b>Asmedia® PCIe USB3.0 controller:</b> <ul style="list-style-type: none"><li>- 2 x USB 3.0 ports (blue, at the back panel)</li></ul> <p>* Supports ASUS USB 3.0 Boost UASP Mode</p>
<b>ASUS unique features</b>	<b>ASUS Dual Intelligent Processors II – TPU &amp; EPU</b> <ul style="list-style-type: none"><li>- Auto Tuning, TurboV, EPU and TPU switch</li></ul> <b>ASUS Digital Power Design</b> <ul style="list-style-type: none"><li>- Industry leading Digital 4+2 Phase Power Design</li></ul> <b>ASUS EPU</b> <ul style="list-style-type: none"><li>- EPU, EPU switch</li></ul> <b>ASUS TPU</b> <ul style="list-style-type: none"><li>- Auto Tuning, TurboV, GPU Boost, TPU switch</li></ul> <b>ASUS Exclusive Features</b> <ul style="list-style-type: none"><li>- ASUS USB 3.0</li><li>- ASUS Remote Go!</li><li>- ASUS Network iControl</li><li>- ASUS USB Charger+</li><li>- ASUS AI Charger+</li><li>- Disk Unlocker</li><li>- ASUS MemOK!</li><li>- ASUS AI Suite II</li><li>- ASUS Anti-Surge</li><li>- ASUS Low EMI</li><li>- ASUS ESD</li></ul> <b>ASUS Quiet Thermal Solution</b> <ul style="list-style-type: none"><li>- ASUS Fanless Design: Stylish heatsink solution</li><li>- ASUS Fan Xpert 2</li></ul> <b>ASUS EZ DIY</b> <ul style="list-style-type: none"><li>- ASUS USB BIOS Flashback</li><li>- ASUS UEFI BIOS EZ Mode</li><li>- ASUS CrashFree BIOS 3</li><li>- ASUS EZ Flash 2</li><li>- ASUS My Logo 2</li></ul> <b>ASUS Q Design</b> <ul style="list-style-type: none"><li>- ASUS Q-Slot, Q-Shield</li></ul>
<b>Special features</b>	100% All high quality conductive polymer capacitors

(continued on the next page)

## F2A85-M PRO specifications summary

<b>Back Panel I/O ports</b>	1 x PS/2 keyboard / mouse combo port 1 x DisplayPort 1 x HDMI output port 1 x DVI output port 1 x D-Sub output port 1 x Optical S/PDIF output port 1 x LAN (RJ-45) port 1 x eSATA port 2 x USB 2.0 ports 4 x USB 3.0/2.0 ports (blue, 1 port supports USB BIOS Flashback) 8-channel audio I/O ports
<b>ASUS exclusive overclocking features</b>	<b>Intelligent overclocking tools:</b> <ul style="list-style-type: none"><li>- TPU Switch</li><li>- Auto Tuning</li></ul> <b>Precision Tweaker 2</b> <ul style="list-style-type: none"><li>- vCore: Adjustable CPU voltage at 0.00625V increment</li><li>- vDDNB: Adjustable CPU/NB voltage at 0.00625V increment</li><li>- vDRAM Bus: Adjustable DRAM voltage at 0.005V increment</li><li>- vFCH: Adjustable FCH voltage at 0.01V increment</li></ul> <b>SFS (Stepless Frequency Selection):</b> <ul style="list-style-type: none"><li>- APU frequency tuning from 90MHz up to 300MHz at 1MHz increment</li></ul> <b>Overclocking Protection:</b> <ul style="list-style-type: none"><li>- ASUS C.P.R (CPU Parameter Recall)</li></ul>
<b>Internal I/O connectors / buttons / switches</b>	4 x USB 2.0 connectors support additional 8 USB ports 1 x USB 3.0 connector supports additional 2 USB ports 7 x SATA 6.0Gb/s connectors 1 x S/PDIF output connector 1 x Front panel audio connector 1 x COM connector 1 x EPU switch 1 x TPU switch (embedded with GPU switch) 1 x USB BIOS Flashback switch 1 x MemOK! button 1 x DirectKey button 1 x DRCT header 1 x System panel connector 1 x TPM connector 1 x CPU fan connector 3 x Chassis fan connectors 1 x 24-pin EATX power connector 1 x 8-pin EATX 12V power connector

*(continued on the next page)*



## F2A85-M PRO specifications summary

<b>BIOS</b>	64Mb Flash ROM, UEFI BIOS, PnP, DMI 2.0, WfM 2.0, SM BIOS V2.7, ACPI 2.0a
<b>Accessories</b>	2 x Serial ATA 6.0Gb/s cables 1 x Q-Shield 1 x User Manual 1 x Support DVD
<b>Support DVD</b>	Drivers ASUS Update ASUS utilities Anti-Virus software (OEM version)
<b>Form factor</b>	uATX form factor: 9.6 in x 9.6 in (24.4 cm x 24.4 cm)





---

Specifications are subject to change without notice.

---

## Package contents

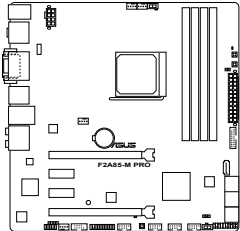

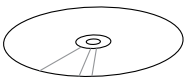
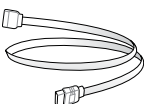
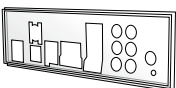

Check your motherboard package for the following items.

		
<b>ASUS F2A85-M PRO motherboard</b>		<b>User Guide</b>
		
<b>Support DVD</b>	<b>2 x Serial ATA 6.0 Gb/s cables</b>	<b>1 x ASUS Q-Shield</b>

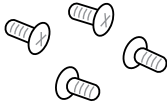

- If any of the above items is damaged or missing, contact your retailer.
- The illustrated items above are for reference only. Actual product specifications may vary with different models.

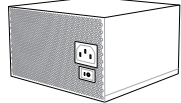
# Installation tools and components

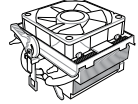
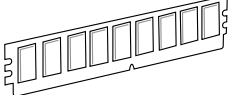
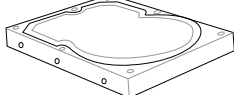
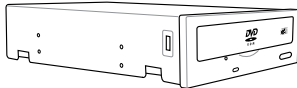
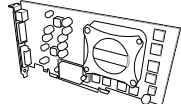
	
<b>1 bag of screws</b>	<b>Phillips (cross) screwdriver</b>
	
<b>PC chassis</b>	<b>Power supply unit</b>
	
<b>AMD FM2 APU</b>	<b>AMD FM2 compatible CPU Fan</b>
	
<b>DIMM</b>	<b>SATA hard disk drive</b>
	
<b>SATA optical disc drive (optional)</b>	<b>Graphics card (optional)</b>



The tools and components in the table above are not included in the motherboard package.



# Product introduction

# 1

## 1.1 Special features

### 1.1.1 Product highlights

#### **AMD® A-series accelerated processors with AMD® Radeon™ HD 7000 series graphics**

This motherboard supports AMD® A- series accelerated processor with AMD® Radeon™ HD 7000 series graphics. This revolutionary APU (Accelerated Processing Unit) combines processing power and advanced DirectX 11 graphics in one small, energy-efficient design to enable accelerated performance and an industry-leading visual experience. It features Dual-channel DDR3 memory support and accelerates data transfer rate up to 5GT/s.

#### **AMD® A85X FCH (Hudson D4) Chipset**

AMD® A85X FCH (Hudson D4) is designed to support up to 5GT/s interface speed and PCI Express™ 2.0 x 16 graphics. It supports 8 x SATA 6Gb/s ports and 4 x USB 3.0 ports.

#### **ATI® CrossFireX™ Technology**

ATI's CrossFireX™ boosts image quality along with rendering speed, eliminating the need to scale down screen resolution to get high quality images. CrossFireX™ allows higher antialiasing, anisotropic filtering, shading, and texture settings. Adjust your display configurations, experiment with the advanced 3D settings, and check the effects with a real-time 3D-rendered previews within ATI Catalyst™ Control Center.

#### **Complete USB 3.0 integration**

This motherboard offers you the strategic USB 3.0 accessibility for both the front and rear panels, allowing you to experience the convenience of the latest plug and play connectivity solution at speed up to ten times faster than USB 2.0.

#### **Native SATA 6.0 Gb/s support**

With AMD® A85X FCH natively support for the next-generation Serial ATA (SATA) storage interface, this motherboard delivers up to 6.0 Gb/s data transfer rates. It also provides enhanced scalability, faster data retrieval, double the bandwidth of current bus systems.

#### **100% All High-quality Conductive Polymer Capacitors**

This motherboard uses all high-quality conductive polymer capacitors for durability, improved lifespan, and enhanced thermal capacity.

## 1.1.2 Dual Intelligent Processors 2 – DIGI+ VRM

Together with the ASUS pioneered twin onboard chips, TPU (TurboV Processing Unit) and EPU (Energy Processing Unit), ASUS Dual Intelligent Processors feature DIGI+VRM, which launches power delivery into a digital standard with a programmable microprocessor that perfectly serves power signal, eliminating digital-to-analog conversion lag. With DIGI+VRM, you can easily adjust the power phase performance and system voltages via diverse settings to maximize the motherboard's overall performance and overclocking potential.

### TPU

TPU (TurboV Processing Unit) offers precise voltage control and advanced monitoring mechanisms through the Auto Tuning and TurboV functions.

### EPU

EPU (Energy Processing Unit), the world's first real-time system power-saving chip, automatically detects the current system load and intelligently moderates power usage. It offers a total system-wide energy optimization, reduces fan noise, and extends the component's lifespan.

## 1.1.3 ASUS Exclusive Features

### ASUS DirectKey

This feature allows your system to go to the BIOS Setup program with the press of a button. With DirectKey, you can enter the BIOS anytime without having to press the <Del> key during POST. It also allows you to turn on and turn off your system and conveniently enter the BIOS during bootup.

### ASUS TurboV

With its user-friendly interface, ASUS TurboV offers you the adrenaline rush of real-time overclocking without exiting or rebooting the OS. It also provides you with the ASUS OC profiles for the best overclocking settings in different scenarios.

### Auto Tuning

Auto Tuning is an intelligent tool that automates overclocking to achieve a total system level up. This tool also provides stability testing. Even O.C. beginners can achieve extreme yet stable overclocking results with Auto Tuning!

### MemOK!

MemOK!, the remarkable memory rescue tool, allows you to simply press a button to patch memory issues, ensure memory boot compatibility, determine fail-safe settings, and dramatically improve the system's bootup.

### ASUS Anti-Surge Protection

This special design protects expensive devices and the motherboard from damage caused by power surges from switching power supply unit (PSU).

## ASUS UEFI BIOS (EZ Mode)

ASUS UEFI BIOS, a UEFI compliant architecture, offers the first mouse-controlled intuitive graphical BIOS interface that goes beyond the traditional keyboard-only BIOS controls, providing you with more flexibility, convenience, and easy to navigate UEFI BIOS than the traditional BIOS versions. It offers you with dual selectable modes and native support for hard drives larger than 2.2 TB.

ASUS UEFI BIOS includes the following new features:

- F12 BIOS snapshot hotkey
- F3 Shortcut for most accessed information
- ASUS DRAM SPD (Serial Presence Detect) information detecting faulty DIMMs, and helping with difficult POST situations.

## AI Suite II

With its user interface, ASUS AI Suite II integrates several ASUS utilities and allows you to launch and operate these utilities simultaneously. It allows you to configure the overclocking settings, adjust the frequencies and related voltages, remotely control the system via a mobile device, and other easy-to-use helpful utilities.

## Ai Charger+

ASUS Ai Charger+, the latest Ai Charger\* version, brings you to a new level of USB3.0 fast charging experience. With its easy and user-friendly interface, you can easily charge iPod, iPhone, iPad, but also BC 1.1\*\* standard mobile devices three times\*\*\* as fast as before.



---

\* Ai Charger is ASUS unique fast-charging software that supports iPod, iPhone and iPad.

\*\* Check your USB mobile device manufacturer if it fully supports the BC 1.1 function.

\*\*\* The actual charging speed may vary with your USB device's conditions.

---

## Fanless Design: stylish heatsink solution

The stylish heatsink features a 0-dB thermal solution that offers you a noiseless PC environment. The heatsink design also lowers the temperature of the chipset and power phase area through high efficient heat-exchange. Combined with usability and aesthetics, the ASUS stylish heatsink will give you an extremely silent and cooling experience with the elegant appearance!

## ASUS Fan Xpert 2

ASUS Fan Xpert 2 provides customizable settings for a cooler and quieter computing environment. With its Fan Auto Tuning feature, ASUS Fan Xpert 2 automatically detects and tweaks all fan speeds, and provides you with optimized fan settings based on the fans' specifications and positions.

## **ASUS Q-Design**

ASUS Q-Design enhances your DIY experience. All of Q-Slot and Q-Shield design speed up and simplify the DIY process.

## **ASUS Q-Shield**

ASUS Q-Shield's special design makes it convenient and easy to install on your motherboard. With better electric conductivity, it ideally protects your motherboard against static electricity and shields it against Electronic Magnetic Interference (EMI).

## **ASUS EZ Flash 2**

ASUS EZ Flash 2 is a user-friendly utility that allows you to update the BIOS without using a bootable floppy disk or an OS-based utility.

## **ASUS MyLogo 2™**

Turn your favorite photos into 256-color boot logos to personalize your system.

## **ASUS CrashFree BIOS 3**

ASUS CrashFree BIOS 3 allows you to restore a corrupted BIOS file from a USB storage device that contains the BIOS file.

## **C.P.R. (CPU Parameter Recall)**

The BIOS C.P.R. feature automatically restores the CPU default settings when the system hangs due to overclocking failure. C.P.R. eliminates the need to open the system chassis and clear the RTC data. Simply shut down and reboot the system, and the BIOS automatically restores the CPU parameters to their default settings.

## **USB BIOS Flashback**

USB BIOS Flashback offers a hassle-free updating solution for your ultimate convenience. Install a USB storage device containing the BIOS file, press the BIOS Flashback button for about three seconds, and the UEFI BIOS is automatically updated even without entering the existing BIOS or operating system. It also allows you to regularly check for UEFI BIOS updates, and download the latest BIOS automatically.

## **Network iControl**

Network iControl is an intuitive one-step network control center that makes it easier for you to manage your bandwidth and allows you to set, monitor, and schedule the bandwidth priorities for your network programs. It allows you to automatically connect to a PPPoE network for a more convenient online experience.

## **ErP ready**

The motherboard is European Union's Energy-related Products (ErP) ready, and ErP requires products to meet certain energy efficiency requirements in regards to energy consumptions. This is in line with ASUS vision of creating environment-friendly and energy-efficient products through product design and innovation to reduce carbon footprint of the product and thus mitigate environmental impacts.



## 1.2 Motherboard overview

### 1.2.1 Before you proceed

Take note of the following precautions before you install motherboard components or change any motherboard settings.



- 
- Unplug the power cord from the wall socket before touching any component.
  - Before handling components, use a grounded wrist strap or touch a safely grounded object or a metal object, such as the power supply case, to avoid damaging them due to static electricity.
  - Hold components by the edges to avoid touching the ICs on them.
  - Whenever you uninstall any component, place it on a grounded antistatic pad or in the bag that came with the component.
  - Before you install or remove any component, switch off the ATX power supply and detach its power cord. Failure to do so may cause severe damage to the motherboard, peripherals, or components.
-

## 1.2.2 Motherboard layout

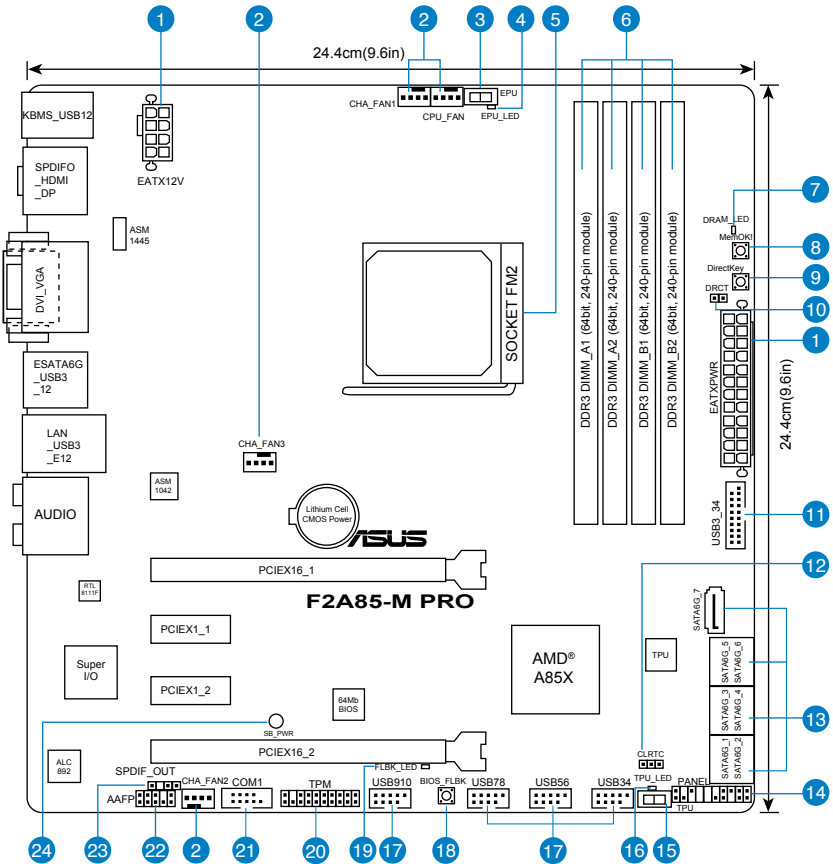

Refer to [1.2.8 Internal connectors](#) and [2.3.1 Rear I/O connection](#) for more information about rear panel connectors and internal connectors.

## Layout contents

Connectors/Jumpers/Slots/LED	Page
1. ATX power connectors (24-pin EATXPWR, 8-pin EATX12V)	1-25
2. CPU and chassis fan connectors (4-pin CPU_FAN and 4-pin CHA_FAN1/2/3)	1-24
3. EPU switch	1-20
4. EPU LED (EPU_LED)	1-23
5. AMD FM2 socket	2-4
6. DDR3 DIMM slots	1-8
7. DRAM LED (DRAM_LED)	1-22
8. MemOK! switch	1-19
9. DirectKey button	1-18
10. Direct connector (2-pin DRCT)	1-30
11. USB 3.0 connector (20-1 pin USB3_34)	1-29
12. Clear RTC RAM (3-pin CLRRTC)	1-21
13. SATA 6.0Gb/s connectors (7-pin SATA6G_1~7)	1-26
14. System panel connector (20-8 pin PANEL)	1-28
15. TPU switch	1-20
16. TPU LED (TPU_LED)	1-22
17. USB 2.0 connectors (10-1 pin USB34, USB56, USB78, USB910)	1-30
18. BIOS Flashback button	1-20
19. BIOS Flashback LED (FLBK_LED)	1-23
20. TPM connector (20-1 pin TPM)	1-31
21. Serial port connector (10-1 pin COM1)	1-27
22. Front panel audio connector (10-1 pin AAFP)	1-29
23. Digital audio connector (4-1 pin SPDIF_OUT)	1-27
24. Standby power LED (SB_PWR)	1-22

### 1.2.3 System memory

This motherboard comes with four Double Data Rate 3 (DDR3) Dual Inline Memory Modules (DIMM) sockets. A DDR3 module has the same physical dimensions as a DDR2 DIMM but is notched differently to prevent installation on a DDR2 DIMM socket. DDR3 modules are developed for better performance with less power consumption. The figure illustrates the location of the DDR3 DIMM sockets:

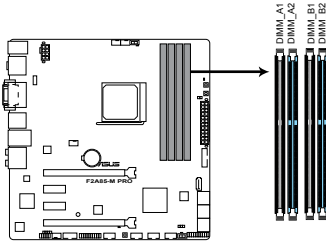

F2A85-M PRO 240-pin DDR3 DIMM sockets

#### Recommended memory configurations

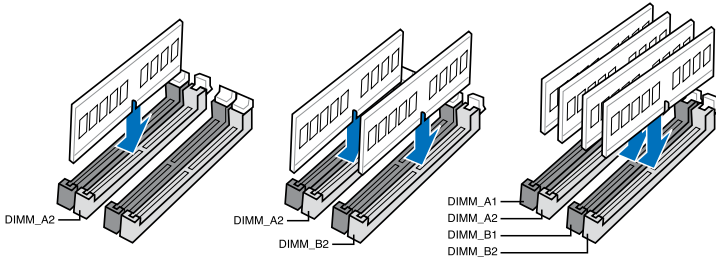

## Memory configurations

You may install 1GB, 2GB, 4GB, and 8GB unbuffered non-ECC DDR3 DIMMs into the DIMM sockets.



- Memory module with memory frequency higher than 2133 MHz and its corresponding timing or the loaded XMP Profile is not the JEDEC memory standard. The stability and compatibility of these memory modules depend on the CPU's capabilities and other installed devices.
- You may install varying memory sizes in Channel A and Channel B. The system maps the total size of the lower-sized channel for the dual-channel configuration. Any excess memory from the higher-sized channel is then mapped for single-channel operation.
- We recommend that you install the memory modules from the blue slots for better overclocking capability.
- Always install DIMMs with the same CAS latency. For optimal compatibility, we recommend that you install memory modules of the same version or date code (D/C) from the same vendor. Check with the retailer to get the correct memory modules.
- Due to the memory address limitation on 32-bit Windows® OS, when you install 4GB or more memory on the motherboard, the actual usable memory for the OS can be about 3GB or less. For effective use of memory, we recommend that you do any of the following:
  - Install a maximum of 3GB system memory if you are using a 32-bit Windows® OS.
  - Use a 64-bit Windows® OS if you want to install 4GB or more memory on the motherboard.
- This motherboard does not support DIMMs made up of 512Mb (64MB) chips or less (Memory chip capacity counts in Megabit, 8 Megabit/Mb = 1 Megabyte/MB).
- The maximum 64GB memory capacity can be supported with 16GB or above DIMMs. ASUS will update the memory QVL once the DIMMs are available in the market.



- The default memory operation frequency is dependent on its Serial Presence Detect (SPD), which is the standard way of accessing information from a memory module. Under the default state, some memory modules for overclocking may operate at a lower frequency than the vendor-marked value. To operate at the vendor-marked or at a higher frequency, refer to section 3.4 **Ai Tweaker menu** for manual memory frequency adjustment.
- For system stability, use a more efficient memory cooling system to support a full memory load (4 DIMMs) or overclocking condition.
- Visit the ASUS website at [www.asus.com](http://www.asus.com) for the latest QVL.

## F2A85-M PRO Motherboard Qualified Vendors Lists (QVL)

### DDR3 2400(O.C.) MHz capability

Vendors	Part No.	Size	SS/DS	Chip Brand	Chip NO.	Timing	Voltage	DIMM socket support (Optional)		
								1 DIMM	2 DIMMs	4 DIMMs
G.SKILL	F3-19200CL9D-4GBPI5(XMP)	4GB (2x 2GB)	DS	-	-	9-11-9-28	1.65V	*	*	*
KINGMAX	FLLE88F-C8KKAA HAI5(XMP)	2GB	SS	-	-	10-11-10-30	1.8V	*	*	*
Team	TXD34096M2400HC9N-L	4GB	DS	SEC 128 HCH9	K4B2G0846D	9-11-11-28	1.65V	*	*	*
Team	TXD34096M2400HC9N-L	4GB	DS	SEC 128 HCH9	K4B2G0846D	9-11-11-28	1.65V	*	*	*

### DDR3 2250(O.C.) MHz capability

Vendors	Part No.	Size	SS/DS	Chip Brand	Chip NO.	Timing	Voltage	DIMM socket support (Optional)		
								1 DIMM	2 DIMMs	4 DIMMs
KINGSTON	KHX2250C9D3T1K2/4GX(XMP)	4GB (2x2GB)	DS	-	-	-	1.85V	*	*	*

### DDR3 2200(O.C.) MHz capability

Vendors	Part No.	Size	SS/DS	Chip Brand	Chip NO.	Timing	Voltage	DIMM socket support (Optional)		
								1 DIMM	2 DIMMs	4 DIMMs
G.SKILL	F3-19200CL9D-4GBPI5(XMP)	4GB (2x 2GB)	DS	-	-	9-11-9-28	1.65V	*	*	*
KINGMAX	FLLE88F-C8KKAA HAI5(XMP)	2GB	SS	-	-	10-11-10-30	1.8V	*	*	*
Team	TXD34096M2400HC9N-L	4GB	DS	SEC 128 HCH9	K4B2G0846D	9-11-11-28	1.65V	*	*	*
Team	TXD34096M2400HC9N-L	4GB	DS	SEC 128 HCH9	K4B2G0846D	9-11-11-28	1.65V	*	*	*

### DDR3 2133(O.C.) MHz capability

Vendors	Part No.	Size	SS/DS	Chip Brand	Chip NO.	Timing	Voltage	DIMM socket support (Optional)		
								1 DIMM	2 DIMMs	4 DIMMs
A-DATA	AX3U2133GC2 G9B-DG2(XMP)	2GB	SS	-	-	9-11-9-27	1.55~1.75V	*	*	*
CORSAIR	CMT16GX3M4X 2133C9(XMP 1.3)	16GB (4GB x4)	DS	-	-	9-11-10-27	1.50V	*	*	*
CORSAIR	CMT4GX3M2A2 133C9(XMP)	4GB (2x 2GB)	DS	-	-	9-10-9-24	1.65V	*	*	*
CORSAIR	CMT4GX3M2B 2133C9(XMP)	4GB (2x 2GB)	DS	-	-	9-10-9-27	1.50V	*	*	*
CORSAIR	CMT8GX3M2B 2133C9(XMP)	8GB (4GB x 2)	DS	-	-	9-11-9-27	1.50V	*	*	*
G.SKILL	F3-17000CL9Q-16GBZH(XMP 1.3)	16GB (4GB x4)	DS	-	-	9-11-10-28	1.65V	*	*	*
KINGSTON	KHX2133C11D3 T1K2/16GX(XMP)	16GB (8GB x 2)	DS	-	-	-	1.6V	*	*	*
KINGSTON	KHX2133C9AD3 T1K2/4GX(XMP)	4GB (2x 2GB)	DS	-	-	-	1.65V	*	*	*
KINGSTON	KHX2133C9AD3 X2K2/4GX(XMP)	4GB (2 x 2GB)	DS	-	-	9-11-9-27	1.65V	*	*	*
KINGSTON	KHX2133C9AD3 T1K4/8GX(XMP)	8GB (4 x 2GB)	DS	-	-	9-11-9-27	1.65V	*	*	*
KINGSTON	KHX2133C9AD3 T1FK4/8GX(XMP)	8GB (4x 2GB)	DS	-	-	-	1.65V	*	*	*
PATRIOT	PGD38G2133 C11K(XMP)	16GB (4GB x4)	DS	-	-	11-11-11-30	1.65V	*	*	*
Team	TXD34096M 2133HC9N-L	4GB	DS	SEC 128 HCH9	K4B2G 0846D	9-11-11-28	1.65V	*	*	*
KINGSTON	KHX21C11T1B K2/16X(XMP)	16GB (8GBx2)	DS	-	-	-	1.6V	*	*	*
KINGSTON	KHX21C11T1 BK2/8X(XMP)	8GB (4GBx2)	DS	-	-	-	1.6V	*	*	*
Team	TXD34096M 2133HC9N-L	4GB	DS	SEC 128 HCH9	K4B2G 0846D	9-11-11-28	1.65V	*	*	*

## DDR3 2000(O.C.) MHz capability

Vendors	Part No.	Size	SS/DS	Chip Brand	Chip NO.	Timing	Voltage	DIMM socket support (Optional)			
								1 DIMM	2 DIMMs	4 DIMMs	
Apacer	78 AAGD5 9KD(XMP)	6GB(3 x 2GB)	DS	-	-	9-9-9-27	1.65V	*	*	*	*
CORSAIR	CMZ4GX3M2A2000C10(XMP)	4GB(2 x 2GB)	SS	-	-	10-10-10-27	1.50V	*	*	*	*
CORSAIR	CMT6GX3M3A2000C8(XMP)	6GB(3 x 2GB)	DS	-	-	8-8-8-24	1.65V	*	*	*	*
G.SKILL	F3-16000CL9D-4GBFLS(XMP)	4GB(2 x 2GB)	DS	-	-	9-9-9-24	1.65V	*	*	*	*
G.SKILL	F3-16000CL9D-4GBTD(XMP)	4GB(2 x 2GB)	DS	-	-	9-9-9-27	1.65V	*	*	*	*
G.SKILL	F3-16000CL6T-6GBPIS(XMP)	6GB (3x 2GB)	DS	-	-	6-9-6-24	1.65V	*	*	*	*
GEIL	GUP34GB2000C9DC(XMP)	4GB(2 x 2GB)	DS	-	-	9-9-9-28	1.65V	*	*	*	*
KINGSTON	KHX2000C9AD3T1K2/4GX(XMP)	4GB (2x 2GB)	DS	-	-	-	1.65V	*	*	*	*
KINGSTON	KHX2000C9AD3W1K2/4GX(XMP)	4GB (2x 2GB)	DS	-	-	-	1.65V	*	*	*	*
KINGSTON	KHX2000C9AD3T1K2/4GX(XMP)	4GB(2 x 2GB)	DS	-	-	9	1.65V	*	*	*	*
KINGSTON	KHX2000C9AD3W1K3/6GX(XMP)	6GB (3x 2GB)	DS	-	-	-	1.65V	*	*	*	*
KINGSTON	KHX2000C9AD3T1K3/6GX(XMP)	6GB (3x 2GB)	DS	-	-	-	1.65V	*	*	*	*
Asint	SLA302G08-ML2HB(XMP)	4GB	DS	HYNIX	H5TO2G8 3BFR H9C	-	-	*	*	*	*

## DDR3 1866 MHz capability

Vendors	Part No.	Size	SS/DS	Chip Brand	Chip NO.	Timing	Voltage	DIMM socket support (Optional)			
								1 DIMM	2 DIMMs	4 DIMMs	
CORSAIR	CMT4GX3M2A1866C9(XMP)	4GB(2 x 2GB)	DS	-	-	9-9-9-24	1.65V	*	*	*	*
CORSAIR	CMT6GX3MA1866C9(XMP)	6GB(3 x 2GB)	DS	-	-	9-9-9-24	1.65V	*	*	*	*
CORSAIR	CMZ8GX3M2A1866C9(XMP)	8GB(2 x 4GB)	DS	-	-	9-10-9-27	1.50V	*	*	*	*
G.SKILL	F3-14900CL9Q-16GBZL(XMP1.3)	16GB(4GB x4)	DS	-	-	9-10-9-28	1.5V	*	*	*	*
G.SKILL	F3-14900CL10Q2-64GBZLD(XMP1.3)	64GB(8GBx 8)	DS	-	-	10-11-10-30	1.5V	*	*	*	*
G.SKILL	F3-14900CL9D-8GBXL(XMP)	8GB(2 x 4GB)	DS	-	-	9-10-9-28	1.5V	*	*	*	*
G.SKILL	F3-14900CL9Q-8GBXL(XMP)	8GB(2GBx4)	DS	-	-	9-9-9-24	1.6V	*	*	*	*
KINGSTON	KHX1866C9D3K4/16GX(XMP)	16GB(4GB x4)	DS	-	-	-	1.65V	*	*	*	*
KINGSTON	KHX1866C9D3T1K3/6GX(XMP)	6GB(3 x 2GB)	DS	-	-	-	1.65V	*	*	*	*
KINGSTON	KHX1866C11D3P1K2/8G	8GB(4GB x 2)	DS	-	-	-	1.5V	*	*	*	*
KINGSTON	KHX1866C9D3K2/8GX(XMP)	8GB(4GBx2)	DS	-	-	-	1.65V	*	*	*	*

## DDR3 1600 MHz capability

Vendors	Part No.	Size	SS/DS	Chip Brand	Chip NO.	Timing	Voltage	DIMM socket support (Optional)			
								1 DIMM	2 DIMMs	4 DIMMs	
A-DATA	AM2U16BC2P1	2GB	SS	A-DATA	3CCD-1509 A EL1126T	-	-	*	*	*	*
A-DATA	AX3U1600XB2G79-2X(XMP)	4GB(2x2GB)	DS	-	-	7-9-7-21	1.55V-1.75V	*	*	*	*
A-DATA	AM2U16BC4P2	4GB	DS	A-DATA	3CCD-1509 A EL1126T	-	-	*	*	*	*
A-DATA	AX3U1600GC4G9-2G(XMP)	8GB(2x4GB)	DS	-	-	9-9-9-24	1.55V-1.75V	*	*	*	*
A-DATA	AX3U1600XC4G79-2X(XMP)	8GB(2x4GB)	DS	-	-	7-9-7-21	1.55V-1.75V	*	*	*	*
CORSAIR	TR3X3G1600C8D(XMP)	3GB(3x1GB)	SS	-	-	8-8-8-24	1.65V	*	*	*	*
CORSAIR	CMD12GX3M6A1600C8(XMP)	12GB(6x2GB)	DS	-	-	8-8-8-24	1.65V	*	*	*	*
CORSAIR	CMZ32GX3M4X1600C10(XMP)	32GB(8GBx4)	DS	-	-	10-10-10-27	1.50V	*	*	*	*
CORSAIR	CMP4GX3M2A1600C8(XMP)	4GB(2x2GB)	DS	-	-	8-8-8-24	1.65V	*	*	*	*
CORSAIR	CMP4GX3M2A1600C9(XMP)	4GB(2x2GB)	DS	-	-	9-9-9-24	1.65V	*	*	*	*
CORSAIR	CMP4GX3M2C1600C7(XMP)	4GB(2x2GB)	DS	-	-	7-8-7-20	1.65V	*	*	*	*
CORSAIR	CMX4GX3M2A1600C9(XMP)	4GB(2x2GB)	DS	-	-	9-9-9-24	1.65V	*	*	*	*
CORSAIR	CMX4GX3M2A1600C9(XMP)	4GB(2x2GB)	DS	-	-	9-9-9-24	1.65V	*	*	*	*
CORSAIR	TR3X6G1600C8 G(XMP)	6GB(3x2GB)	DS	-	-	8-8-8-24	1.65V	*	*	*	*
CORSAIR	TR3X6G1600C8D G(XMP)	6GB(3x2GB)	DS	-	-	8-8-8-24	1.65V	*	*	*	*
CORSAIR	TR3X6G1600C9 G(XMP)	6GB(3x2GB)	DS	-	-	9-9-9-24	1.65V	*	*	*	*
CORSAIR	CMP8GX3M2A1600C9(XMP)	8GB(2x4GB)	DS	-	-	9-9-9-24	1.65V	*	*	*	*
CORSAIR	CMZ8GX3M2A1600C7(XMP)	8GB(2x4GB)	DS	-	-	7-8-7-20	1.50V	*	*	*	*
CORSAIR	CMX8GX3M4A1600C9(XMP)	8GB(4x2GB)	DS	-	-	9-9-9-24	1.65V	*	*	*	*
Crucial	BL25664BN1608.16FF(XMP)	6GB(3x2GB)	DS	-	-	-	-	*	*	*	*
G.SKILL	F3-12800CL9D-2GBNQ(XMP)	2GB(2x1GB)	SS	-	-	9-9-9-24	1.5V	*	*	*	*

(continued on the next page)

## DDR3 1600 MHz capability

Vendors	Part No.	Size	SS/ DS	Chip Brand	Chip NO.	Timing	Voltage	DIMM socket support (Optional)		
								1 DIMM	2 DIMMs	4 DIMMs
G.SKILL	F3-12800CL7D-4GBRH(XMP)	4GB(2x2GB)	SS	-	-	7-7-7-24	1.6V	*	*	*
G.SKILL	F3-12800CL7D-4GBECO(XMP)	4GB(2x2GB)	DS	-	-	7-7-8-24	XMP 1.35V	*	*	*
G.SKILL	F3-12800CL7D-4GBRM(XMP)	4GB(2x2GB)	DS	-	-	7-8-7-24	1.6V	*	*	*
G.SKILL	F3-12800CL8D-4GBRM(XMP)	4GB(2x2GB)	DS	-	-	8-8-8-24	1.60V	*	*	*
G.SKILL	F3-12800CL9D-4GBECO(XMP)	4GB(2x2GB)	DS	-	-	9-9-9-24	XMP 1.35V	*	*	*
G.SKILL	F3-12800CL9D-4GBRL(XMP)	4GB(2x2GB)	DS	-	-	9-9-9-24	1.5V	*	*	*
G.SKILL	F3-12800CL9T-6GBN(XMP)	6GB(3x2GB)	DS	-	-	9-9-9-24	1.5V~ 1.6V	*	*	*
G.SKILL	F3-12800CL7D-8GBRH(XMP)	8GB(2x4GB)	DS	-	-	7-8-7-24	1.6V	*	*	*
G.SKILL	F3-12800CL8D-8GBECO(XMP)	8GB(2x4GB)	DS	-	-	8-8-8-24	XMP 1.35V	*	*	*
G.SKILL	F3-12800CL9D-8GBRL(XMP)	8GB(2x4GB)	DS	-	-	9-9-9-24	1.5V	*	*	*
GEIL	GET316GB1600C9QC(XMP)	16GB(4x4GB)	DS	-	-	9-9-9-28	1.6V	*	*	*
GEIL	GV34GB1600C8DC(XMP)	2GB	DS	-	-	8-8-8-28	1.6V	*	*	*
HYNIX	HMT351U6CFR8C-PB	4GB	DS	HYNIX	H5TQ2G83 CFR PBC	-	-	*	*	*
KINGMAX	FLGD45F-BBMF7 MAEH(XMP)	1GB	SS	-	-	7	-	*	*	*
KINGMAX	FLGE85F-B8KJ9A FEIS(XMP)	2GB	DS	-	-	-	-	*	*	*
KINGMAX	FLGE85F-BBMF7 MEEH(XMP)	2GB	DS	-	-	7	-	*	*	*
KINGSTON	KHX1600C9D3P1K2/4G	4GB(2x2GB)	SS	-	-	-	1.5V	*	*	*
KINGSTON	KHX1600C9D3K3/12GX(XMP)	12GB(3x4GB)	DS	-	-	9-9-9-27	1.65V	*	*	*
KINGSTON	KHX1600C9D3T1BK3/ 12GX(XMP)	12GB(3x4GB)	DS	-	-	9-9-9-27	1.65V	*	*	*
KINGSTON	KHX1600C9D3K4/16GX(XMP)	16GB(4GBx4)	DS	-	-	-	1.65V	*	*	*
KINGSTON	KHX1600C9AD3/2G	2GB	DS	-	-	-	1.65V	*	*	*
KINGSTON	KVR1600D3N11/2G-ES	2GB	DS	KTC	D1288JPN DPLD9U	11-11- 11-28	1.35V- 1.5V	*	*	*
KINGSTON	KHX1600C7D3K2/4GX(XMP)	4GB(2x2GB)	DS	-	-	-	1.65V	*	*	*
KINGSTON	KHX1600C8D3K2/4GX(XMP)	4GB(2x2GB)	DS	-	-	8	1.65V	*	*	*
KINGSTON	KHX1600C8D3T1K2/ 4GX(XMP)	4GB(2x2GB)	DS	-	-	8	1.65V	*	*	*
KINGSTON	KHX1600C9D3K2/4GX(XMP)	4GB(2x2GB)	DS	-	-	9	1.65V	*	*	*
KINGSTON	KHX1600C9D3L2/4GX(XMP)	4GB(2x2GB)	DS	-	-	9	XMP 1.35V	*	*	*
KINGSTON	KHX1600C9D3X2K2/ 4GX(XMP)	4GB(2x2GB)	DS	-	-	9-9-9-27	1.65V	*	*	*
KINGSTON	KHX1600C9D3T1K3/ 6GX(XMP)	6GB(3x2GB)	DS	-	-	-	1.65V	*	*	*
KINGSTON	KHX1600C9D3K3/6GX(XMP)	6GB(3x2GB)	DS	-	-	9	1.65V	*	*	*
KINGSTON	KHX1600C9D3T1BK3/ 6GX(XMP)	6GB(3x2GB)	DS	-	-	9-9-9-27	1.65V	*	*	*
KINGSTON	KHX1600C9D3K2/8GX(XMP)	8GB(2x4GB)	DS	-	-	9-9-9-27	1.65V	*	*	*
KINGSTON	KHX1600C9D3P1K2/8G	8GB(2x4GB)	DS	-	-	-	1.5V	*	*	*
Super Talent	WA160UX8G9	6GB(3x2GB)	DS	-	-	9	-	*	*	*
Transcend	JM1600KLN-8GK	8GB(4GBx2)	DS	Transcend	TK483PCW3	-	-	*	*	*
SanMax	SMD-4G68HP-16KZ	4GB	DS	HYNIX	H5TQ2G83 BFR PBC	-	-	*	*	*
AMD	AE32G1609U1-U	2GB	SS	-	23EY4587M B6H11503M	9-9-9-24	1.5V	*	*	*
AMD	AE34G1609U2-U	4GB	DS	AMD	23EY4587M B6H11503M	9-9-9-24	1.5V	*	*	*
ASint	SLZ302G08-EGN1C	2GB	SS	ASint	SLZ302G 08-GN1C	-	-	*	*	*
ASint	SLZ3128M8-EGJ1D(XMP)	2GB	DS	ASint	3128M8-GJ1D	9-9-9-24	1.6V	*	*	*
ASint	SLA302G08-EGG1C(XMP)	4GB	DS	ASint	302G08-GG1C	-	-	*	*	*
ASint	SLA302G08-EGJ1C(XMP)	4GB	DS	ASint	302G08-GJ1C	-	-	*	*	*
ASint	SLA302G08-EGN1C	4GB	DS	ASint	SLA302G 08-GN1C	-	-	*	*	*
ASint	SLB304G08-EGN1B	8GB	DS	ASint	SLB304G 08-GN1B	-	-	*	*	*
Elixir	M2P2G64CB8HC9N-DG(XMP)	2GB	DS	-	-	-	-	*	*	*
Elixir	M2X8G64CB8HB5N-DG(XMP)	8GB	DS	Elixir 1213	N2CB4G8B OBN-DG	-	-	*	*	*
Mushkin	998659(XMP)	6GB(3x2GB)	DS	-	-	9-9-9-24	-	*	*	*
Mushkin	998659(XMP)	6GB(3x2GB)	DS	-	-	9-9-9-24	1.5~ 1.6V	*	*	*
PATRIOT	PGD316G1600ELK(XMP)	32GB(8GBx4)	DS	-	-	9-9-9-24	1.65V	*	*	*
PATRIOT	PGS34G1600LLKA	4GB(2x2GB)	DS	-	-	7-7-7-20	1.7V	*	*	*
Silicon Power	SP002GBLTU160V02(XMP)	2GB	SS	S-POWER	20YT5NG-1201	-	-	*	*	*
Silicon Power	SP004GBLTU160V02(XMP)	4GB	DS	S-POWER	20YT5NG-1201	-	-	*	*	*
Apacer	78.B1GE3.9L10C	4GB	DS	Apacer KZCC	AM5D5908 DEQ5CK	-	-	*	*	*
KINGSTON	KHX16C9K2/16	16GB(8GBx2)	DS	-	-	-	1.5V	*	*	*
Elixir	M2X8G64CB8HB5N-DG(XMP)	8GB	DS	Elixir 1213	N2CB4G8 BOBN-DG	-	-	*	*	*



## DDR3 1333 MHz capability

Vendors	Part No.	Size	SS/DS	Chip Brand	Chip NO.	Timing	Voltage	DIMM socket support (Optional)		
								1 DIMM	2 DIMMs	4 DIMMs
A-DATA	AD31333001GOU	1GB	SS	A-Data	AD30908C8D-151C E0906	-	-	*	*	*
A-DATA	AD3U1333C2G9	2GB	SS	A-DATA	3CCD-1509HNA1126L	-	-	*	*	*
A-DATA	AM2U139C2P1	2GB	SS	ADATA	3CCD-1509A EL1127T	-	-	*	*	*
A-DATA	AX3U1333C2G9-BP	2GB	SS	-	-	-	-	*	*	*
A-DATA	AD31333G001GOU	3GB(3 x 1GB)	SS	-	-	8-8-8-24	1.65-1.85V	*	*	*
A-DATA	AXDU1333G2C69-2G(XMP)	4GB(2 x 2GB)	SS	-	-	9-9-9-24	1.25V 1.35V(low voltage)	*	*	*
A-DATA	AD31333G002GMU	2GB	DS	-	-	8-8-8-24	1.65-1.85V	*	*	*
A-DATA	AD631C1624EV	4GB	DS	A-Data	3CCA-1509A	-	-	*	*	*
A-DATA	AM2U139C4P2	4GB	DS	ADATA	3CCD-1509A EL1127T	-	-	*	*	*
A-DATA	SU3U1333W8G9-B	8GB	DS	ELPIDA	J4208BASE-DJ-F	-	-	*	*	*
Apacer	78.A1GC6.9L1	2GB	DS	Apacer	AM5D5808DEWSBG	-	-	*	*	*
Apacer	78.A1GC6.9L1	2GB	DS	Apacer	AM5D5808FEQSBG	9	-	*	*	*
Apacer	AU02GF433C9NBGC	2GB	DS	Apacer	AM5D5808APQSBG	-	-	*	*	*
Apacer	78.B1GDE.9L10C	4GB	DS	Apacer	AM5D5908CEHSBG	-	-	*	*	*
CORSAIR	TR3X3G1333C9 G	3GB(3 x 1GB)	SS	-	-	9-9-9-24	1.50V	*	*	*
CORSAIR	TR3X6G1333C9 G	6GB(3x 2GB)	SS	-	-	9-9-9-24	1.50V	*	*	*
CORSAIR	CMD24GX3M6A1333C9(XMP)	24GB(6 x 4GB)	DS	-	-	9-9-9-24	1.60V	*	*	*
CORSAIR	TW3X4G1333C9D G	4GB(2 x 2GB)	DS	-	-	9-9-9-24	1.50V	*	*	*
CORSAIR	CM3X4GA1333C9N2	4GB	DS	CORSAIR	256MBDCJGE LC0401136	9-9-9-24	-	*	*	*
CORSAIR	CMX4GX3M1A1333C9	4GB	DS	-	-	9-9-9-24	1.50V	*	*	*
CORSAIR	CMD8GX3M4A1333C7	8GB(4 x 2GB)	DS	-	-	7-7-7-20	1.60V	*	*	*
Crucial	CT12864BA1339.8FF	1GB	SS	Micron	9FF22D9KPT	9	-	*	*	*
Crucial	CT25664BA1339.16FF	2GB	DS	Micron	9KF27D9KPT	9	-	*	*	*
Crucial	BL25664BN1337.16FF (XMP)	6GB(3 x 2GB)	DS	-	-	7-7-7-24	1.65V	*	*	*
ELPIDA	EBJ10UE8EDF0-DJ-F	1GB	SS	ELPIDA	J1108EDSE-DJ-F	-	1.35V(low voltage)	*	*	*
ELPIDA	EBJ21UE8EDF0-DJ-F	2GB	DS	ELPIDA	J1108EDSE-DJ-F	-	1.35V(low voltage)	*	*	*
G.SKILL	F3-10600CL8D-2GBHK(XMP)	1GB	SS	G.SKILL	-	-	-	*	*	*
G.SKILL	F3-10600CL9D-2GBNQ	2GB(2 x 1GB)	SS	-	-	9-9-9-24	1.5V	*	*	*
G.SKILL	F3-10666CL8D-4GBECO(XMP)	4GB(2 x 2GB)	DS	-	-	8-8-8-8-24	XMP 1.35V	*	*	*
G.SKILL	F3-10666CL7D-8GBRH(XMP)	8GB(2 x 4GB)	DS	-	-	7-7-7-21	1.5V	*	*	*
GEIL	GV32GB1333C9DC	2GB(2 x 1GB)	DS	-	-	9-9-9-24	1.5V	*	*	*
GEIL	GG34GB1333C9DC	4GB(2 x 2GB)	DS	GEIL	GL1L128M88BA12N	9-9-9-24	1.3V(low voltage)	*	*	*
GEIL	GV34GB1333C9DC	4GB(2 x 2GB)	DS	-	-	9-9-9-24	1.5V	*	*	*
GEIL	GVP34GB1333C7DC	4GB(2 x 2GB)	DS	-	-	7-7-7-24	1.5V	*	*	*
Hynix	HMT112U6TFR8A-H9	1GB	SS	Hynix	H5TC1G83TFRH9A	-	1.35V(low voltage)	*	*	*
Hynix	HMT325U6BFR8C-H9	2GB	SS	Hynix	H5TQ2G83BFRH9C	-	1.35V(low voltage)	*	*	*
Hynix	HMT125U6TFR8A-H9	2GB	DS	Hynix	H5TC1G83TFRH9A	-	1.35V(low voltage)	*	*	*
Hynix	HMT351U6BFR8C-H9	4GB	DS	Hynix	H5TQ2G83BFRH9C	-	1.35V(low voltage)	*	*	*
KINGMAX	FLFD45F-B8KL9 NAES	1GB	SS	KINGMAX	KKB8BFNWBFGNX-27A	-	-	*	*	*
KINGMAX	FLFE85F-C8KF9 CAES	2GB	SS	KINGMAX	KFC8BFMFXF-DXX-15A	-	-	*	*	*
KINGMAX	FLFE85F-C8KL9 NAES	2GB	SS	KINGMAX	KFC8FNLXF-DXX-15A	-	-	*	*	*
KINGMAX	FLFE85F-C8KM9 NAES	2GB	SS	KINGMAX	KFC8FNMXF-BXX-15A	-	-	*	*	*
KINGMAX	FLFE85F-B8KL9 NEES	2GB	DS	KINGMAX	KKB8BFNWBFGNX-26A	-	-	*	*	*
KINGMAX	FLFF65F-C8KL9 NEES	4GB	DS	KINGMAX	KFC8FNLXF-DXX-15A	-	-	*	*	*
KINGMAX	FLFF65F-C8KM9 NEES	4GB	DS	KINGMAX	KFC8FNMXF-BXX-15A	-	-	*	*	*
KINGSTON	KVR1333D3N9/1G(Low profile)	1GB	SS	ELPIDA	J1108DBG-DJ-F	9	1.5V	*	*	*
KINGSTON	KVR1333D3N9/2G(Low profile)	2GB	SS	Hynix	H5TQ2G83AFRH9C	9	-	*	*	*
KINGSTON	KVR1333D3S8N9/2G	2GB	SS	Micron	1ID77 D9LGK	-	1.5V	*	*	*
KINGSTON	KVR1333D3S8N9/2G-SP(Low profile)	2GB	SS	ELPIDA	J2108BCSE-DJ-F	-	1.5V	*	*	*
KINGSTON	KVR1333D3N9/2G(Low profile)	2GB	DS	ELPIDA	J1108BFBG-DJ-F	9	1.5V	*	*	*
KINGSTON	KVR1333D3N9/2G	2GB	DS	KTC	D1288JPNPLD9U	9	1.5V	*	*	*

(continued on the next page)

# DDR3 1333 MHz capability

Vendors	Part No.	Size	SS/DS	Chip Brand	Chip NO.	Timing	Voltage	DIMM socket support (Optional)		
								1 DIMM	2 DIMMs	4 DIMMs
KINGSTON	KVR1333D3N9/2G	2GB	DS	ELPIDA	J1108BDSSE-DJ-F	9	1.5V	*	*	*
KINGSTON	KVR1333D3N9/2G-SP(Low profile)	2GB	DS	KTC	D1288JEMFNGD9U	-	1.5V	*	*	*
KINGSTON	KVR1333D3N9/2G-SP(low profile)	2GB	DS	KINGSTON	D1288JPSFPGD9U	-	1.5V	*	*	*
KINGSTON	KHX1333C7D3K2/4GX(XMP)	4GB(2 x 2GB)	DS	-	-	7	1.65V	*	*	*
KINGSTON	KHX1333C9D3UK2/4GX(XMP)	4GB(2 x 2GB)	DS	-	-	9	XMP 1.25V	*	*	*
KINGSTON	KVR1333D3N9/4G(Low profile)	4GB	DS	ELPIDA	J2108BCSE-DJ-F	9	1.5V	*	*	*
KINGSTON	KVR1333D3N9/4G(Low profile)	4GB	DS	ELPIDA	J2108BCSE-DJ-F	-	1.5V	*	*	*
KINGSTON	KVR1333D3N9/4G	4GB	DS	KTC	D2568JENCNGD9U	-	1.5V	*	*	*
KINGSTON	KVR1333D3N9/4G	4GB	DS	Hynix	H5TQ2G83AFR	-	-	*	*	*
KINGSTON	KVR1333D3N9/4G-SP(Low profile)	4GB	DS	KINGSTON	D2568JENCPGD9U	-	1.5V	*	*	*
Micron	MT4JTF12864AZ-1G4D1	1GB	SS	Micron	QJD12D9LQG	-	-	*	*	*
Micron	MT8JTF12864AZ-1G4F1	1GB	SS	Micron	9FF22D9KPT	9	-	*	*	*
Micron	MT8JTF25664AZ-1G4D1	2GB	SS	Micron	QJD12D9LKG	-	-	*	*	*
Micron	MT8JTF25664AZ-1G4M1	2GB	SS	MICRON	UJM22 D9PFL	-	-	*	*	*
Micron	MT16JTF25664AZ-1G4F1	2GB	DS	Micron	9KF27D9KPT	9	-	*	*	*
Micron	MT16JTF51264AZ-1G4D1	4GB	DS	Micron	OLD22D9LKG	-	-	*	*	*
NANYA	NT4GC648HG0NF-CG	4GB	DS	NANYA	NT5CB256M8GN-CG	-	-	*	*	*
PSC	AL7F8G73F-DJ2	1GB	SS	PSC	A3P1GF3FGF	-	-	*	*	*
PSC	AL8F8G73F-DJ2	2GB	DS	PSC	A3P1GF3FGF	-	-	*	*	*
SAMSUNG	M378B2873FH5-CH9	1GB	SS	SAMSUNG	K4B1G0846F	-	-	*	*	*
SAMSUNG	M378B5773DHO-CH9	2GB	SS	SAMSUNG	K4B2G0846D	-	-	*	*	*
SAMSUNG	M378B5673FHO-CH9	2GB	DS	SAMSUNG	K4B1G0846F	-	-	*	*	*
SAMSUNG	M378B5273CHO-CH9	4GB	DS	SAMSUNG	K4B2G0846C	-	-	*	*	*
Super Talent	W1333UA1GH	1GB	SS	Hynix	H5TQ1G83TFR	9	-	*	*	*
Super Talent	W1333UX2G8(XMP)	2GB(2x 1GB)	SS	-	-	8	-	*	*	*
Super Talent	W1333UB2GS	2GB	DS	SAMSUNG	K4B1G0846F	9	-	*	*	*
Super Talent	W1333UB4GS	4GB	DS	SAMSUNG	K4B2G0846C	-	-	*	*	*
Super Talent	W1333UX6GM	6GB(3x 2GB)	DS	Micron	0BF27D9KPT	9-9-9-24	1.5V	*	*	*
Transcend	JM1333KLN-2G	2GB	SS	Hynix	H5TQ2G83BZRH9C	-	-	*	*	*
Transcend	TS256MLK64V3U	2GB	DS	Micron	9GF27D9KPT	-	-	*	*	*
Transcend	TS1GLK64V3H	8GB	DS	Micron	IVD22D9PBC	-	-	*	*	*
KINGSTEK	KSTD3PC-10600	2GB	SS	MICRON	PE911-125E	-	-	*	*	*
AMD	AE32G1339U1-U	2GB	SS	AMD	23EY4587MB3H11503M	9-9-9-24	1.5V	*	*	*
AMD	AE34G1339U2-U	4GB	DS	AMD	23EY4587MB3H11503M	9-9-9-24	1.5V	*	*	*
ASint	SL2302G08-EDJ1C	2GB	SS	Asint	SL2302G08-DJ1C	-	-	*	*	*
ASint	SLA302G08-EDJ1C	4GB	DS	Asint	SLA302G08-DJ1C	-	-	*	*	*
ASint	SLB304G08-EDJ1B	8GB	DS	Asint	SLB304G08-DJ1B	-	-	*	*	*
Elixir	M2F2G64CB88B7N-CG	2GB	SS	Elixir	N2CB2G80BN-CG	-	-	*	*	*
Elixir	M2F2G64CB88D7N-CG	2GB	SS	Elixir	N2CB2G80DN-CG	-	-	*	*	*
Elixir	M2F2G64CB88G7N-CG	2GB	SS	Elixir	N2CB2G80GN-CG	-	-	*	*	*
Elixir	M2F4G64CB8H5N-CG	4GB	DS	Elixir	N2CB2G80BN-CG	-	-	*	*	*
Elixir	M2F4G64CB8H5N-CG	4GB	DS	Elixir	N2CB2G80DN-CG	-	-	*	*	*
KINGSHARE	KSRPCD313332G	2GB	DS	PATRIOT	PM128M8D385-15	-	-	*	*	*
Kingtiger	2GB DIMM PC3-10666	2GB	DS	SAMSUNG	SEC 904 HCH9 K4B1G0846D	-	-	*	*	*
Kingtiger	KTG2G1333PG3	2GB	DS	-	-	-	-	*	*	*
MARKVISION	BMD32048M1333C9-1123	2GB	DS	MARKVISION	M3D1288P-13	-	-	*	*	*
MARKVISION	BMD34096M1333C9-1124	4GB	DS	MARKVISION	M3D2568E-13	-	-	*	*	*
PATRIOT	PSD32G13332H	2GB	DS	-	-	-	-	*	*	*
PATRIOT	PG38G1333EL(XMP)	8GB	DS	-	-	9-9-9-24	1.5V	*	*	*
RAMAXEL	RMR1870E4D8E8F-1333	2GB	DS	ELPIDA	J1108BDBG-DJ-F	-	-	*	*	*
RAMAXEL	RMR1870EC58E9F-1333	4GB	DS	ELPIDA	J2108BCSE-DJ-F	-	-	*	*	*
RIDATA	C304627CB1AG22Fe	2GB	DS	RIDATA	N/A	9	-	*	*	*
RIDATA	E304459CB1AG32Cf	4GB	DS	RIDATA	N/A	9	-	*	*	*
Silicon Power	SP002GBLTU133V02	2GB	SS	S-POWER	20YT3NG-1202	-	-	*	*	*
SILICON POWER	SP002GBLTU133S02	2GB	DS	Elixir	N2CB1680AN-C6	9	-	*	*	*
Silicon Power	SP004GBLTU133V02	4GB	DS	S-POWER	20YT3NG-1201	-	-	*	*	*
TAKEMS	TMS2GB364D081-107EY	2GB	DS	-	-	7-7-7-20	1.5V	*	*	*
TAKEMS	TMS2GB364D082-138EW	2GB	DS	-	-	8-8-8-24	1.5V	*	*	*
UMAX	E41302GP0-73BDB	2GB	DS	UMAX	U2S24D30TP-13	-	-	*	*	*
WINTEC	3WVS1333-2G-CNR	2GB	DS	AMPO	AM3420803-13H	-	-	*	*	*

## DDR3 1066 MHz capability

Vendors	Part No.	Size	SS/ DS	Chip Brand	Chip NO.	Timing	Voltage	DIMM socket support (Optional)		
								1 DIMM	2 DIMMs	4 DIMMs
Crucial	CT12864BA1067.8FF	1GB	SS	Micron	9GF22D9KPT	7	-	*	*	*
Crucial	CT25664BA1067.16FF	2GB	DS	Micron	9HF22D9KPT	7	-	*	*	*
ELPIDA	EBJ10UE8EDFG-AE-F	1GB	SS	ELPIDA	J1108EDSE-DJ-F	-	1.35V(low voltage)	*	*	*
ELPIDA	EBJ21UE8EDFG-AE-F	2GB	DS	ELPIDA	J1108EDSE-DJ-F	-	1.35V(low voltage)	*	*	*
KINGSTON	KVR1066D3N7/1G(Low profile)	1GB	SS	ELPIDA	J1108BFSE-DJ-F	7	1.5V	*	*	*
KINGSTON	KVR1066D3N7/2G	2GB	DS	ELPIDA	J1108BDSE-DJ-F	7	1.5V	*	*	*
KINGSTON	KVR1066D3N7/4G	4GB	DS	Hynix	H5TQ2G83AFR	7	1.5V	*	*	*



Side(s): SS - Single-sided DS - Double-sided DIMM support:

- (1) Supports one (1) module inserted into any slot as Single-channel memory configuration. We suggest that you install the module into A2 slot.
- (2) Supports two (2) modules inserted into either the blue slots or the black slots as one pair of Dual-channel memory configuration. We suggest that you install the modules into slots A2 and B2 for better compatibility.
- (4) Supports four (4) modules inserted into both the blue and black slots as two pairs of Dual-channel memory configuration.



- When overclocking, some AMD CPU models may not support DDR3 1600 or higher frequency DIMMS.
- Visit the ASUS website for the latest QVL.

## 1.2.4 Expansion slots



Unplug the power cord before adding or removing expansion cards. Failure to do so may cause you physical injury and damage motherboard components.

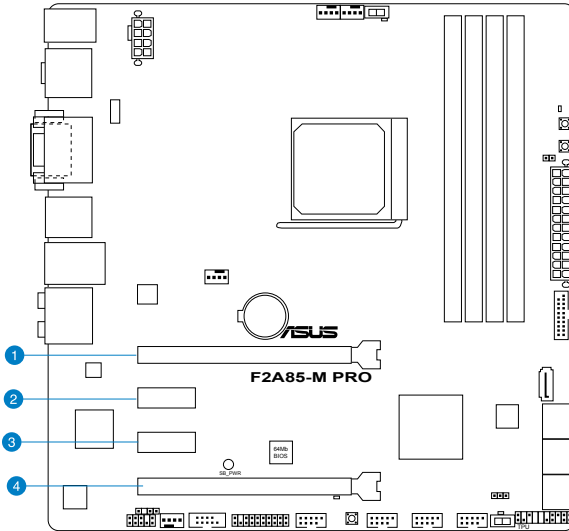

Slot No.	Slot Description
1	PCIe 2.0 x16_1 slot (Single @x16 or dual@x8x8 mode)
2	PCIe 2.0 x1_1 slot
3	PCIe 2.0 x1_2 slot
4	PCIe 2.0 x16_2 slot (Single @x16 or dual@x8x8 mode)

VGA configuration	PCI Express operating mode	
	PCIe 2.0 x16_1	PCIe 2.0 x16_2
Single VGA/PCIe card	x16 (Recommend for single VGA)	N/A
Dual VGA/PCIe card	x8	x8



- In single VGA card mode, use the PCIe 2.0 x16\_1 slot (navy blue) for a PCI Express x16 graphics card to get better performance.
- We recommend that you provide sufficient power when running CrossFireX™ mode.
- Connect a chassis fan to the motherboard connector labeled CHA\_FAN1/2/3 when using multiple graphics cards for better thermal environment.

## IRQ assignments for this motherboard

	A	B	C	D	E	F	G	H
PCIe x16_1	-	-	shared	-	-	-	-	-
PCIe x16_2	-	-	-	shared	-	-	-	-
PCIe x1_1	shared	-	-	-	-	-	-	-
PCIe x1_2	-	-	-	shared	-	-	-	-
ASM USB3	-	shared	-	-	-	-	-	-
USB 3.0_1	-	-	shared	-	-	-	-	-
USB 3.0_2	-	shared	-	-	-	-	-	-
Realtek 8111F (LAN)	-	-	shared	-	-	-	-	-
On Chip SATA	-	-	-	shared	-	-	-	-
On Chip USB_1	-	-	shared	-	-	-	-	-
On Chip USB_2	-	-	shared	-	-	-	-	-
On Chip USB_3	-	-	shared	-	-	-	-	-
On Chip USB_4	-	-	shared	-	-	-	-	-
On Chip USB_5	-	-	shared	-	-	-	-	-
HD Audio	shared	-	-	-	-	-	-	-

## 1.2.5 Onboard switches and buttons

Onboard switches and buttons allow you to fine-tune performance when working on a bare or open-case system. This is ideal for overclockers and gamers who continually change settings to enhance system performance.

### 1. DirectKey button

This feature allows your system to go to the BIOS Setup program with the press of a button. With DirectKey, you can enter the BIOS anytime without having to press the <Delete> key during POST. It allows you to turn on or turn off the system and conveniently enter the BIOS during bootup.

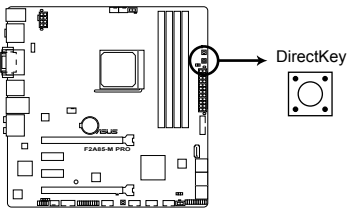

**F2A85-M PRO DirectKey button**



---

Ensure to save your data before using the DirectKey button.

---



- When the system is on and you press the DirectKey button, your system will shut down. Press the DirectKey button again or the Power-on button to reboot and enter the BIOS directly.
  - Turn off your system using the power-on button to allow your system to go through POST (without entering the BIOS) when you reboot your system.
  - Refer to **Chapter 3.7 Boot Menu** for details about setting the DirectKey default function.
-

## 2. MemOK! switch

Installing DIMMs that are incompatible with the motherboard may cause system boot failure, and the DRAM\_LED near the MemOK! switch lights continuously. Press and hold the MemOK! switch until the DRAM\_LED starts blinking to begin automatic memory compatibility tuning for successful boot.

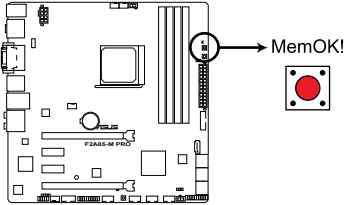

**F2A85-M PRO MemOK! switch**



- Refer to section 1.2.7 **Onboard LEDs** for the exact location of the DRAM\_LED.
- The DRAM\_LED also lights when the DIMM is not properly installed. Turn off the system and reinstall the DIMM before using the MemOK! function.
- The MemOK! switch does not function under Windows® OS environment.
- During the tuning process, the system loads and tests failsafe memory settings. It takes about 30 seconds for the system to test one set of failsafe settings. If the test fails, the system reboots and test the next set of failsafe settings. The blinking speed of the DRAM\_LED increases, indicating different test processes.
- Due to memory tuning requirement, the system automatically reboots when each timing set is tested. If the installed DIMMs still fail to boot after the whole tuning process, the DRAM\_LED lights continuously. Replace the DIMMs with ones recommended in the Memory QVL (Qualified Vendors Lists) in this user manual or on the ASUS website at [www.asus.com](http://www.asus.com).
- If you turn off the computer and replace DIMMs during the tuning process, the system continues memory tuning after turning on the computer. To stop memory tuning, turn off the computer and unplug the power cord for about 5–10 seconds.
- If your system fail to boot due to BIOS overclocking, press the MemOK! switch to boot and load BIOS default settings. A message will appear during POST reminding you that the BIOS has been restored to its default settings.
- We recommend that you download and update to the latest BIOS version from the ASUS website at [www.asus.com](http://www.asus.com) after using the MemOK! function.

### 3. TPU switch

This switch allows you to enable or disable the TPU function.

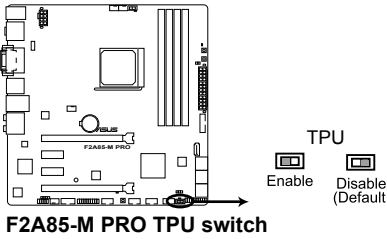

### 4. EPU switch

This switch allows you to enable or disable the EPU function.

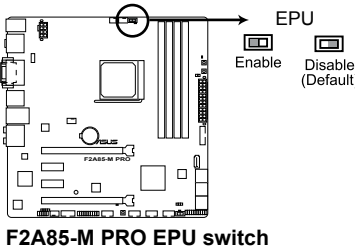

### 5. BIOS Flashback button

USB BIOS Flashback allows you to easily update the BIOS without entering the BIOS or operating system. Just connect the USB storage device containing the BIOS file to the USB port, press the BIOS Flashback button, and the BIOS is updated automatically.

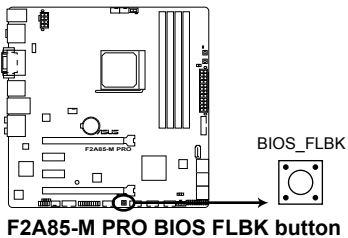

---

For more details about using the USB BIOS Flashback button, refer to section **2.2.1 USB BIOS Flashback**.

---



## 1.2.6 Jumpers

### Clear RTC RAM (CLRRTC)

This jumper allows you to clear the Real Time Clock (RTC) RAM in CMOS. You can clear the CMOS memory of date, time, and system setup parameters by erasing the CMOS RTC RAM data. The onboard button cell battery powers the RAM data in CMOS, which include system setup information such as system passwords.

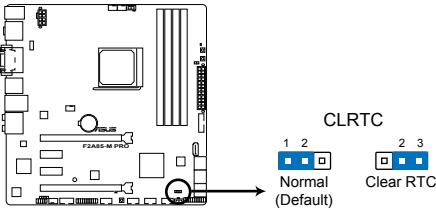

### F2A85-M PRO Clear RTC RAM

To erase the RTC RAM:

1. Turn OFF the computer and unplug the power cord.
2. Move the jumper cap from pins 1-2 (default) to pins 2-3. Keep the cap on pins 2-3 for about 5~10 seconds, then move the cap back to pins 1-2.
3. Plug the power cord and turn ON the computer.
4. Hold down the **<Del>** key during the boot process and enter BIOS setup to reenter data.



---

Except when clearing the RTC RAM, never remove the cap on CLRRTC jumper default position. Removing the cap will cause system boot failure!

---



- If the steps above do not help, remove the onboard battery and move the jumper again to clear the CMOS RTC RAM data. After clearing the CMOS, reinstall the battery.
  - You do not need to clear the RTC when the system hangs due to overclocking. For system failure due to overclocking, use the CPU Parameter Recall (C.P.R) feature. Shut down and reboot the system so the BIOS can automatically reset parameter settings to default values.
-

## 1.2.7 Onboard LEDs

### 1. Standby Power LED

The motherboard comes with a standby power LED that lights up to indicate that the system is ON, in sleep mode, or in soft-off mode. This is a reminder that you should shut down the system and unplug the power cable before removing or plugging in any motherboard component. The illustration below shows the location of the onboard LED.

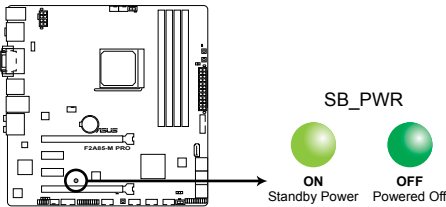

**F2A85-M PRO Onboard LED**

### 2. DRAM LED

DRAM LED checks the DRAM in sequence during motherboard booting process. If an error is found, the LED next to the error device will continue lighting until the problem is solved. This user-friendly design provides an intuitive way to locate the root problem within a second.

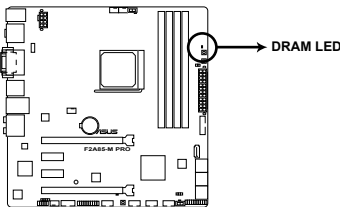

**F2A85-M PRO DRAM LED**

### 3. TPU LED

The TPU LED lights when the TPU switch is turned to **Enable**.

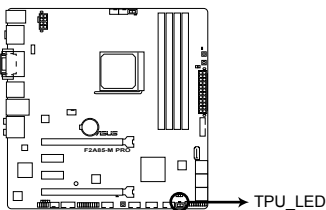

**F2A85-M PRO TPU Boost LED**

#### 4. EPU LED

The EPU LED lights when the EPU switch is turned to **Enable**.

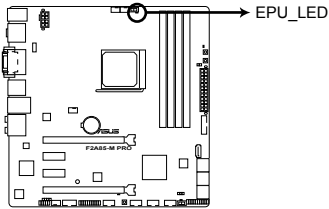

**F2A85-M PRO EPU Boost LED**

#### 5. BIOS Flashback LED (FLBK\_LED)

The FLBK LED lights when the USB Flashback button is pressed for three seconds.

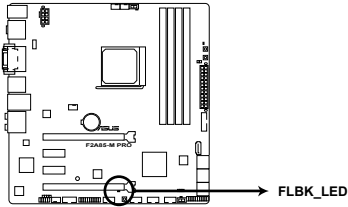

**F2A85-M PRO FLBK LED**

## 1.2.8 Internal connectors

### 1. CPU and chassis fan connectors (4-pin CPU\_FAN, and 4-pin CHA\_FAN1/2/3)

Connect the fan cables to the fan connectors on the motherboard, ensuring that the black wire of each cable matches the ground pin of the connector.

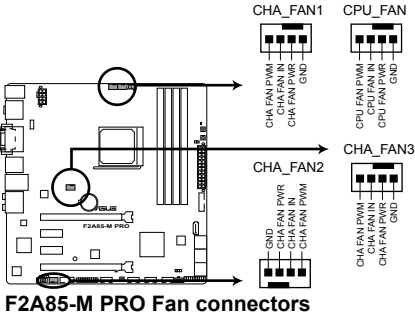

DO NOT forget to connect the fan cables to the fan connectors. Insufficient air flow inside the system may damage the motherboard components. These are not jumpers! DO NOT place jumper caps on the fan connectors.



- The CPU\_FAN connector supports a CPU fan of maximum 2A (24 W) fan power.
- Only the CPU\_FAN and CHA\_FAN1/2/3 connectors support the ASUS Fan Xpert 2 feature.
- If you install two VGA cards, we recommend that you plug the rear chassis fan cable to the motherboard connector labeled CHA\_FAN1/2 for better thermal environment.

## 2. ATX power connectors (24-pin EATXPWR, 8-pin EATX12V)

These connectors are for an ATX power supply. The plugs from the power supply are designed to fit these connectors in only one orientation. Find the proper orientation and push down firmly until the connectors completely fit.

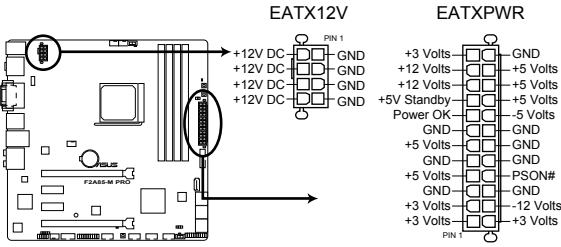

**F2A85-M PRO ATX power connectors**



- We recommend that you use an ATX 12V Specification 2.0-compliant power supply unit (PSU) with a minimum of 300W power rating. This PSU type has 24-pin and 4-pin power plugs.
- If you intend to use a PSU with 20-pin and 4-pin power plugs, ensure that the 20-pin power plug can provide at least 15 A on +12 V and that the PSU has a minimum power rating of 300W. The system may become unstable or may not boot up if the power is inadequate.
- DO NOT forget to connect the 4-pin / 8-pin ATX +12V power plug. Otherwise, the system will not boot up.
- We recommend that you use a PSU with higher power output when configuring a system with more power-consuming devices or when you intend to install additional devices. The system may become unstable or may not boot up if the power is inadequate.
- If you are uncertain about the minimum power supply requirement for your system, refer to the Recommended Power Supply Wattage Calculator at <http://support.asus.com/PowerSupplyCalculator/PSCalculator.aspx?SLanguage=en-us> for details.

### 3. Serial ATA 6.0 Gb/s connectors (7-pin SATA6G 1~7)

These connectors are for the Serial ATA 6.0 Gb/s signal cables for Serial ATA hard disk drives and optical disc drives. If you installed Serial ATA hard disk drives, you can create a RAID 0, RAID 1, RAID 5, RAID 10, or JBOD configuration through the onboard controller.

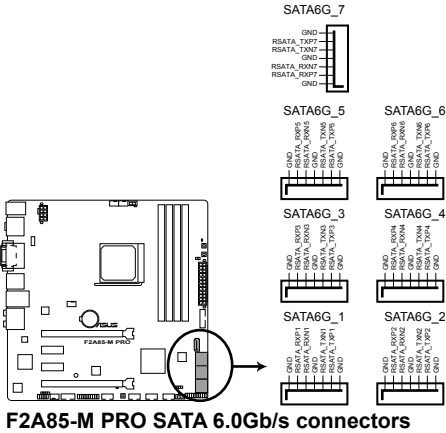

F2A85-M PRO SATA 6.0Gb/s connectors



- These connectors are set to **AHCI** mode by default. In AHCI mode, you can connect Serial ATA boot/data hard disk drives to these connectors. If you intend to create a Serial ATA RAID set using these connectors, set the type of the SATA connectors in the BIOS to **[RAID]**. See section **3.5.2 SATA Configuration** for details.
- You must install Windows® XP Service Pack 3 or later version before using Serial ATA hard disk drives. The Serial ATA RAID feature is available only if you are using Windows® XP SP3 or later version.
- When using hot-plug and NCQ, set the type of the SATA connectors in the BIOS to **[AHCI]**. See section **3.5.2 SATA Configuration** for details.

#### 4. Serial port connector (10-1 pin COM1)

This connector is for a serial (COM) port. Connect the serial port module cable to this connector, then install the module to a slot opening at the back of the system chassis.

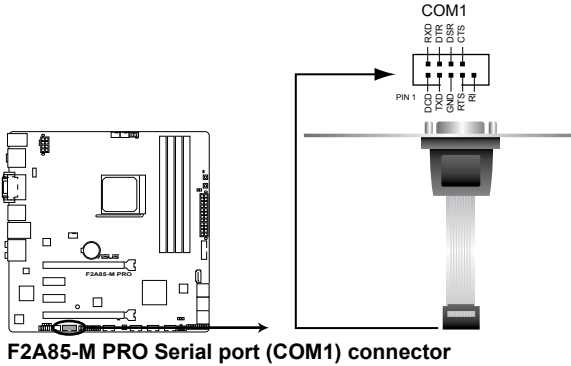

The COM module is purchased separately.

#### 5. Digital audio connector (4-1 pin SPDIF\_OUT)

This connector is for an additional Sony/Philips Digital Interface (S/PDIF) port.

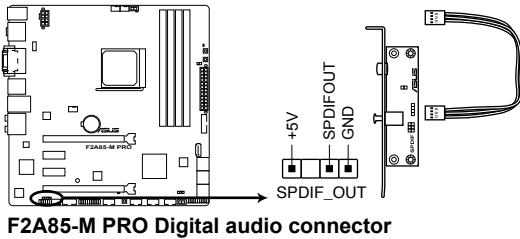

Ensure that the audio device of Sound playback is **Realtek High Definition Audio** (the name may be different based on the OS). Go to **Start > Control Panel > Sounds and Audio Devices > Sound Playback** to configure the setting.



The S/PDIF module is purchased separately.

## 6. System panel connector (20-8 pin PANEL)

This connector supports several chassis-mounted functions.

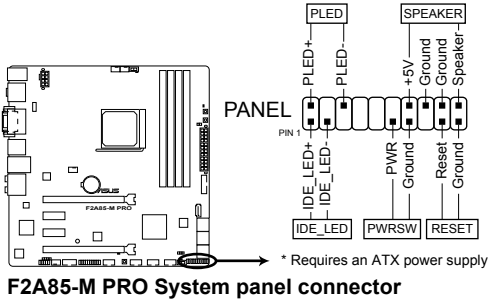

- **System power LED (2-pin PLED)**

This 2-pin connector is for the system power LED. Connect the chassis power LED cable to this connector. The system power LED lights up when you turn on the system power, and blinks when the system is in sleep mode.

- **Hard disk drive activity LED (2-pin IDE\_LED)**

This 2-pin connector is for the HDD Activity LED. Connect the HDD Activity LED cable to this connector. The IDE LED lights up or flashes when data is read from or written to the HDD.

- **System warning speaker (4-pin SPEAKER)**

This 4-pin connector is for the chassis-mounted system warning speaker. The speaker allows you to hear system beeps and warnings.

- **ATX power button/soft-off button (2-pin PWR SW)**

This connector is for the system power button. Pressing the power button turns the system on or puts the system in sleep or soft-off mode depending on the BIOS settings. Pressing the power switch for more than four seconds while the system is ON turns the system OFF.

- **Reset button (2-pin RESET)**

This 2-pin connector is for the chassis-mounted reset button for system reboot without turning off the system power.



## 7. Front panel audio connector (10-1 pin AAFP)

This connector is for a chassis-mounted front panel audio I/O module that supports either High Definition Audio or AC'97 audio standard. Connect one end of the front panel audio I/O module cable to this connector.

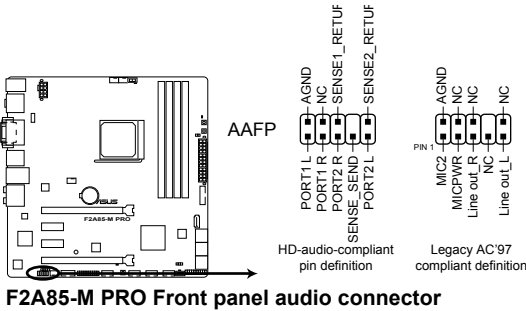

- We recommend that you connect a high-definition front panel audio module to this connector to avail of the motherboard high-definition audio capability.
- If you want to connect a high definition front panel audio module to this connector, set the **Front Panel Type** item in the BIOS to **[HD]**. See section 3.5.5 **Onboard Devices Configuration** for details.
- The front panel audio I/O module is purchased separately.

## 8. USB 3.0 connector (20-1 pin USB3\_34)

This connector is for the additional USB 3.0 ports. Connect the USB 3.0 bracket cable to this connector, then install the USB 3.0 bracket to the rear side of the chassis. If your chassis support customized front panel installation, with ASUS USB 3.0 header, you can have a front panel USB 3.0 solution.

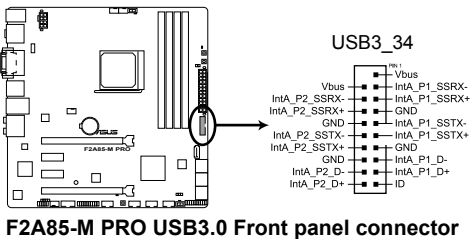

The USB 3.0 module is purchased separately.

**9. USB 2.0 connectors (10-1 pin USB34, USB56, USB78, USB910)**

These connectors are for USB 2.0 ports. Connect the USB module cable to any of these connectors, then install the module to a slot opening at the back of the system chassis. These USB connectors comply with USB 2.0 specification that supports up to 480Mbps connection speed.

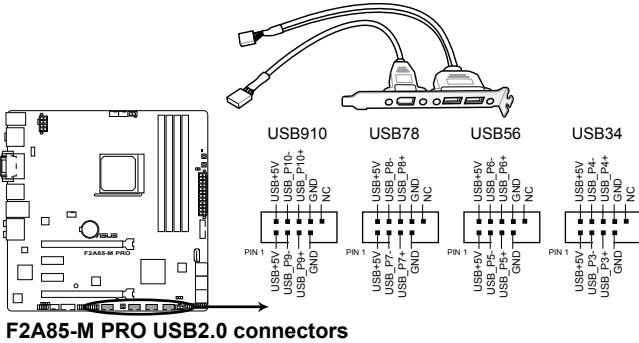

Never connect a 1394 cable to the USB connectors. Doing so will damage the motherboard!



The USB 2.0 module is purchased separately.

**10. Direct connector (2-pin DRCT)**

This connector is for the chassis-mounted button that supports the DirectKey function. Connect the button cable that supports DirectKey, from the chassis to this connector on the motherboard.

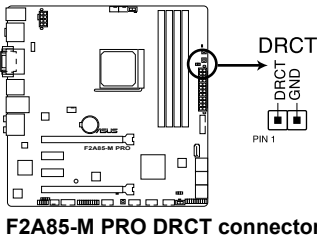

Ensure that your chassis comes with the button cable that supports the DirectKey feature. Refer to the technical documentation that came with the chassis for details.

## 11. TPM connector (20-1 pin TPM)

This connector supports a Trusted Platform Module (TPM) system, which securely store keys, digital certificates, passwords and data. A TPM system also helps enhance network security, protect digital identities, and ensures platform integrity.

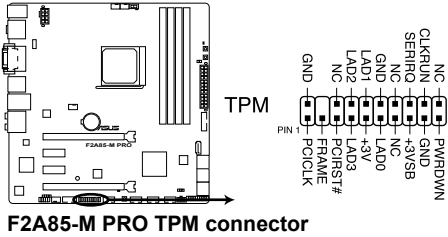

---

TPM module is purchased separately.

---



# Basic Installation

# 2

## 2.1 Building your PC system

### 2.1.1 Motherboard installation



The diagrams in this section are for reference only. The motherboard layout may vary with models, but the installation steps are the same for all models.

1. Install the ASUS Q-Shield to the chassis rear I/O panel.

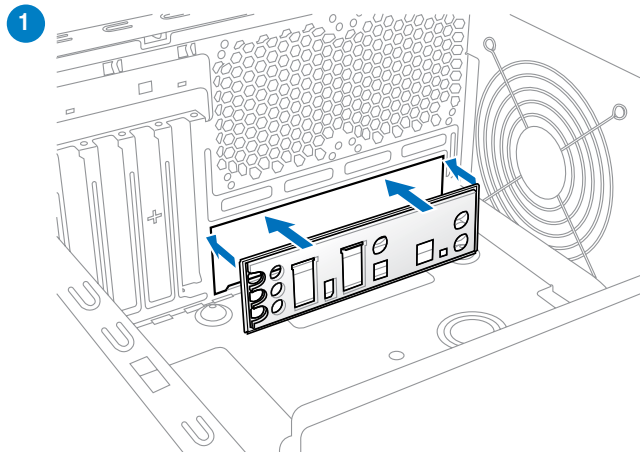

2. Place the motherboard into the chassis, ensuring that its rear I/O ports are aligned to the chassis' rear I/O panel.

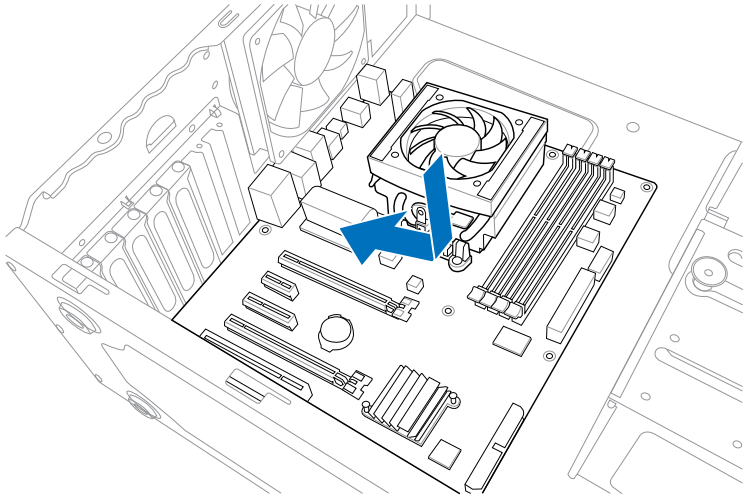

- Place nine screws into the holes indicated by circles to secure the motherboard to the chassis.

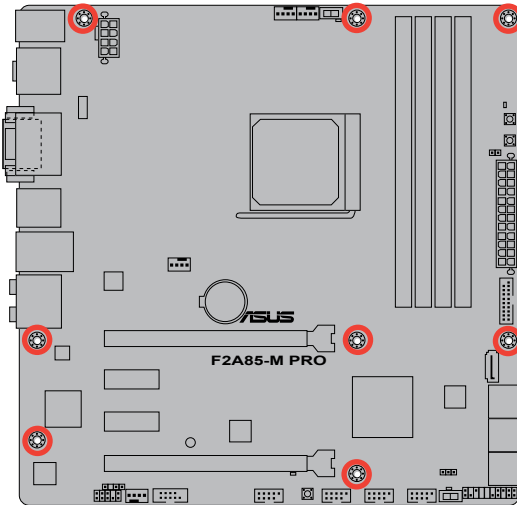
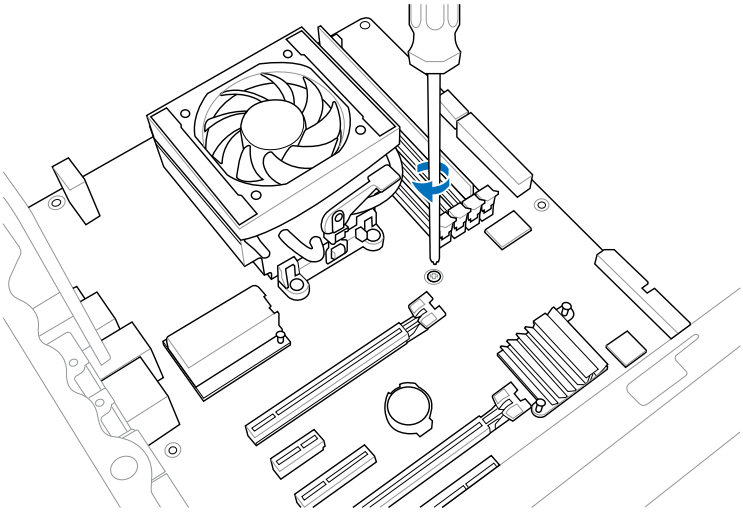

DO NOT overtighten the screws! Doing so can damage the motherboard.

## 2.1.2 APU installation



The AMD FM2 socket is compatible with AMD A-series accelerated processors. Ensure that you use a CPU designed for the FM2 socket. The CPU fits in only one correct orientation. **DO NOT** force the APU into the socket to prevent bending the connectors on the socket and damaging the APU!

1

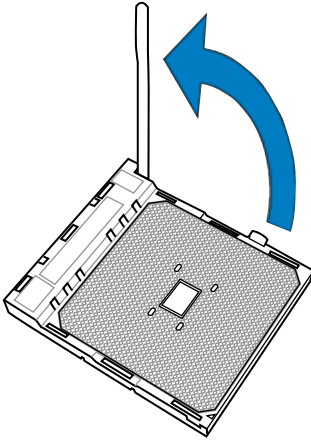

2

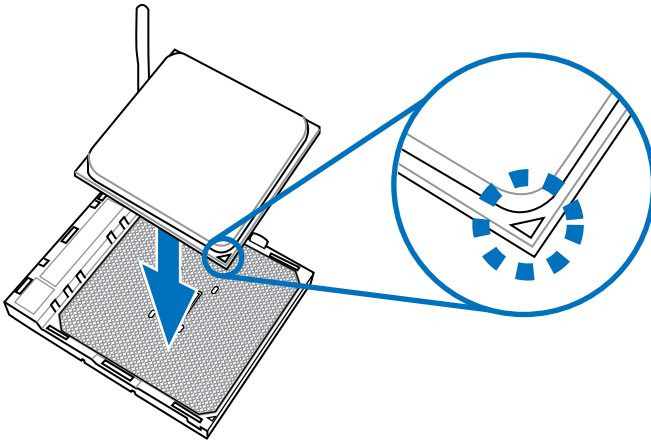



3

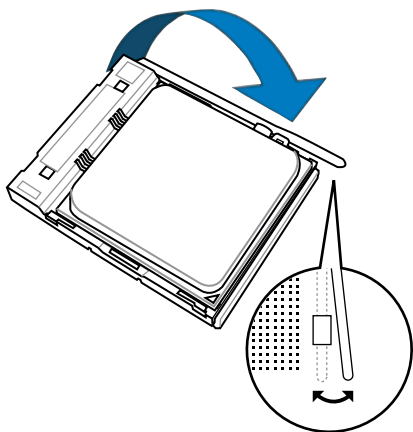

### 2.1.3 CPU heatsink and fan assembly installation

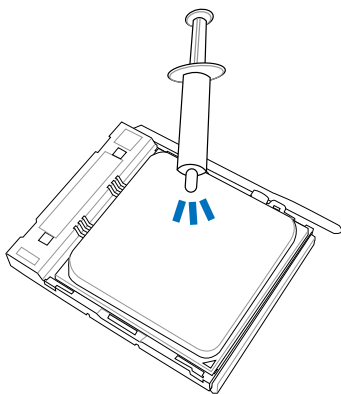

Apply the Thermal Interface Material to the CPU heatsink and CPU before you install the heatsink and fan if necessary.

To install the CPU heatsink and fan assembly

1

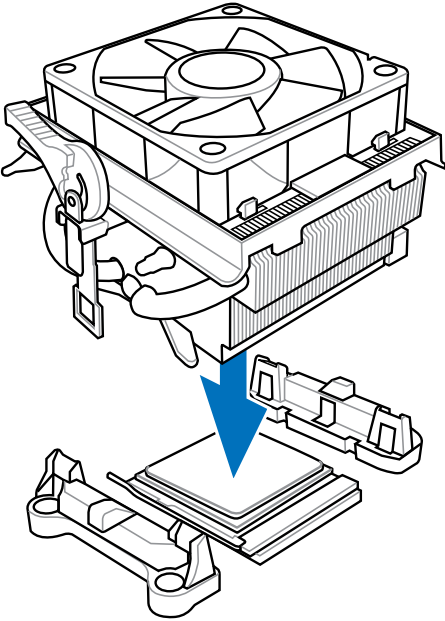

2

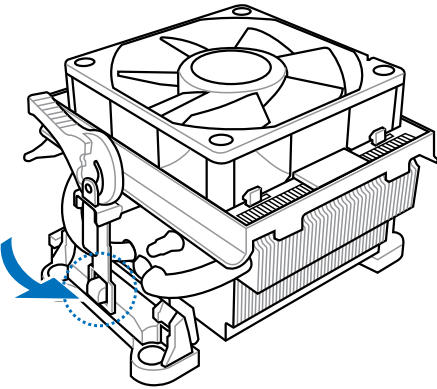

3

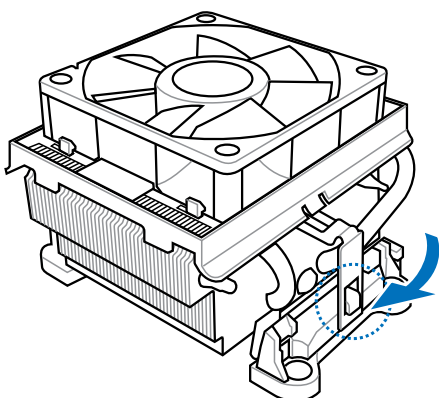

4

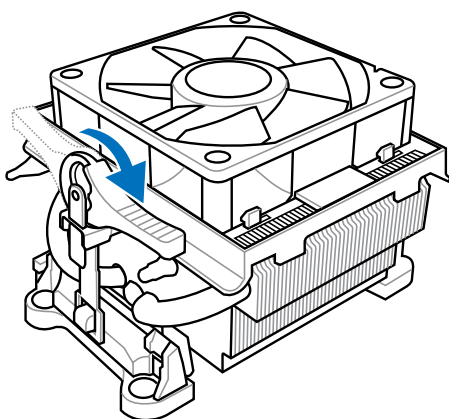

5

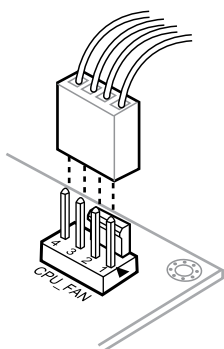

## 2.1.4 DIMM installation

1

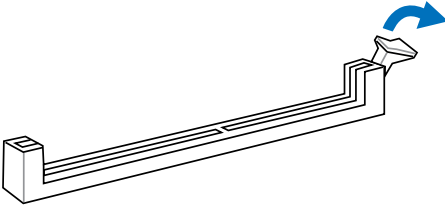

2

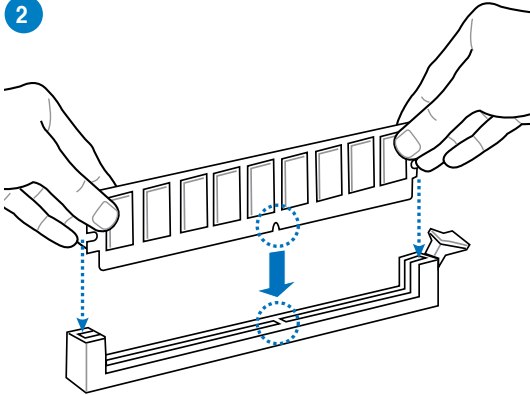

3

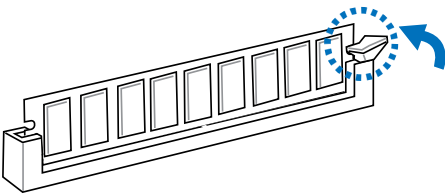

To remove a DIMM

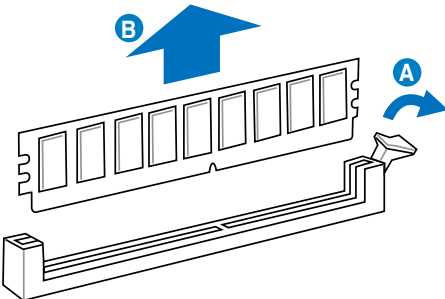

## 2.1.5 ATX Power connection

1

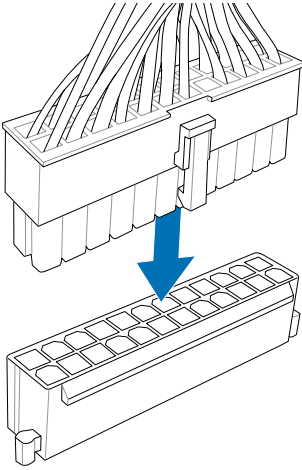

2

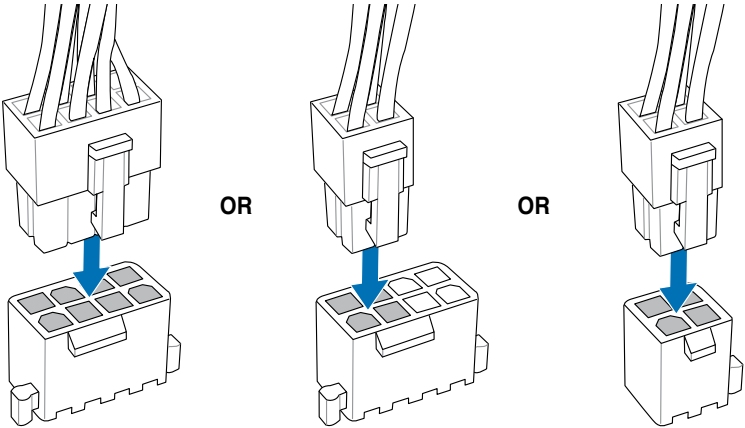

## 2.1.6 SATA device connection

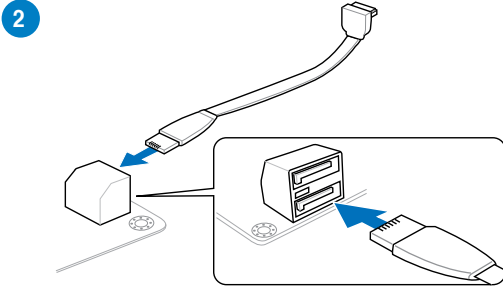
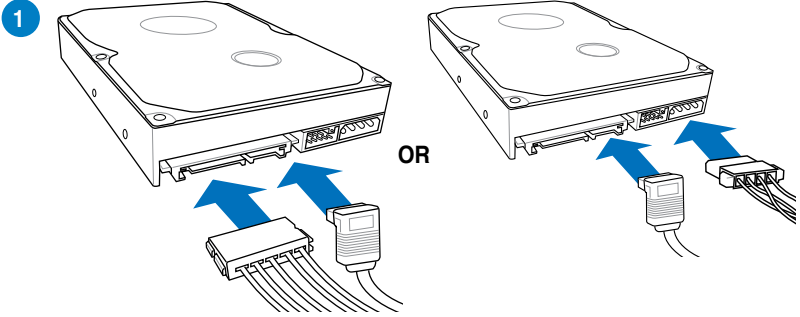

OR

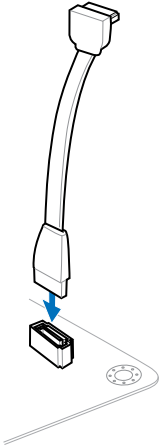

## 2.1.7 Expansion Card installation

To install PCIe x16 cards

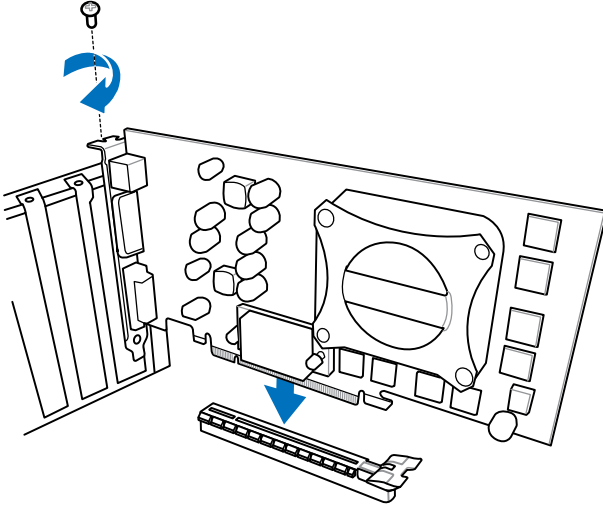

To install PCIe x1 cards

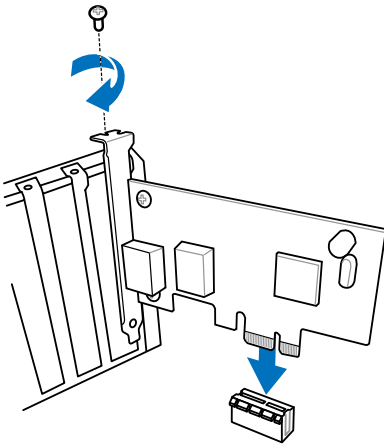

## 2.2 BIOS update utility

### 2.2.1 USB BIOS Flashback

USB BIOS Flashback allows you to easily update the BIOS without entering the existing BIOS or operating system. Simply insert a USB storage device to the USB port, press the USB BIOS Flashback button for three seconds, and the BIOS is updated automatically.

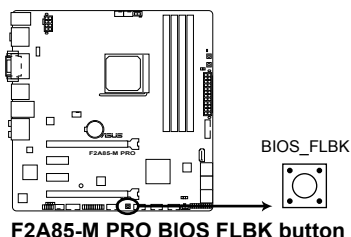

#### To use USB BIOS Flashback:

1. Place the bundled support DVD to the optical drive and install the USB BIOS Flashback Wizard. Follow the onscreen instructions to complete the installation.
2. Insert the USB storage device to the USB Flashback port.
3. Launch the USB BIOS Flashback Wizard to automatically download the latest BIOS version.
4. Press the BIOS Flashback button for three seconds until a flashing light appears, which indicates that the BIOS Flashback function is enabled.
5. Wait until the light goes out, indicating that the BIOS updating process is completed.

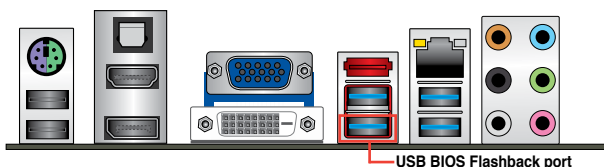

For more BIOS update utilities in BIOS setup, refer to the section Updating BIOS in Chapter 3.



- Do not unplug portable disk, power system, or press the CLR\_CMOS button while BIOS update is ongoing, otherwise update will be interrupted. In case of interruption, please follow the steps again.
- If the light flashes for five seconds and turns into a solid light, this means that the BIOS Flashback is not operating properly. This may be caused by improper installation of the USB storage device and filename/file format error. If this scenario happens, please restart the system to turn off the light.
- Updating BIOS may have risks. If the BIOS program is damaged during the process and results to the system's failure to boot up, please contact your local ASUS Service Center.



## 2.3 Motherboard rear and audio connections

### 2.3.1 Rear I/O connection

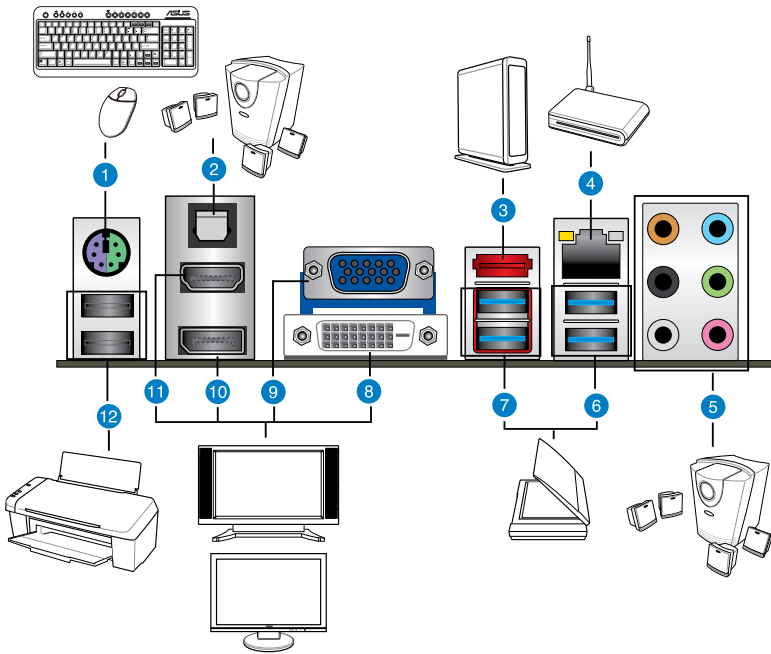

#### Rear panel connectors

1.	PS/2 keyboard/mouse combo port	7.	AMD USB 3.0 ports 1 and 2 support ASUS USB 3.0 Boost UASP Mode. Bottom part supports USB BIOS Flashback and USB Charger+
2.	Optical S/PDIF Out port	8.	DVI-D port
3.	eSATA port	9.	VGA port
4.	LAN (RJ-45) port*	10.	DisplayPort
5.	Audio I/O ports**	11.	HDMI port
6.	ASMedia USB 3.0 ports 3 and 4 support ASUS USB 3.0 Boost UASP Mode	12.	USB 2.0 ports 1 and 2

\* and \*\*: Refer to the tables on the next page for LAN port LEDs, and audio port definitions.



- DO NOT insert a different connector to the external SATA port.
- Due to USB 3.0 controller limitation, USB 3.0 devices can only be used under Windows® OS environment and after the USB 3.0 driver installation.
- USB 3.0 devices can only be used as data storage only.
- We strongly recommend that you connect USB 3.0 devices to USB 3.0 ports for faster and better performance for your USB 3.0 devices.
- USB3.0\_2 port supports USB Charger+ and USB BIOS Flashback.

### \* LAN ports LED indications

Activity Link LED		Speed LED	
Status	Description	Status	Description
OFF	No link	OFF	10 Mbps connection
ORANGE	Linked	ORANGE	100 Mbps connection
BLINKING	Data activity	GREEN	1 Gbps connection

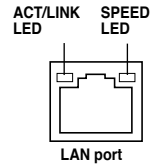

### \*\* Audio 2, 4, 6, or 8-channel configuration

Port	Headset 2-channel	4-channel	6-channel	8-channel
Light Blue	Line In	Line In	Line In	Line In
Lime	Line Out	Front Speaker Out	Front Speaker Out	Front Speaker Out
Pink	Mic In	Mic In	Mic In	Mic In
Orange	–	–	Center/Subwoofer	Center/Subwoofer
Black	–	Rear Speaker Out	Rear Speaker Out	Rear Speaker Out
Gray	–	–	–	Side Speaker Out



### Multiple display table

This table indicates whether the multiple display you want to use is supported or not.

Multiple display output	Supported	Not supported
DVI + D-Sub	•	
HDMI + D-Sub	•	
DVI + HDMI		•
DVI + DisplayPort	•	
D-Sub + DisplayPort	•	
HDMI + DisplayPort	•	
DVI + D-Sub + DisplayPort	•	
HDMI + D-Sub + DisplayPort	•	
HDMI + DVI + DisplayPort		•

## 2.3.2 Audio I/O connections

### Audio I/O ports

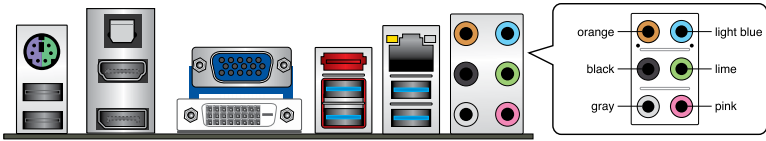

### Connect to Headphone and Mic

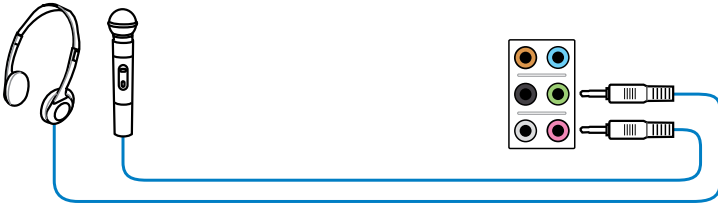

### Connect to Stereo Speakers

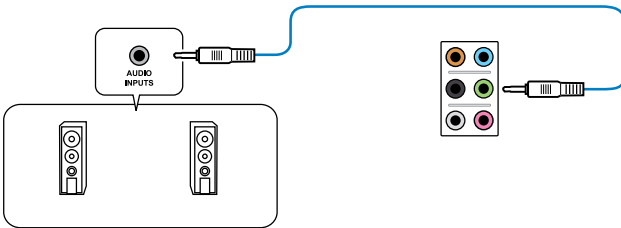

### Connect to 2.1 channel Speakers

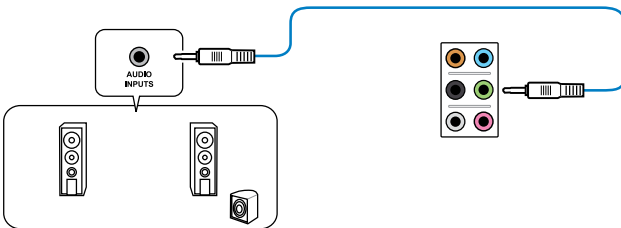

### Connect to 4.1 channel Speakers

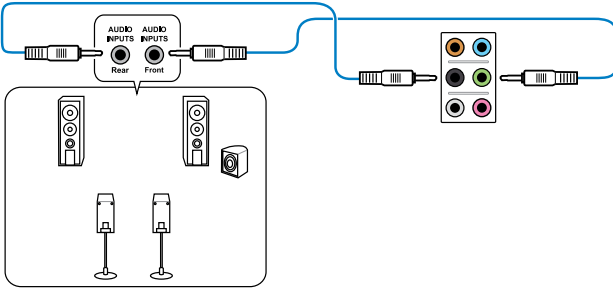

### Connect to 5.1 channel Speakers

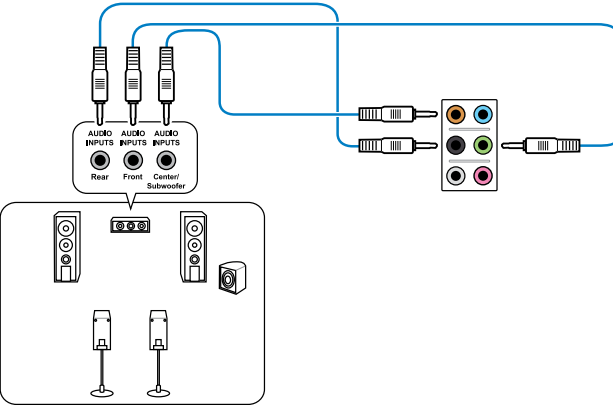

### Connect to 7.1 channel Speakers

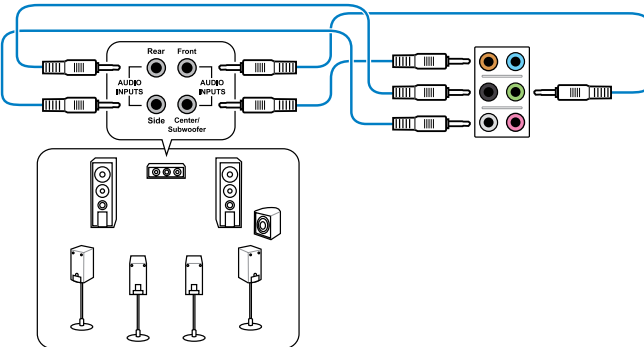

## 2.4 Starting up for the first time

1. After making all the connections, replace the system case cover.
2. Ensure that all switches are off.
3. Connect the power cord to the power connector at the back of the system chassis.
4. Connect the power cord to a power outlet that is equipped with a surge protector.
5. Turn on the devices in the following order:
  - a. Monitor
  - b. External SCSI devices (starting with the last device on the chain)
  - c. System power
6. After applying power, the system power LED on the system front panel case lights up. For systems with ATX power supplies, the system LED lights up when you press the ATX power button. If your monitor complies with the “green” standards or if it has a “power standby” feature, the monitor LED may light up or change from orange to green after the system LED turns on.

The system then runs the power-on self tests (POST). While the tests are running, the BIOS beeps (refer to the BIOS beep codes table) or additional messages appear on the screen. If you do not see anything within 30 seconds from the time you turned on the power, the system may have failed a power-on test. Check the jumper settings and connections or call your retailer for assistance.

BIOS Beep	Description
One short beep	VGA detected Quick boot set to disabled No keyboard detected
One continuous beep followed by two short beeps then a pause (repeated)	No memory detected
One continuous beep followed by three short beeps	No VGA detected
One continuous beep followed by four short beeps	Hardware component failure

7. At power on, hold down the <Delete> key to enter the BIOS Setup. Follow the instructions in Chapter 3.

## 2.5 Turning off the computer

While the system is ON, press the power button for less than four seconds to put the system on sleep mode or soft-off mode, depending on the BIOS setting. Press the power switch for more than four seconds to let the system enter the soft-off mode regardless of the BIOS setting.



# BIOS setup

# 3

## 3.1 Knowing BIOS



---

The new ASUS UEFI BIOS is a Unified Extensible Interface that complies with UEFI architecture, offering a user-friendly interface that goes beyond the traditional keyboard-only BIOS controls to enable a more flexible and convenient mouse input. You can easily navigate the new UEFI BIOS with the same smoothness as your operating system. The term "BIOS" in this user manual refers to "UEFI BIOS" unless otherwise specified.

---

BIOS (Basic Input and Output System) stores system hardware settings such as storage device configuration, overclocking settings, advanced power management, and boot device configuration that are needed for system startup in the motherboard CMOS. In normal circumstances, the default BIOS settings apply to most conditions to ensure optimal performance. **DO NOT change the default BIOS settings** except in the following circumstances:

- An error message appears on the screen during the system bootup and requests you to run the BIOS Setup.
- You have installed a new system component that requires further BIOS settings or update.



---

Inappropriate BIOS settings may result to instability or boot failure. **We strongly recommend that you change the BIOS settings only with the help of a trained service personnel.**

---



---

When downloading or updating the BIOS file, rename it as **F2A85MP.CAP** for this motherboard.

---

## 3.2 BIOS setup program

Use the BIOS Setup to update the BIOS or configure its parameters. The BIOS screen include navigation keys and brief onscreen help to guide you in using the BIOS Setup program.

### Entering BIOS at startup

To enter BIOS Setup at startup:

- Press <Delete> during the Power-On Self Test (POST). If you do not press <Delete>, POST continues with its routines.

### Entering BIOS Setup after POST

To enter BIOS Setup after POST:

- Press <Ctrl>+<Alt>+<Delete> simultaneously.
- Press the reset button on the system chassis.
- Press the power button to turn the system off then back on. Do this option only if you failed to enter BIOS Setup using the first two options.



- 
- The BIOS setup screens shown in this section are for reference purposes only, and may not exactly match what you see on your screen.
  - Ensure that a USB mouse is connected to your motherboard if you want to use the mouse to control the BIOS setup program.
  - If the system becomes unstable after changing any BIOS setting, load the default settings to ensure system compatibility and stability. Select the **Load Optimized Defaults** item under the **Exit** menu or press hotkey <F5>. See section 3.9 **Exit Menu** for details.
  - If the system fails to boot after changing any BIOS setting, try to clear the CMOS and reset the motherboard to the default value. See section 1.2.5 **Onboard buttons and switches** for information on how to erase the RTC RAM via the Clear CMOS button.
  - The BIOS setup program does not support the bluetooth devices.
- 

### BIOS menu screen

The BIOS Setup program can be used under two modes: **EZ Mode** and **Advanced Mode**. You can change modes from the **Exit** menu or from the **Exit/Advanced Mode** screen.



### 3.2.1 EZ Mode

By default, the EZ Mode screen appears when you enter the BIOS setup program. The EZ Mode provides you an overview of the basic system information, and allows you to select the display language, system performance mode and boot device priority. To access the Advanced Mode, click **Exit/Advanced Mode**, then select **Advanced Mode** or press <F7> hot key for the advanced BIOS settings.



The default screen for entering the BIOS setup program can be changed. Refer to the **Setup Mode** item in section 3.7 **Boot menu** for details.

Displays the CPU/motherboard temperature, CPU/5V/3.3V/12V voltage output, CPU/chassis/power fan speed

Selects the display language of the BIOS setup program

Clicks to display all fan speeds if available

Exits the BIOS setup program without saving the changes, saves the changes and resets the system, or enters the Advanced Mode

Displays the Advanced mode functions

Displays the Advanced mode menus

Power Saving mode

Normal mode

ASUS Optimal mode

Loads optimized default

Displays the system properties of the selected mode on the right hand side



- The boot device options vary depending on the devices you installed to the system.
- The **Boot Menu(F8)** button is available only when the boot device is installed to the system.

### 3.2.2 Advanced Mode

The Advanced Mode provides advanced options for experienced end-users to configure the BIOS settings. The figure below shows an example of the Advanced Mode. Refer to the following sections for the detailed configurations.



To access the Advanced Mode, click **Exit**, then select **Advanced Mode** or press **F7** hotkey.



#### Menu bar

The menu bar on top of the screen has the following main items:

<b>Main</b>	For changing the basic system configuration
<b>AI Tweaker</b>	For changing the overclocking settings
<b>Advanced</b>	For changing the advanced system settings
<b>Monitor</b>	For displaying the system temperature, power status, and changing the fan settings.
<b>Boot</b>	For changing the system boot configuration
<b>Tool</b>	For configuring options for special functions
<b>Exit</b>	For selecting the exit options and loading default settings

## Menu items

The highlighted item on the menu bar displays the specific items for that menu. For example, selecting **Main** shows the Main menu items.

The other items (Ai Tweaker, Advanced, Monitor, Boot, Tool, and Exit) on the menu bar have their respective menu items.

## Back button

This button appears when entering a submenu. Press <Esc> or use the USB mouse to click this button to return to the previous menu screen.

## Submenu items

A greater than sign (>) before each item on any menu screen means that the item has a submenu. To display the submenu, select the item and press <Enter>.

## Pop-up window

Select a menu item and press <Enter> to display a pop-up window with the configuration options for that item.

## Scroll bar

A scroll bar appears on the right side of a menu screen when there are items that do not fit on the screen. Press the Up/Down arrow keys or <Page Up> / <Page Down> keys to display the other items on the screen.

## Navigation keys

At the bottom right corner of the menu screen are the navigation keys for the BIOS setup program. Use the navigation keys to select items in the menu and change the settings.

## General help

At the top right corner of the menu screen is a brief description of the selected item. Use <F12> key to capture the BIOS screen and save it to the removable storage device.

## Configuration fields

These fields show the values for the menu items. If an item is user-configurable, you can change the value of the field opposite the item. You cannot select an item that is not user-configurable.

A configurable field is highlighted when selected. To change the value of a field, select it and press <Enter> to display a list of options.

### 3.3 Main menu

The Main menu screen appears when you enter the Advanced Mode of the BIOS Setup program. The Main menu provides you an overview of the basic system information, and allows you to set the system date, time, language, and security settings.



### Security

The Security menu items allow you to change the system security settings.



- If you have forgotten your BIOS password, erase the CMOS Real Time Clock (RTC) RAM to clear the BIOS password. See section 1.2.5 **Onboard buttons and switches** for information on how to erase the RTC RAM via the Clear CMOS button.
- The Administrator or User Password items on top of the screen show the default [Not Installed]. After you set a password, these items show [Installed].

## Administrator Password

If you have set an administrator password, we recommend that you enter the administrator password for accessing the system. Otherwise, you might be able to see or change only selected fields in the BIOS setup program.

### To set an administrator password:

1. Select the **Administrator Password** item and press <Enter>.
2. From the **Create New Password** box, key in a password, then press <Enter>.
3. Confirm the password when prompted.

### To change an administrator password:

1. Select the **Administrator Password** item and press <Enter>.
2. From the **Enter Current Password** box, key in the current password, then press <Enter>.
3. From the **Create New Password** box, key in a new password, then press <Enter>.
4. Confirm the password when prompted.

To clear the administrator password, follow the same steps as in changing an administrator password, but press <Enter> when prompted to create/confirm the password. After you clear the password, the **Administrator Password** item on top of the screen shows **Not Installed**.

## User Password

If you have set a user password, you must enter the user password for accessing the system. The User Password item on top of the screen shows the default Not Installed. After you set a password, this item shows Installed.

### To set a user password:

1. Select the **User Password** item and press <Enter>.
2. From the **Create New Password** box, key in a password, then press <Enter>.
3. Confirm the password when prompted.

**To change a user password:**

1. Select the **User Password** item and press <Enter>.
2. From the **Enter Current Password** box, key in the current password, then press <Enter>.
3. From the **Create New Password** box, key in a new password, then press <Enter>.
4. Confirm the password when prompted.

To clear the user password, follow the same steps as in changing a user password, but press <Enter> when prompted to create/confirm the password. After you clear the password, the **User Password** item on top of the screen shows **Not Installed**.

### 3.4 Ai Tweaker menu

The Ai Tweaker menu items allow you to configure overclocking-related items.



Be cautious when changing the settings of the Ai Tweaker menu items. Incorrect field values can cause the system to malfunction.



The configuration options for this section vary depending on the CPU and DIMM model you installed on the motherboard.

Scroll down to display other BIOS items.



### **Target CPU Speed : xxxxMHz**

Displays the current CPU speed.

### **Target DRAM Speed : xxxxMHz**

Displays the current DRAM speed.

## **3.4.1 Ai Overclock Tuner [Auto]**

Allows you to select the CPU overclocking options to achieve the desired CPU internal frequency. Select any of these preset overclocking configuration options:

[Auto] Loads the optimal settings for the system.

[Manual] Allows you to individually set overclocking parameters.

### **APU Frequency [XXX]**

This item appears only when you set the **Ai Overclock Tuner** item to [Manual]. Use the <+> and <-> keys to adjust the value. You can also key in the desired value using the numeric keypad. The values range from 90.0MHz to 300.0MHz.

## **3.4.2 Memory Frequency [Auto]**

Allows you to set the memory operating frequency.

Configuration options: [Auto] DDR3-800MHz] [DDR3-1066MHz] [DDR3-1333MHz] [DDR3-1600MHz] [DDR3-1866MHz] [DDR3-2133MHz] [DDR3-2400MHz].



---

Selecting a very high memory frequency may cause the system to become unstable! If this happens, revert to the default setting.

---

## **3.4.3 APU Multiplier [Auto]**

Allows you to set the multiplier between the APU Core Clock and the APU Bus Frequency. Use the <+> and <-> keys to adjust the value. You can also key in the desired value using the numeric keypad.

## **3.4.4 NB Frequency [Auto]**

Automatically adjusts the NB Frequency.

## **3.4.5 EPU Power Saving Mode [Disabled]**

Allows you to enable or disable the EPU power saving function.

Configuration options: [Disabled] [Enabled]

### **EPU Setting [Auto]**

This item appears only when The EPU Power Saving Mode is set to [Enabled] and allows you to set power saving mode. Configuration options: [Auto] [Light Power Saving Mode] [Medium Power Saving Mode] [Max Power Saving Mode]

### 3.4.6 GPU Boost

Allows you to configure the GPU Boost settings.

- [Auto] GPU is set to its optimized settings.
- [Turbo] Select to achieve better 3D performance.
- [Extreme] Select to get an excellent visual performance.
- [Manual] Select to manually set your preferred value.

### 3.4.7 OC Tuner

OC Tuner automatically overclocks the frequency and voltage of CPU and DRAM for enhancing the system performance. Press <Enter> and select **OK** to start automatic overlocking.

### 3.4.8 DRAM Timing Control

The sub-items in this menu allow you to set the DRAM timing control features. Use the <+> and <-> keys to adjust the value. To restore the default setting, type [auto] using the keyboard and press <Enter>.



---

Changing the values in this menu may cause the system to become unstable! If this happens, revert to the default settings.

---

### 3.4.9 DIGI + VRM

#### CPU Load Line Calibration [Auto]

CPU Load-line Calibration is defined by AMD VRM specifications and affects CPU voltage. The CPU working voltage will decrease proportionally to CPU loading. Higher load-line calibration would get higher voltage and better overlocking performance, but increase the CPU and VRM thermal. This item allows you to adjust the voltage range from the following percentages to boost the system performance: 0% (Regular), 25% (Medium), 50% (High), 75% (Ultra High) and 100% (Extreme). Configuration options: [Auto] [Regular] [Medium] [High] [Ultra High] [Extreme]



---

The actual performance boost may vary depending on your CPU specification.

---

#### CPU/NB Load Line Calibration [Auto]

Allows you to select the CPU/NB Load-Line Calibration mode.

Configuration options: [Auto] [Regular] [High] [Extreme]

#### CPU Current Capability [100%]

This item provides wider total power range for overlocking. A higher value brings a wider total power range and extends the overlocking frequency range simultaneously. Configuration options: [100%] [110%] [120%] [130%] [140%]

#### CPU/NB Current Capability [100%]

This item provides wider total power range for overlocking. A higher value brings a wider total power range and extends the overlocking frequency range simultaneously. Configuration options: [100%] [110%] [120%] [130%]



### CPU Power Phase Control [Standard]

Phase number is the number of working VRM phase. Increasing phase number under heavy system loading to get more transient and better thermal performance. Reducing phase number under light system loading to increase VRM efficiency.

[Standard] Proceeds phase control depending on the CPU loading.

[Optimized] Loads the ASUS optimized phase tuning profile.

[Extreme] Proceeds the full phase mode.

[Manual Adjustment] Allows manual adjustment.

### CPU Voltage Frequency [Auto]

Switching frequency will affect the VRM transient response and component thermal. Setting a higher frequency gets faster transient response.

[Auto] Allows you to enable or disable the Spread Spectrum item.

[Manual] Allows you to manually set the frequency with a 10k Hz interval.

### VRM Fixed Frequency Mode [xxx]

This item appears only when you set the CPU Voltage Frequency item to [Manual] and allows you to set a fixed VRM frequency. Use the <+> and <-> keys to adjust the value. The values range from 200k Hz to 400k Hz with a 10k Hz interval.

### VRM Spread Spectrum [Disabled]

This item appears only when you set the CPU Voltage Frequency item to [Auto] and allows you to enable the spread spectrum to enhance system stability.

### CPU Power Duty Control [T.Probe]

[T.Probe] Maintains the VRM thermal balance.

[Extreme] Maintains the VRM current balance.



Do not remove the thermal module while changing the DIGI+VRM related parameters. The thermal conditions should be monitored.

## 3.4.10 CPU Voltage [Offset Mode]

[Offset Mode] To offset the voltage by a positive or negative value.

[Manual Mode] To set the voltage manually.

### CPU Offset Mode Sign [+]

This item appears only when you set the CPU Voltage item to [Offset Mode].

[+] To offset the voltage by a positive value.

[-] To offset the voltage by a negative value.

### CPU Offset Voltage [Auto]

Allows you to set the CPU Offset voltage. The values range from 0.00625V to 0.500V with a 0.00625V interval.



Refer to the CPU documentation before setting the CPU voltage. Setting a high voltage may damage the CPU permanently, and setting a low voltage may make the system unstable.

### **VDDNB Offset Mode Sign [+]**

This item appears only when you set the CPU Voltage item to [Offset Mode].

- [+] To offset the voltage by a positive value.
- [-] To offset the voltage by a negative value.

### **VDDNB Offset Voltage [Auto]**

Allows you to set the VDDNB Offset voltage. The values range from 0.00625V to 0.500V with a 0.00625V interval.

### **CPU Manual Voltage [Auto]**

This item appears only when you set the **CPU Voltage** item to [Manual Mode] and allows you to manually set the CPU voltage. The values range from 0.800V to 1.550V with a 0.0125V interval.

### **VDDNB Manual Voltage [Auto]**

This item appears only when you set the CPU Voltage item to [Manual Mode] and allows you to manually set the VDDNB voltage. The values range from 0.800V to 1.550V with a 0.0125V interval.

## **3.4.11 DRAM Voltage [Auto]**

Allows you to set the DRAM voltage. The values range from 1.35V to 2.135V with a 0.01V interval.

## **3.4.12 SB 1.1V Voltage [Auto]**

Allows you to set the Southbridge 1.1V voltage. The values range from 1.1V to 1.4V with a 0.01V interval.

## **3.4.13 1.1Vsb Voltage [Auto]**

Allows you to set the 1.1Vsb voltage. The values range from 1.1000V to 1.4000V with a 0.1V interval.

## **3.4.14 APU1.2V Voltage [Auto]**

Allows you to set the APU (Accelerated Processor Unit) 1.2V voltage. The values range from 1.2000V to 1.8000V with a 0.01V interval.

## **3.4.15 VDDA Voltage [Auto]**

Allows you to set the VDDA voltage. The values range from 2.5000V to 2.8000V with a 0.1V interval.

## **3.4.16 NB VREF Voltage [Auto]**

Allows you to set the NB VREF voltage. The values range from 0.435V to 1.065V with a 0.005V interval.

## **3.4.17 DRAM VREFCA Voltage [Auto]**

Allows you to set the DRAM VREFCA voltage. The values range from 0.435V to 1.065V with a 0.005V interval.

### 3.4.18 DRAM VREFDQ Voltage [Auto]

Allows you to set the DRAM VREFDQ voltage. The values range from 0.435V to 1.065V with a 0.005V interval.



- The values of the **CPU Offset Voltage**, **CPU Manual Voltage**, **VDDNB Offset Voltage**, **VDDNB Manual Voltage**, **DRAM Voltage**, **SB 1.1V Voltage**, **1.1Vsb Voltage**, **APU1.2V Voltage**, **VDDA Voltage**, **NB VREF Voltage**, **DRAM VREFCA Voltage**, and **DRAM VREFDQ Voltage** items are labeled in different color, indicating the risk levels of high voltage settings.
- The system may need better cooling system to work stably under high voltage settings.

### 3.4.19 CPU Spread Spectrum [Auto]

[Auto]	Automatic configuration.
[Disabled]	Enhances the BCLK overclocking ability.
[Enabled]	Sets to [Enabled] for EMI control.

## 3.5 Advanced menu

The Advanced menu items allow you to change the settings for the CPU and other system devices.



Be cautious when changing the settings of the Advanced menu items. Incorrect field values can cause the system to malfunction.



### 3.5.1 CPU Configuration

The items in this menu show the CPU-related information that the BIOS automatically detects.



The items shown in submenu may be different due to the CPU you installed.

#### AMD PowerNow function [Enabled]

Enables or disables the AMD PowerNow function. Configuration options: [Enabled] [Disabled]

#### NX Mode [Enabled]

Enables or disables the No-execute page protection function.

Configuration options: [Enabled] [Disabled]

### **SVM [Enabled]**

Enables or disables CPU virtualization. Configuration options: [Disabled] [Enabled]

### **CPB Mode [Auto]**

Allows you to disable CPB mode function. Configuration options: [Auto] [Disabled]

### **C6 Mode [Enabled]**

Enables or disables C6 mode function. Configuration options: [Disabled] [Enabled]

### **IOMMU [Disabled]**

Enables or disables IOMMU support. Configuration options: [Disabled] [Enabled]

## **3.5.2 SATA Configuration**

While entering Setup, the BIOS automatically detects the presence of SATA devices. The SATA Port items show **Not Present** if no SATA device is installed to the corresponding SATA port.

### **OnChip SATA Channel [Enabled]**

Enables or disables onboard channel SATA port. Configuration options: [Disabled] [Enabled]

### **OnChip SATA Type [AHCI]**

Allows you to set the SATA configuration.

- [IDE] Set to [IDE] when you want to use the Serial ATA hard disk drives as Parallel ATA physical storage devices.
- [RAID] Set to [RAID] when you want to create a RAID configuration from the SATA hard disk drives.
- [AHCI] Set to [AHCI] when you want the SATA hard disk drives to use the AHCI (Advanced Host Controller Interface). The AHCI allows the onboard storage driver to enable advanced Serial ATA features that increases storage performance on random workloads by allowing the drive to internally optimize the order of commands.

### **SATA Port 5/6/7, ESATA [AHCI]**

This item only appears when the OnChip SATA Type is set to [RAID] or [AHCI]. If Port 5/6/7 are configured as [AHCI], the ports can only be used under OS with driver installed. Set to [IDE] instead of [AHCI] to access devices on Port 5/6/7 before entering OS. Configuration options: [AHCI] [IDE]

### **Board SATA RAID ROM [Legacy ROM]**

This item only appears when the OnChip SATA Type is set to [RAID].

- [Disabled] Disables this function.
- [Legacy ROM] Select this option when using legacy operating systems.
- [UEFI DRIVER] Select this option when using UEFI systems.

### OnChip SATA MAX Speed [SATA 6.0Gb/s]

Sets the maximum onboard SATA port speed. Configuration options: [SATA 6.0Gb/s] [SATA 3.0Gb/s]

### S.M.A.R.T. Status Check [Enabled]

S.M.A.R.T. (Self-Monitoring, Analysis and Reporting Technology) is a monitor system. When read/write of your hard disk errors occur, this feature allows the hard disk to report warning messages during the POST. Configuration options: [Enabled] [Disabled]

## 3.5.3 USB Configuration

The items in this menu allow you to change the USB-related features.



---

The **USB Devices** item shows the auto-detected values. If no USB device is detected, the item shows None.

---

### Legacy USB Support [Enabled]

- [Enabled] Enables the support for USB devices on legacy operating systems (OS).
- [Disabled] The USB devices can be used only for the BIOS setup program.
- [Auto] Allows the system to detect the presence of USB devices at startup. If detected, the USB controller legacy mode is enabled. If no USB device is detected, the legacy USB support is disabled.

### Legacy USB3.0 Support [Enabled]

- [Enabled] Enables the support for USB 3.0 devices on legacy operating systems (OS).
- [Disabled] Disables the function.

### EHCI Hand-off [Disabled]

- [Enabled] Enables the support for operating systems without an EHCI hand-off feature.
- [Disabled] Disables the function.

## 3.5.4 NB Configuration

### IGFX Multi-Monitor [Disabled]

Enables or disables the Internal Graphics Device Multi-Monitor support for add-on VGA devices. And the memory size of Internal Graphics Device will keep memory reserved. Configuration options: [Disabled] [Enabled]

### Primary Video Device [PCIe / PCI Video]

Selects the primary display device. Configuration options: [IGFX Video] [PCIe / PCI Video]

### **Integrated Graphics [Auto]**

Enables the integrated graphics controller. Configuration options: [Auto] [Force]

### **UMA Frame Buffer Size [Auto]**

This item appears only when you set the previous item to [Force]. Configuration options: [Auto] [32M] [64M] [128M] [256M] [512M] [1G] [2G]

### **HDMI/DVI Port Output [Auto]**

Sets the HDMI/DVI port output type. Configuration options: [Auto] [HDMI] [DVI]

### **PCIEX16\_1 [Auto]**

Configuration options: [Auto] [Force X16] [Force X8]

## **3.5.5 Onboard Devices Configuration**

### **HD Audio Device [Enabled]**

[Enabled] Enables the High Definition Audio Controller.

[Disabled] Disables the controller.



---

The following two items appear only when you set the **HD Audio Device** item to [Enabled].

---

### **Front Panel Type [HD]**

Allows you to set the front panel audio connector (AAFP) mode to legacy AC'97 or high-definition audio depending on the audio standard that the front panel audio module supports.

[HD] Sets the front panel audio connector (AAFP) mode to high definition audio.

[AC97] Sets the front panel audio connector (AAFP) mode to legacy AC'97.

### **SPDIF Out Type [SPDIF]**

[SPDIF] Sets to [SPDIF] for SPDIF audio output.

[HDMI] Sets to [HDMI] for HDMI audio output.

### **Realtek LAN Controller [Enabled]**

[Enabled] Enables the Realtek LAN controller.

[Disabled] Disables the controller.

### **Realtek PXE OPROM [Disabled]**

This item appears only when you set the Realtek LAN Controller item to [Enabled] and allows you to enable or disable the Rom Help of the Realtek LAN controller.

Configuration options: [Enabled] [Disabled]

### **Asmedia USB 3.0 Controller [Enabled]**

[Enabled] Enables the onboard USB 3.0 controller.

[Disabled] Disables the controller.

### **Asmedia USB 3.0 Battery Charging Support [Enabled]**

This item appears only when the Asmedia USB 3.0 Controller item is set to [Enabled].

- [Enabled] Enables the Asmedia USB 3.0 battery charging function.
- [Disabled] Disables this function

### **Serial Port Configuration**

The sub-items in this menu allow you to set the serial port configuration.

#### **Serial Port [Enabled]**

Allows you to enable or disable the serial port (COM).

Configuration options: [Enabled] [Disabled]

#### **Change Settings [IO=3F8h; IRQ=4]**

Allows you to select the Serial Port base address.

Configuration options: [IO=3F8h; IRQ=4] [IO=2F8h; IRQ=3] [IO=3E8h; IRQ=4] [IO=2E8h; IRQ=3]

## **3.5.6 APM**

### **Restore AC Power Loss [Power Off]**

- [Power On] The system goes into on state after an AC power loss.
- [Power Off] The system goes into off state after an AC power loss.
- [Last State] The system goes into either off or on state, whatever the system state was before the AC power loss.

### **Power On By PS/2 Keyboard [Disabled]**

- [Disabled] Disables the Power On by a PS/2 keyboard.
- [Space Bar] Sets the Space Bar on the PS/2 keyboard to turn on the system.
- [Ctrl-Esc] Sets the Ctrl+Esc key on the PS/2 keyboard to turn on the system.
- [Power Key] Sets Power key on the PS/2 keyboard to turn on the system. This feature requires an ATX power supply that provides at least 1A on the +5VSB lead.

### **Power On By PS/2 Mouse [Disabled]**

- [Disabled] Disables the Power On by a PS/2 mouse.
- [Enabled] Enables the Power On by a PS/2 mouse. This feature requires an ATX power supply that provides at least 1A on the +5VSB lead.

### **Power On By PME [Disabled]**

- [Disabled] Disables the PME to wake up by PCI/PCIE devices.
- [Enabled] Allows you to turn on the system through a PCI/PCIE LAN or modem card. This feature requires an ATX power supply that provides at least 1A on the +5VSB lead.

### **Power On By Ring [Disabled]**

- [Disabled] Disables Ring to generate a wake event.
- [Enabled] Enables Ring to generate a wake event.



### **Power On By RTC [Disabled]**

[Disabled] Disables RTC to generate a wake event.

[Enabled] When set to [Enabled], the items RTC Alarm Date (Days) and Hour/Minute/Second will become user-configurable with set values.

## **3.5.7 Network Stack**

### **Network Stack [Disabled]**

This item allows user to disable or enable the UEFI network stack.

Configuration options: [Disabled] [Enabled]

### **Ipv4 PXE Support [Enabled]**

This item appears only when you set the Network Stack item to [Enabled]. When this item is disabled, the IPV4 PXE boot option will not be created.

Configuration options: [Disabled] [Enabled]

### **Ipv6 PXE Support [Enabled]**

This item appears only when you set the Network Stack item to [Enabled]. When this item is disabled, the IPV6 PXE boot option will not be created.

Configuration options: [Disabled] [Enabled]

### 3.6 Monitor menu

The Monitor menu displays the system temperature/power status, and allows you to change the fan settings.

Scroll down to display the other BIOS items.



#### 3.6.1 CPU Temperature / MB Temperature [xxx°C/xxx°F]

The onboard hardware monitor automatically detects and displays the CPU and motherboard temperatures. Select **Ignore** if you do not wish to display the detected temperatures.

#### 3.6.2 CPU\_FAN Speed [xxxx RPM] or [Ignore] / [N/A]

##### CHA\_FAN1/2/3 Speed [xxxx RPM] or [Ignore] / [N/A]

The onboard hardware monitor automatically detects and displays the CPU and chassis fan speeds in rotations per minute (RPM). If the fan is not connected to the motherboard, the field shows N/A. Select **Ignore** if you do not wish to display the detected speed.

#### 3.6.3 CPU Voltage, 3.3V Voltage, 5V Voltage, 12V Voltage

The onboard hardware monitor automatically detects the voltage output through the onboard voltage regulators. Select **Ignore** if you do not want to detect this item.

### 3.6.4 CPU\_FAN Q-Fan Control [Disabled]

[Disabled] Disables the CPU Q-Fan control feature.

[Enabled] Enables the CPU Q-Fan control feature.

#### CPU\_FAN Speed Low Limit [200 RPM]

This item appears only when you enable the **CPU\_FAN Q-Fan Control** feature and allows you to disable or set the CPU fan warning speed. Configuration options: [Ignore] [200 RPM] [300 RPM] [400 RPM] [500 RPM] [600 RPM]

#### CPU\_FAN Fan Profile [Standard]

This item appears only when you enable the CPU\_FAN Q-Fan Control feature and allows you to set the appropriate performance level of the CPU fan.

[Standard] Sets to [Standard] to make the CPU fan automatically adjust depending on the CPU temperature.

[Silent] Sets to [Silent] to minimize the fan speed for quiet CPU fan operation.

[Turbo] Sets to [Turbo] to achieve maximum CPU fan speed.

[Manual] Sets to [Manual] to assign detailed fan speed control parameters.



---

The following four items appear only when you set CPU\_FAN Fan Profile to [Manual].

---

#### **CPU\_FAN Upper Temperature [70]**

Use the <+> and <-> keys to adjust the upper limit of the CPU temperature. The values range from 20°C to 75°C.

#### **CPU\_FAN Fan Max. Duty Cycle(%) [100]**

Use the <+> and <-> keys to adjust the maximum CPU fan duty cycle. The values range from 20% to 100%. When the CPU temperature reaches the upper limit, the CPU fan will operate at the maximum duty cycle.

#### **CPU\_FAN Lower Temperature [20]**

Displays the lower limit of the CPU temperature.

#### **CPU\_FAN Fan Min. Duty Cycle(%) [20]**

Use the <+> and <-> keys to adjust the minimum CPU fan duty cycle. The values range from 0% to 100%. When the CPU temperature is under 40°C, the CPU fan will operate at the minimum duty cycle.

### 3.6.5 CHA\_FAN1/2/3 Q-Fan Control [Enabled]

[Disabled] Disables the Chassis Q-Fan control feature.

[Enabled] Enables the Chassis Q-Fan control feature.

#### CHA\_FAN1/2/3 Fan Speed Low Limit [600 RPM]

This item appears only when you enable the CHA\_FAN1/2/3 Q-Fan Control feature and allows you to disable or set the CHA\_FAN1/2/3/4 fan warning speed. Configuration options: [Ignore] [200 RPM] [300 RPM] [400 RPM] [500 RPM] [600 RPM]

#### CHA\_FAN1/2/3 Fan Profile [Standard]

This item appears only when you enable the **CHA\_FAN1/2/3 Q-Fan Control** feature and allows you to set the appropriate performance level of the CHA\_FAN1/2/3 fan.

[Standard] Sets to [Standard] to make the chassis fan automatically adjust depending on the chassis temperature.

[Silent] Sets to [Silent] to minimize the fan speed for quiet chassis fan operation.

[Turbo] Sets to [Turbo] to achieve maximum chassis fan speed.

[Manual] Sets to [Manual] to assign detailed fan speed control parameters.



---

The following four items appear only when you set **CHA\_FAN1/2/3/4 Fan Profile** to [Manual].

---

#### CHA\_FAN1/2/3 Upper Temperature [70]

Use the <+> and <-> keys to adjust the upper limit of the chassis temperature. The values range from 40°C to 90°C.

#### CHA\_FAN1/2/3 Fan Max. Duty Cycle(%) [100]

Use the <+> and <-> keys to adjust the maximum chassis fan duty cycle. The values range from 60% to 100%. When the chassis temperature reaches the upper limit, the chassis fan will operate at the maximum duty cycle.

#### CHA\_FAN1/2/3 Lower Temperature [40]

Displays the lower limit of the chassis temperature.

#### CHA\_FAN1/2/3 Fan Min. Duty Cycle(%) [60]

Use the <+> and <-> keys to adjust the minimum chassis fan duty cycle. The values range from 60% to 100%. When the chassis temperature is under 40°C, the chassis fan will operate at the minimum duty cycle.

### 3.6.6 Anti Surge Support [Enabled]

This item allows you to enable or disable the Anti Surge function.

Configuration options: [Disabled] [Enabled]

## 3.7 Boot menu

The Boot menu items allow you to change the system boot options.

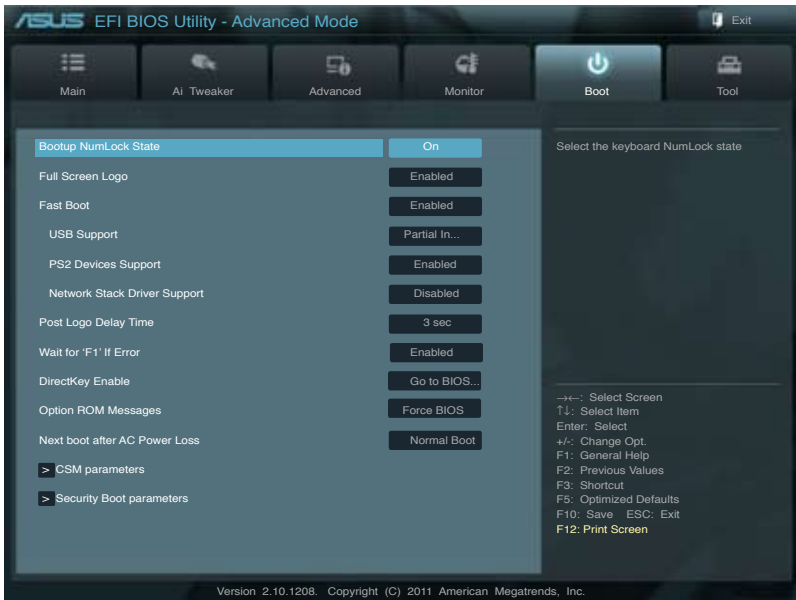

### 3.7.1 Bootup NumLock State [On]

[On] Sets the power-on state of the NumLock to [On].

[Off] Sets the power-on state of the NumLock to [Off].

### 3.7.2 Full Screen Logo [Enabled]

[Enabled] Enables the full screen logo display feature.

[Disabled] Disables the full screen logo display feature.



Set this item to [Enabled] to use the ASUS MyLogo 2™ feature.

### Post Report [5 sec]

This item appears only when the Full Screen Logo item is set to [Disabled] and allows you to set the waiting time for the system to display the post report. Configuration options: [1 sec] [2 sec] [3 sec] [4 sec] [5 sec] [6 sec] [7 sec] [8 sec] [9 sec] [10 sec] [Until Press ESC]

### 3.7.3 Fast Boot [Enabled]

Enables or disables the fast boot function. Configuration options: [Disabled] [Enabled]



The following three items appear when **Fast Boot** is set to [Enabled].

## USB Support [Partial In...]

- [Disabled] All the USB devices will be available only after entering the operating system (OS).
- [Full Initial] All the USB devices will be available during POST and in OS.
- [Partial Initial] Specific USB device / port will be available before entering OS.

## PS2 Devices Support [Enabled]

This item allows you to set the PS/2 devices support. Configuration options: [Auto] [Enabled].

## Network Stack Driver Support [Disabled]

- [Disabled] Disables network stack driver support during POST.
- [Enabled] Enables network stack driver support during POST.

## 3.7.4 Post Logo Delay Time [3 sec]

Allows you to set the Post Logo Delay Time. Configuration options: [0 sec] [1 sec] ~ [10 sec].

## 3.7.5 Wait for 'F1' If Error [Enabled]

When this item is set to [Enabled], the system waits for the F1 key to be pressed when error occurs. Configuration options: [Disabled] [Enabled]

## 3.7.6 DirectKey Enable [Go to BIOS...]

- [Disabled] Disables the DirectKey function.
- [Go to BIOS Setup] Allows the system to power on and go to BIOS setup directly when you press the DirectKey button.

## 3.7.7 Option ROM Messages [Force BIOS]

- [Force BIOS] The third-party ROM messages will be forced to display during the boot sequence.
- [Keep Current] The third-party ROM messages will be displayed only if the third-party manufacturer had set the add-on device to do so.

## 3.7.8 Next boot after AC Power Loss [Normal Boot]

- [Normal Boot] Returns to normal boot up process after AC Power Loss.
- [Fast Boot] Accelerates the boot up speed after AC Power Loss.

## 3.7.9 CSM Parameters

This option allows you to control the CSM launch parameters.

### Launch CSM [Enabled]

Configuration option: [Auto] [Enabled] [Disabled]



---

The following four items appear when **Launch CSM** is set to [Enabled].

---

### Boot option filter [UEFI and L...]

Configuration option: [UEFI and Legacy] [Legacy only] [UEFI only]

### **Launch PXE OpROM policy [DO NOT launch]**

Configuration option: [DO not launch] [Legacy first] [UEFI first]

### **Launch Storage OpROM policy [Legacy only]**

Configuration option: [DO not launch] [Both, Legacy first] [Both, UEFI first] [Legacy first] [UEFI first]

### **Other device ROM priority [Legacy first]**

Configuration option: [UEFI first] [Legacy first]

## **3.7.10 Security Boot parameters**

This option allows you to configure the Security Boot parameters.

### **OS Type [Other Lega...]**

Configuration option: [Windows 8 UEFI] [Other Legacy & UEFI]

### **Secure Boot Mode [Standard]**

This item appears only when you set the **OS Type** to [Windows 8 UEFI]. Configuration option: [Standard] [Custom]



---

The following items appear when **Secure Boot Mode** is set to [Custom].

---

### **Image Execution Policy**

#### ***Internal FV [Always Execute]***

Configuration options: [Always Execute]

#### ***Option ROM [Deny Execute]***

Configuration options: [Always Execute] [Always Deny] [Allow Execute] [Defer Execute] [Deny Execute] [Query Execute]

#### ***Removable Media [Deny Execute]***

Configuration options: [Always Execute] [Always Deny] [Allow Execute] [Defer Execute] [Deny Execute] [Query Execute]

#### ***Fix Media [Deny Execute]***

Configuration options: [Always Execute] [Always Deny] [Allow Execute] [Defer Execute] [Deny Execute] [Query Execute]

### **Key Management**

#### ***Default Key Provisioning [Disabled]***

Configuration options: [Enabled] [Disabled]

#### ***Install default Secure Boot Keys***

Configuration options: [Yes] [No]

#### ***Set PK from File***

Configuration options: [Acpi (a0341d0, 0)\PCI (1212)\USB (2, 0)]

#### ***Get PK to File***

Configuration options: [OK]

#### ***Delete the PK***

Configuration options: [Yes] [No]

#### ***Set KEK from File***

Configuration options: [OK]

#### ***Get KEK to File***

Configuration options: [OK]

**Delete the KEK**

Configuration options: [Yes] [No]

**Append an entry to KEK**

Configuration options: [OK]

**Set DB from File**

Configuration options: [OK]

**Get DB to File**

Configuration options: [OK]

**Delete the DB**

Configuration options: [Yes] [No]

**Append an entry to DB**

Configuration options: [OK]

**Set DBX from File**

Configuration options: [OK]

**Get DBX to File**

Configuration options: [OK]

**Delete the DBX**

Configuration options: [Yes] [No]

**Append an entry to DBX**

Configuration options: [OK]

### 3.7.11 Setup Mode [EZ Mode]

[Advanced Mode] Sets Advanced Mode as the default screen for entering the BIOS setup program.

[EZ Mode] Sets EZ Mode as the default screen for entering the BIOS setup program.

### 3.7.12 Boot Option Priorities

These items specify the boot device priority sequence from the available devices. The number of device items that appears on the screen depends on the number of devices installed in the system.



- 
- To select the boot device during system startup, press <F8> when ASUS Logo appears.
  - To access Windows OS in Safe Mode, press <F8> after POST.
- 

### 3.7.13 Boot Override

These items displays the available devices. The number of device items that appears on the screen depends on the number of devices installed in the system. Click an item to start booting from the selected device.



## 3.8 Tools menu

The Tools menu items allow you to configure options for special functions. Select an item then press <Enter> to display the submenu.



### 3.8.1 ASUS EZ Flash 2 Utility

Allows you to run ASUS EZ Flash 2. Press [Enter] to launch the ASUS EZ Flash 2 screen.



---

For more details, see section 2.1.2 **ASUS EZ Flash 2**.

---

### 3.8.2 ASUS SPD Information

#### DIMM Slot # [DIMM\_A1]

Displays the Serial Presence Detect (SPD) information of the DIMM module installed on the selected slot. Configuration options: [DIMM\_A1] [DIMM\_A2] [DIMM\_B1] [DIMM\_B2]

### 3.8.3 ASUS O.C. Profile

This item allows you to store or load multiple BIOS settings.



---

The **Setup Profile Status** items show **Not Installed** if no profile is created.

---

#### Save to Profile

Allows you to save the current BIOS settings to the BIOS Flash, and create a profile. Key in a profile number from one to eight, press <Enter>, and then select **Yes**.

#### Load from Profile

Allows you to load the previous BIOS settings saved in the BIOS Flash. Key in the profile number that saved your CMOS settings, press <Enter>, and then select **Yes**.



- 
- DO NOT shut down or reset the system while updating the BIOS to prevent the system boot failure!
  - We recommend that you update the BIOS file only coming from the same memory/ CPU configuration and BIOS version.
-

## 3.9 Exit menu

The Exit menu items allow you to load the optimal default values for the BIOS items, and save or discard your changes to the BIOS items. You can access the **EZ Mode** from the Exit menu.



### Load Optimized Defaults

This option allows you to load the default values for each of the parameters on the Setup menu. When you select this option or if you press <F5>, a confirmation window appears. Select Yes to load the default values.

### Save Changes & Reset

Once you are finished making your selections, choose this option from the Exit menu to ensure the values you selected are saved. When you select this option or if you press <F10>, a confirmation window appears. Select Yes to save changes and exit.

### Discard Changes & Exit

This option allows you to exit the Setup program without saving your changes. When you select this option or if you press <Esc>, a confirmation window appears. Select Yes to discard changes and exit.

### ASUS EZ Mode

This option allows you to enter the EZ Mode screen.

### Launch EFI Shell from filesystem device

This option allows you to attempt to launch the UEFI Shell application (shellx64.efi) from one of the available devices that have a filesystem.

# Software support

# 4

## 4.1 Installing an operating system



- This motherboard supports Windows® XP/ Vista / 64-bit Vista / 7 / 8 / 64-bit 7 / 8 operating systems (OS).
- Motherboard settings and hardware options vary. Use the setup procedures presented in this chapter for reference only. Refer to your OS documentation for detailed information.
- Ensure that you install the Windows® XP Service Pack 3 or later versions before installing the drivers for better compatibility and system stability.

## 4.2 Support DVD information



The contents of the support DVD are subject to change at any time without notice. Visit the ASUS website at [www.asus.com](http://www.asus.com) for updates.

### 4.2.1 Running the support DVD

Place the support DVD into the optical drive. The DVD automatically displays the Drivers menu if Autorun is enabled in your computer. Click each menu tab and select the items you want to install.

The Drivers menu shows the available device drivers if the system detects installed devices. Install the necessary drivers to use the devices.

The Make Disk menu contains items to create the RAID/AHCI driver disk.

The Manual menu contains the list of supplementary user manuals. Click an item to open the folder of the user manual.

The Utilities menu shows the applications and other software that the motherboard supports.

Click an item to install



Click the Contact tab to display the ASUS contact information.

Click an icon to display DVD/ motherboard information



If Autorun is NOT enabled in your computer, browse the contents of the support DVD to locate the file ASSETUP.EXE from the BIN folder. Double-click the ASSETUP.EXE to run the DVD.

## 4.2.2 Obtaining the software manuals

The software manuals are included in the support DVD. Follow the instructions below to get the necessary software manuals.



The software manual files are in Portable Document Format (PDF). Install the Adobe® Acrobat® Reader from the Utilities menu before opening the files.

1. Click the **Manual** tab. Click **ASUS Motherboard Utility Guide** from the manual list on the left.



2. The **Manual** folder of the support DVD appears. Double-click the folder of your selected software.

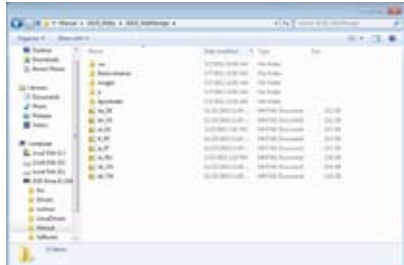

3. Some software manuals are provided in different languages. Double-click the language to show the software manual.

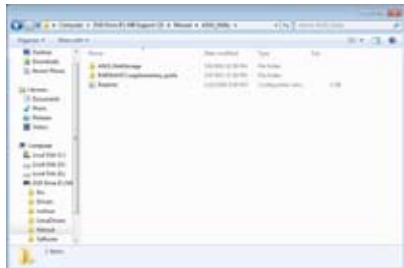

The screenshots in this section are for reference only. The actual software manuals containing in the support DVD vary by models.

## 4.3 Software information

Most of the applications in the support DVD have wizards that will conveniently guide you through the installation. View the online help or readme file that came with the software application for more information.

### 4.3.1 AI Suite II

AI Suite II is an all-in-one interface that integrates several ASUS utilities and allows users to launch and operate these utilities simultaneously.

#### Installing AI Suite II

To install AI Suite II on your computer:

1. Place the support DVD to the optical drive. The Drivers installation tab appears if your computer has enabled the Autorun feature.
2. Click **Utilities** tab > **AI Suite II**.
3. Follow the onscreen instructions to complete the installation.

#### Using AI Suite II

AI Suite II automatically starts when you enter the Windows® operating system (OS). The AI Suite II icon appears in the Windows® notification area. Click the icon to open the AI Suite II main menu bar.

Click each button to select and launch a utility, to monitor the system, to update the motherboard BIOS, to display the system information, and to customize the settings of AI Suite II.

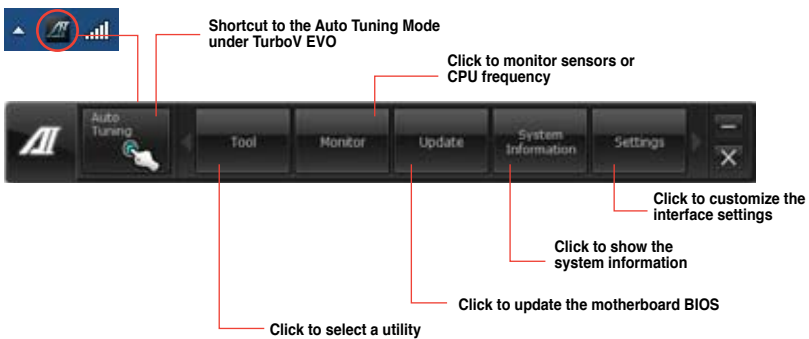

- The **Auto Tuning** button appears only on models with the TurboV EVO function.
- The applications in the Tool menu vary with motherboard models and CPUs installed.
- The screenshots of AI Suite II in this user manual are for reference only. The actual screenshots vary with models.
- Refer to the software manual in the support DVD or visit the ASUS website at [www.asus.com](http://www.asus.com) for detailed software configuration.

### 4.3.2 TurboV EVO

ASUS TurboV EVO introduces **TurboV** that allows you to manually adjust the APU frequency and related voltages as well as **Auto Tuning** function that offers automatic and easy overlocking and system level up. After installing AI Suite II from the motherboard support DVD, launch TurboV EVO by clicking **Tool > TurboV EVO** on the AI Suite II main menu bar



Refer to the software manual in the support DVD or visit the ASUS website at [www.asus.com](http://www.asus.com) for detailed software configuration.

#### TurboV

TurboV allows you to overclock the APU frequency, CPU voltage, VDDNB voltage, DRAM Voltage, SB 1.1V Voltage, and APU 1.2V Voltage in Windows® environment and takes effect in real-time without exiting and rebooting the OS.



Refer to the CPU documentation before adjusting CPU voltage settings. Setting a high voltage may damage the CPU permanently, and setting a low voltage may make the system unstable.



For system stability, all changes made in **TurboV** will not be saved to BIOS settings and will not be kept on the next system boot. Use the **Save Profile** function to save your customized overclocking settings and manually load the profile after Windows starts.

The screenshot shows the ASUS TurboV EVO interface with the following callouts:

- Click to select Mode
- Load profile
- Target values
- Current values
- Click to show settings
- Click to restore all start-up settings
- Save the current settings as a new profile
- Voltage Adjustment bars
- Undoes all changes without applying
- Applies all changes immediately

Parameter	Current Value	Target Value
APU Frequency	180	180
CPU Voltage	1.2075V	1.2075V
VDDNB Voltage	1.2000V	1.2000V
DRAM Voltage	1.50	1.50

## Using Advanced Mode

Click on the **Advanced Mode** tab to adjust the advanced voltage settings.



## GPU Boost

GPU Boost overlocks the integrated iGPU for the best graphics performance.

1. Click on the GPU Boost tab.
2. Adjust the GPU Boost settings.
3. Click **Yes** for the changes to take effect.



AMD A10-5800K, A8-5600K, A6-5400K, and all upcoming Black Edition APUs support GPU overlocking.

## APU Multiplier

Allows you to manually adjust the APU Multiplier.

1. Click on the APU Multiplier tab.
2. Drag the adjustment bar leftwards or rightwards to the desired value.
3. Click **Apply** for the changes to take effect.

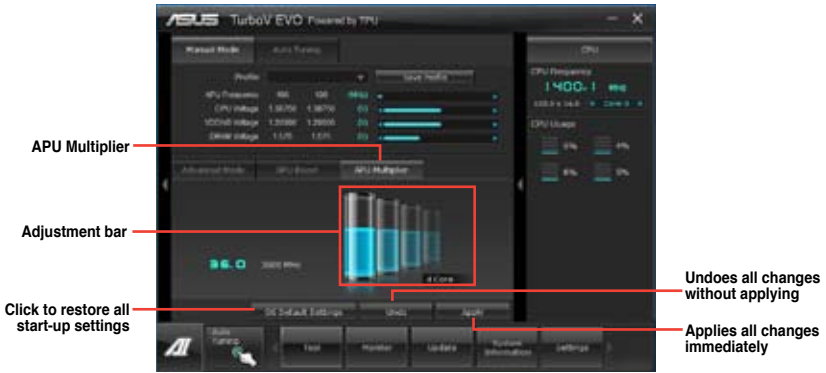

- Set the **APU Multiplier** item in BIOS to [Auto] before using the APU Multiplier function in TurboV. Refer to the BIOS section of your motherboard user manual for details.
- The APU Multiplier bars show the status of the APU cores, which vary with your APU model.



## Auto Tuning

ASUS TurboV EVO includes two auto tuning modes, providing the most flexible auto-tuning options.



- The overclocking result varies with the CPU model and the system configuration.
- To prevent overheating from damaging the motherboard, a better thermal environment is strongly recommended.

- **Fast Tuning:** fast CPU overclocking
- **Extreme Tuning:** extreme overclocking for CPU and memory

### Using Fast Tuning

1. Click the Auto Tuning tab and then click **Fast**.
2. Read through the warning messages and click **OK** to start auto-overclocking.
3. TurboV automatically overclocks the CPU, saves BIOS settings and restarts the system. After re-entering Windows, a message appears indicating auto tuning success. Click **OK** to exit.



### Using Extreme Tuning

1. Click the **Auto Tuning** tab and then click **Extreme**.
2. Read through the warning messages and click **OK** to start auto-overclocking.



3. TurboV automatically overlocks the CPU and memory and restarts the system. After re-entering Windows, a message appears indicating the current overclocking result. To keep the result, click **Stop**.



4. If you did not click **Stop** in the previous step, TurboV automatically starts further system overclocking and stability test. An animation appears indicating the overclocking process. Click **Stop** if you want to cancel the Overclocking process.



5. TurboV automatically adjusts and saves BIOS settings and restarts the system. After re-entering Windows, a message appears indicating auto tuning success. Click **OK** to exit.



### 4.3.3 DIGI+ VRM

ASUS DIGI+ VRM allows you to adjust VRM voltage and frequency modulation to enhance reliability and stability. It also provides the highest power efficiency, generating less heat to longer component lifespan and minimize power loss.

To launch DIGI+VRM, click **Tool > DIGI+ VRM** on the AI Suite II main menu bar.

#### CPU Power



Items	Function description
1	<b>CPU Load-line Calibration</b> It allows you to adjust the voltage range to control CPU Load Line. Set to a high value for system performance or to a low value for power efficiency.
2	<b>CPU Current Capability</b> A higher value provides wider total power range and extends the overclocking frequency range simultaneously.
3	<b>CPU Voltage Frequency</b> It allows you to enable Spread Spectrum to enhance system stability.
4	<b>CPU/NB Load Line Calibration</b> CPU/NB Load-line controls the behavior of the DRAM controller. Set to a high value for better system performance or to a better thermal solution.
5	<b>CPU/NB Current Capability</b> A higher value brings higher DRAM controller power range, and extends the overclocking frequency range simultaneously.

Items	Function description
6	<b>CPU Power Phase Control</b> Increase phase number under heavy system loading to get more transient and better thermal performance. Reduce phase number under light system loading to increase VRM efficiency.



- 
- The actual performance boost may vary depending on your CPU specification.
  - Do not remove the thermal module. The thermal conditions should be monitored.
- 



---

Refer to the software manual in the support DVD or visit the ASUS website at [www.asus.com](http://www.asus.com) for detailed software configuration.

---

### 4.3.4 EPU

EPU is an energy-processing utility that provides several power-saving modes. When set to the Auto Mode, the system automatically changes its power-saving mode based on the current system condition.

You can also configure the system settings such as CPU frequency, GPU frequency, vCore Voltage, and Fan Control to customize a power-saving mode.

#### Launching EPU

To launch EPU, click **Tool > EPU** on the AI Suite II main menu bar.

The screenshot shows the ASUS EPU interface. At the top, there are three modes: 'Auto', 'High performance', and 'Max. power saving'. The 'Auto' mode is selected. Below the modes is a central pentagonal gauge with five segments labeled 'Transparency', 'Performance', 'Reliability', 'Energy saved', and 'Connectivity'. To the right, there is an 'EPU Status' window showing 'Reduced CO2 Emission: 0.000 mg', 'Time Started: since 2010/02/28/12', and 'Current CPU Power: 0.00 Watts'. At the bottom, there are buttons for 'Auto Tuning', 'Load', 'Monitor', 'Update', 'System Information', and 'Settings'.

Multiple system operating modes

Displays the following message if no VGA power saving engine is detected.

The items lighting up means power saving engine is activated

Displays the amount of CO2 reduced

\*Shifts between the display of Total and Current CO2 reduced

Displays the current CPU power

Advanced settings for each mode

Displays the system properties of each mode



- Select From EPU Installation to show the CO2 that has been reduced since you installed EPU.
- \*Select **From the Last Reset** to show the total CO2 that has been reduced since you click the Clear button .
- Refer to the software manual in the support DVD or visit the ASUS website at [www.asus.com](http://www.asus.com) for detailed software configuration.

## 4.3.5 FAN Xpert 2

FAN Xpert 2 automatically detects and tweaks all fan speeds, and provides you with optimized fan settings based on the fans' specifications and positions.

### Launching FAN Xpert 2

To launch FAN Xpert 2, click **Tool > FAN Xpert 2** from the AI Suite menu bar.

### Using FAN Xpert 2 Auto Tuning

FAN Xpert 2's **Fan Auto Tuning** feature automatically detects the fans and their locations to provide you with optimized fan settings.

#### To use Fan Auto Tuning:

1. Click **Fan Auto Tuning** on the FAN Xpert 2 main menu.



2. Wait for the **Fan Auto Tuning Process** to complete, then click **Next**.



Do not remove your fan during the Fan Auto Tuning process.

- From the **Fan Position** screen, check and assign the locations of your fans, then click **OK** to exit the screen.



If CPU or chassis fans have been changed, the Fan Auto Tuning process should be repeated.

- Select any of these fan customized settings for each fan:
  - Silent:** Minimized fan speed for silent fan operation.
  - Standard:** Balanced configuration between noise level and fan speed.
  - Turbo:** High fan speed for high cooling capability.
  - Full Speed:** Maximum fan speed.



Select one customized setting

## Advanced Mode

FAN Xpert 2's Advanced Mode button  allows you to adjust the reaction speed for fan rotation based on the system's temperature and to configure the fan's rotation per minute.



## Smart Mode

The Smart Mode allows you to adjust the reaction speed for fan rotation based on the system's temperature.

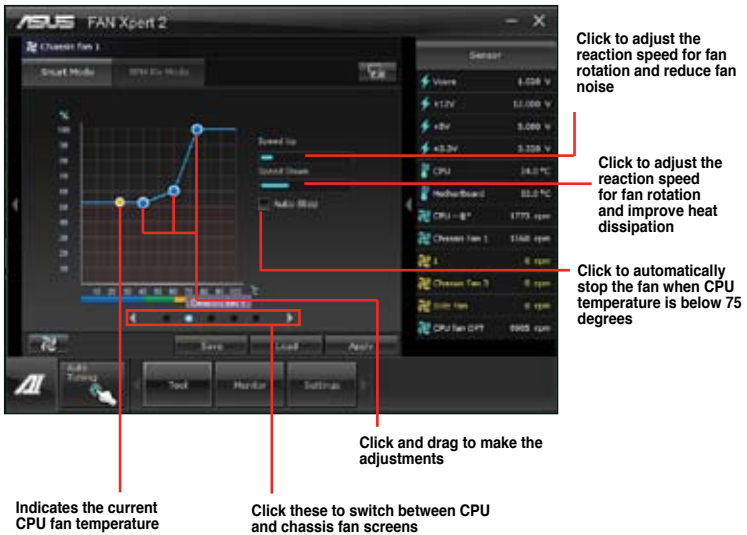



## RPM Fixed Mode

The RPM Fixed Mode tab allows you to set your fan speed when CPU temperature is below 75 degrees.





Click and drag to make the adjustments

Click to switch between CPU fan window and chassis fan windows 1 to 4



- To protect your CPU, the fan will not automatically turn off even if you set the CPU fan power to 0.
- Only 4-pin CPU fans and 4-pin and 3-pin chassis fans are compatible with FAN Xpert 2.
- FAN Xpert 2 may not be able to detect your fan speed if your fan has an external control kit for rotation speed.
- 2-pin fans are only allowed to run at full speed.

## Fan Information

Click the Fan Information button  to see the details of each detected fan. You can click on either the table button  or the graph button  to see the results.



Click to see the results in table format

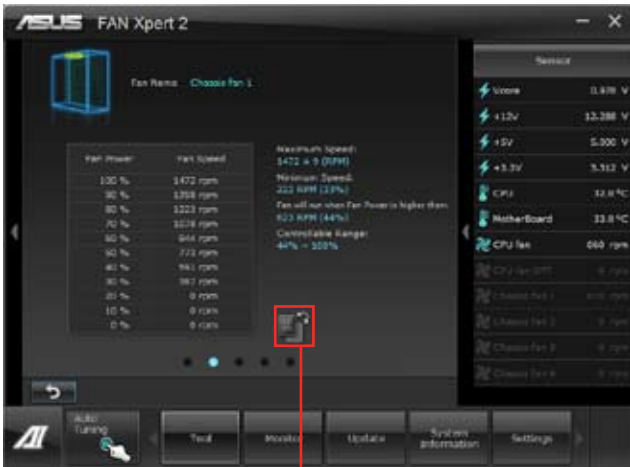

Click to see the results in graph format

### 4.3.6 USB Charger+

This utility allows you to fast-charge your portable USB devices even if your PC is off, in Sleep Mode, or Hibernate Mode.

#### Launching the USB Charger+

To launch this utility, open the **AI Suite II**, then click **Tool > USB Charger+**.



\* The illustration above shows that there is no device connected to your PC for fast-charging.

#### USB fast-charging mode settings

Click the dropdown box, and select a proper charge mode when your PC is off, in Sleep Mode, or Hibernate Mode.

- **Disable:** disables the USB fast-charging function.
- **ASUS:** fast-charges your connected ASUS devices.
- **Apple:** fast-charges your connected Apple devices.
- **Kindle:** fast-charges your Kindle devices.
- **Others:** charges other portable USB devices.



The utility cannot detect the devices connected to your computer if the charging mode is enabled.



## Setting up the charging function

When a portable device is connected to the USB port of the PC, the USB Charger+ automatically detects the kind of your device.

### Charging the device

Click  to fast-charge your device.



Clicking the  stops the charging of your connected device, and rescans for other detected devices. Click the  to re-enable the fast-charging.

## Disabling the charging function

Click  to stop charging your device.



## 4.3.7 USB 3.0 Boost

ASUS USB 3.0 Boost technology supports UASP (USB Attached SCSI Protocol) and automatically increases a USB 3.0 device's transfer speed up to 170%.

### Launching USB 3.0 Boost

To launch USB 3.0 Boost, click **Tool > USB 3.0 Boost** on the AI Suite II main menu bar.

### Configuring USB 3.0 Boost

1. Connect a USB 3.0 device to the USB 3.0 port.

USB 3.0 Boost automatically detects the property of the USB 3.0 device and switches to Turbo mode or UASP mode (if UASP is supported by the USB 3.0 device).

2. You can manually switch the USB 3.0 mode back to Normal mode at any time.



- Refer to the software manual in the support DVD or visit the ASUS website at [www.asus.com](http://www.asus.com) for detailed software configuration.
- Use the USB 3.0 devices for high performance. The data transfer speed varies with USB devices.

## 4.3.8 USB BIOS Flashback Wizard

USB BIOS Flashback allows you to easily update the BIOS without entering the BIOS or operating system. Just connect the USB storage device containing the BIOS file to the USB port, press the BIOS Flashback button, and the BIOS is updated automatically.

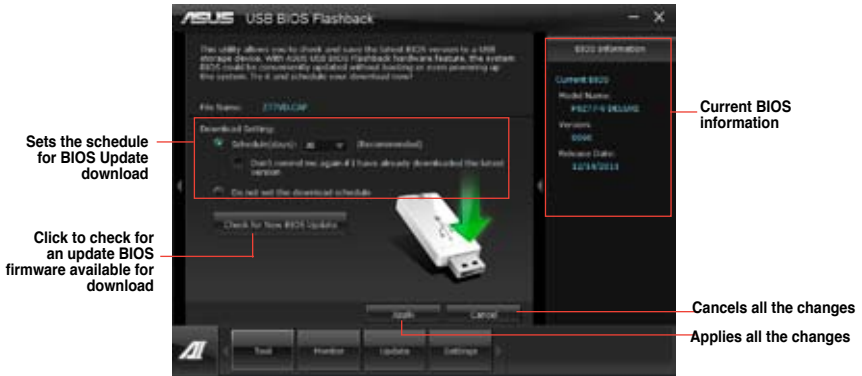

### Scheduling the latest BIOS download

1. In the Download Setting field, tick **Schedule (days)** and select the number of days for your download schedule.
2. Click **Apply** to save the BIOS download schedule. Click Cancel to cancel the changes made.

### Downloading the updated BIOS



Before you start downloading, ensure that you have installed the USB storage device to your computer's USB port.

### Scheduling the latest BIOS download

1. In the Download Setting field, tick **Schedule (days)** and select the number of days for your download schedule.
2. Click **Apply** to save the BIOS download schedule. Click Cancel to cancel the changes made.

## Downloading the updated BIOS

1. Click **Check for New BIOS Update** to check for the latest BIOS version.

Wait for the system to check the latest BIOS firmware.

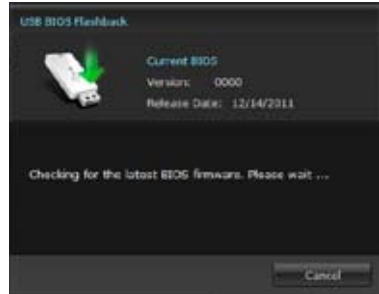

2. After the utility detects a new BIOS firmware, click  from the **Save to** field to save the BIOS firmware, select the USB flashdrive, and click **Download**.

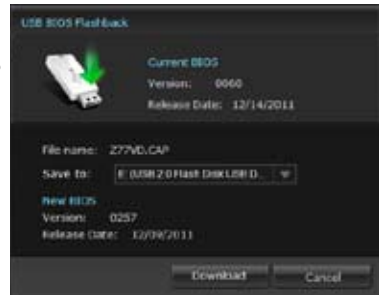

3. After the download is complete, click **OK**.



### 4.3.9 Ai Charger+

This utility allows you to fast-charge your portable BC 1.1\* mobile devices on your computer's USB port three times faster than the standard USB devices\*\*.



- \* Check your manufacturer if your USB device is a Battery Charging Specification 1.1 (BC 1.1) compliant or compatible device.
- \*\* Actual charging speeds may vary depending on the charging rate and specifications of your USB device.
- To ensure normal charging function, disconnect and reconnect your USB device every time you enable or disable Ai Charger+.





### 4.3.10 Probe II

Probe II is a utility that monitors the computer's vital components, and detects and alerts you of any problem with these components. Probe II senses fan rotations, CPU temperature, and system voltages, among others. With this utility, you are assured that your computer is always at a healthy operating condition.

#### Launching Probe II

To launch Probe II, click **Tool > Probe II** on the AI Suite II main menu bar.

#### Configuring Probe II

Click the Voltage/Temperature/Fan Speed tabs to activate the sensors or to adjust the sensor threshold values. The Preference tab allows you to customize the time interval of sensor alerts, or change the temperature unit.

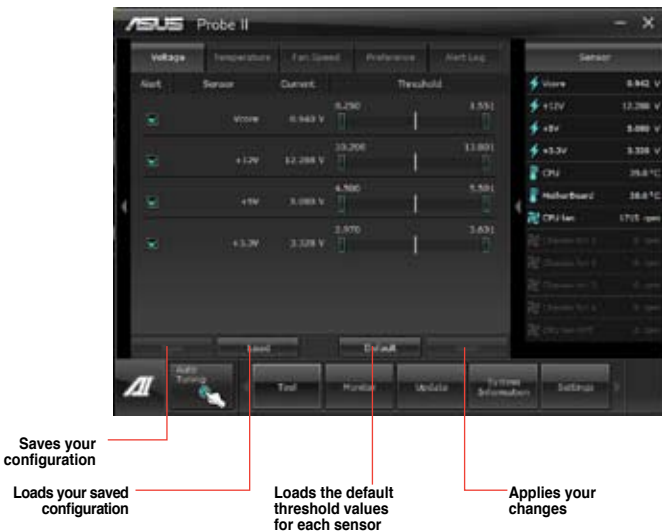

- Click **Monitor > Sensor** on the AI Suite II main menu bar and the system status will appear on the right panel.
- Refer to the software manual in the support DVD or visit the ASUS website at [www.asus.com](http://www.asus.com) for detailed software configuration.

### 4.3.11 Sensor Recorder

Sensor Recorder monitors the changes in the system voltage, temperature, and fan speed on a timeline. The History Record function allows you to designate specific time spans on record to keep track of the three system statuses for certain purposes.

#### Launching Sensor Recorder

To launch Sensor Recorder, click **Tool > Sensor Recorder** on the AI Suite II main menu bar.

#### Using Sensor Recorder

Click on Voltage/ Temperature/ Fan Speed tabs for the status you want to monitor. Colored lines will automatically appear on the diagram to indicate the immediate changes in the system status.



## Using History Record

1. Click the **History Record** tab and adjust the settings on the left for **Record Interval** and **Record Duration**.
2. Click **Start Recording** to start measuring and recording each sensor.
3. To stop recording, click **Recording** again.
4. To track the recorded contents, set Type/ Date/ Select display items to display the history details.

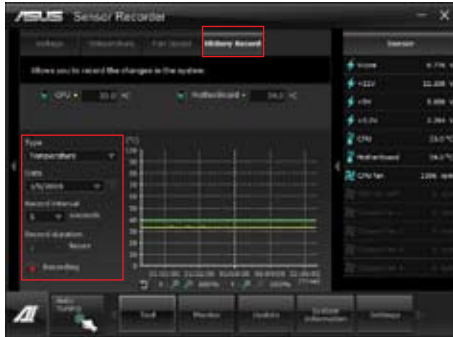

---

Click **Monitor > Sensor** on the AI Suite II main menu bar and a highlight of the system statuses will appear on the right panel.

---

### 4.3.12 ASUS Update

ASUS Update is a utility that allows you to manage, save, and update the motherboard BIOS in Windows® environment.

#### Launching ASUS Update

To launch ASUS Update, click **Update > ASUS Update** on the AI Suite II main menu bar.

#### Using ASUS Update

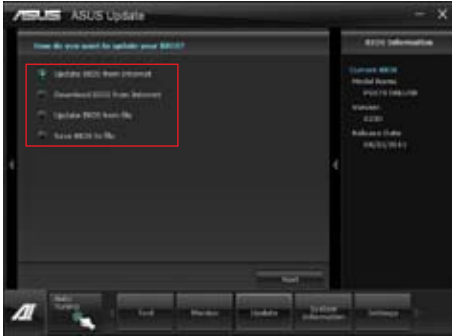

Select any of these options to update the BIOS:

- **Update BIOS from Internet**  
Allows you to download the latest BIOS version from the ASUS website at [www.asus.com](http://www.asus.com) and follow the onscreen instructions to update the BIOS.
- **Download BIOS from Internet**  
Download the latest BIOS version from the ASUS website at [www.asus.com](http://www.asus.com) and save it for later use.
- **Update BIOS from file**  
Use the BIOS file that you had downloaded and saved to update the system BIOS.
- **Save BIOS to file**  
Save the BIOS file to another file or a USB storage device for later use.

### 4.3.13 MyLogo2

MyLogo2 allows you to customize the boot logo, which is the image that appears on the screen during the Power On Self Tests (POST).

#### Launching ASUS Update

To launch MyLogo2, click **Update > MyLogo** on the AI Suite II main menu bar.

#### Using MyLogo



Select the option that you want to use to update your boot logo, click **Next** and follow the instructions below.

Change the boot logo of a downloaded BIOS file and update (or do not update) this BIOS to the motherboard

1. From the **BIOS file** field, click **Browse** to locate the BIOS file.
2. From the **Picture File** field, click **Browse** the image for your boot logo, then click **Next**.



3. Do any of the following:
  - Click **Auto Tune** to adjust the image size or the image resolution.
  - Click **Booting Preview** to preview the boot image.
4. Click **Next**.



5. Click **Flash** to update the boot logo.
6. When prompted, click **Yes** to reboot the system. You will see the new boot logo the next time you start up the system.



---

Ensure to enable the **Full Screen Logo** in BIOS to use this feature.

---

### 4.3.14 Audio configurations

The Realtek® audio CODEC provides 8-channel audio capability to deliver the ultimate audio experience on your computer. The software provides Jack-Sensing function, S/PDIF Out support, and interrupt capability. The CODEC also includes the Realtek® proprietary UAJ® (Universal Audio Jack) technology for all audio ports, eliminating cable connection errors, and giving users plug and play convenience.

Follow the installation wizard to install the Realtek® Audio Driver from the support DVD that came with the motherboard package.

If the Realtek® audio software is correctly installed, you will find the Realtek® HD Audio Manager icon on the taskbar. Double-click on the icon to display the Realtek HD Audio Manager.



## A. Realtek HD Audio Manager for Windows® 7



## B. Realtek HD Audio Manager for Windows® XP



- Refer to the software manual in the support DVD or visit the ASUS website at [www.asus.com](http://www.asus.com) for detailed software configuration.
- To play Blu-Ray disc, make sure to use an HDCP compliant monitor.

### 4.3.15 Network iControl

ASUS Network iControl, a one-stop setup network control center that gives you the EZ Start, Quick Connection, and EZ Profile functions, makes it easier for you to manage your network bandwidth. It also allows you to automatically connect to a PPPoE network for a more convenient online experience.

To launch Network iControl, click **Tool > Network iControl** from AI Suite II main menu bar.



- Ensure to install the LAN drivers before using this function.
- Network iControl is only supported under Windows 7 / 8 and can only support the onboard LAN.

#### Using EZ Start

EZ Start allows you to quickly activate Network iControl, and set the highest bandwidth priority for your top currently running program.

To use EZ Start:

1. Click the **EZ Start** tab.
2. Click **ON/OFF** to enable/disable Network iControl.



- By default, Network iControl is set to ON.
- When switched off, the **Quick Connection**, **EZ Profile** and **Info** are disabled.
- You may monitor the bandwidth priority from your desktop's taskbar.

3. Tick **Set current network program as the highest priority** to enable **User Profile**.
4. Select a profile and click **Apply**.



You may also apply your personal profile in **EZ Start**.

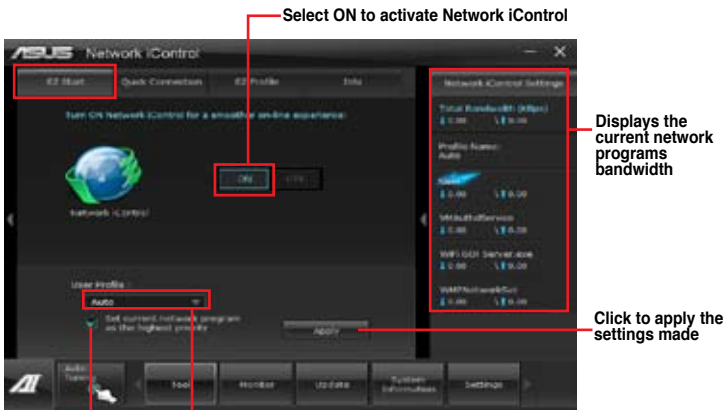

Click to enable the network program as the highest priority

Click to select a profile



## Using Quick Connection

### Configuring the PPPoE connection settings

Before enabling the Network iControl's **Quick Connection** functions, you must configure the PPPoE connection settings

#### To configure the PPPoE settings:

1. Right-click  in the taskbar, and select **Open Network and Sharing Center**.

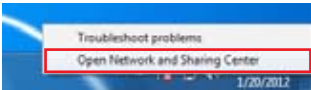

2. Right-click the PPPoE Connection, and select **Properties**.



3. Click the **Options** tab, and deselect **Prompt for name and password, certificate, etc.** Click **OK** to complete the auto PPPoE connection settings.



- You only need to configure the PPPoE connection settings once.
- Obtain the necessary information about your PPPoE connection from your network provider.

## Configuring the Quick Connection

To configure the auto-PPPoE connection:

1. Click the **Quick Connection** tab.
2. Tick **Automatically connect online anytime** option, then select the connection name in the **Connection Name** dropdown box.
3. Click **Apply** to enable PPPoE automatic network connection.





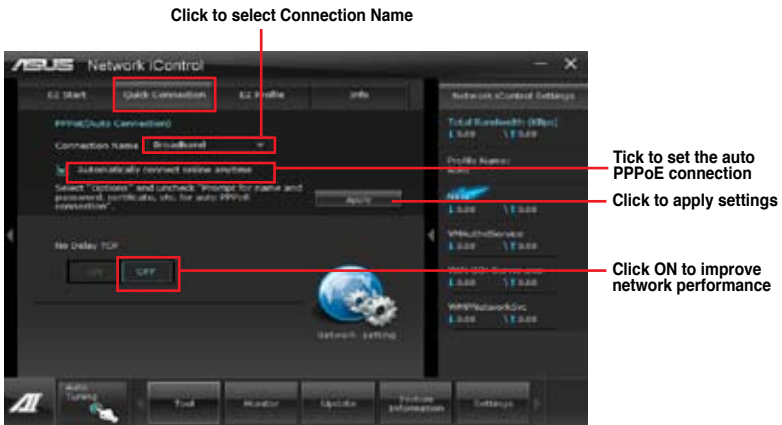

You can also enable the **No Delay TCP** function to help improve the network performance.



## Using EZ Profile

### To use the EZ Profile:

EZ Profile allows you to load, edit, and save your own network program priority profile.

1. Click the **EZ Profile** tab. The running programs are shown in the network program column.
2. Select the network program, and click  to create your profile.
3. Click  to save the changes and/or rename your profile.
4. Click , , or  to set the program priority as High, Normal, or Low.

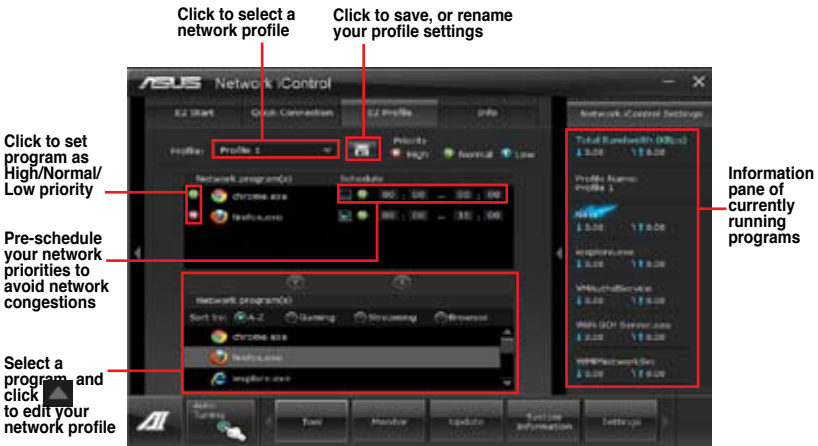

### 4.3.16 Remote GO!

Connect your computer to a wireless network and use Remote GO! to wirelessly stream media files to DLNA devices. It allows you to remotely control and access your computer using your mobile device, and easily transfer files between your computer and mobile device.



- Remote GO! is supported only on Windows® 7 / 8.
- All devices using the Remote GO! functions must be in the same network.

#### Using Remote GO!

To launch Remote GO!, click **Tool > Remote GO!** on the AI Suite II menu bar.



#### Remote GO! functions

- **DLNA Media Hub:** Provides support to the latest DLNA standard, and allows you to stream media files to a DLNA-supported device.
- **Remote Desktop:** Allows you to view your computer's desktop and remotely operate your computer in real-time from your mobile device.
- **File Transfer:** Allows you to transfer files between your computer and mobile device.



Launch W-Fi GO! Remote on your mobile device to use W-Fi GO! Remote control functions. For more details, refer to next section W-Fi GO! Remote.

## W-Fi GO! Remote

Install the W-Fi GO! Remote application on your mobile device to use Remote GO!’s remote control functions.

- 
- Wi-Fi GO! Remote supports iOS 4.0/Android 2.3 mobile devices or later versions.
  - For iOS devices, download the W-Fi GO! Remote from iTunes store. For Android devices, download the W-Fi GO! Remote from Google Play Store or from ASUS support DVD.
- 

## Launching W-Fi GO! Remote

1. Turn on your mobile device’s wireless connection. Ensure that your mobile device is within the same network as your computer.
2. On your mobile device, tap  and tap **Enter** on the W-Fi GO! Remote page.
3. Tap the computer you want to connect to your mobile device.
4. Tap the computer you want to connect to your mobile device.



## W-Fi GO! Remote menu

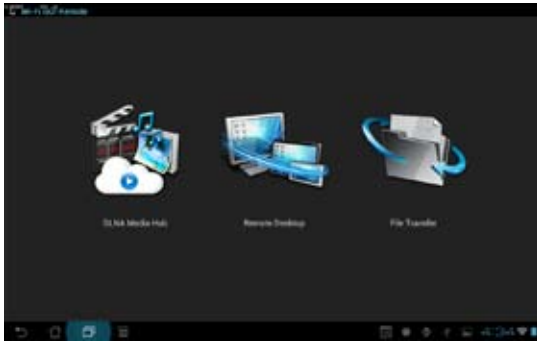

The W-Fi GO! Remote's user interface shown above is for reference only and may vary with the mobile device's operating system.

Below are the supported screen resolution of your mobile devices:

Screen type	Low Density (120, ldpi)	Medium Density (160, mdpi)	High Density (240, hdpi)	Extra high density (320, xhdpi)
Small creen	QVGA (240 x 320)		480 x 640	
Normal screen	WQVGA400 (240 x 400)	HVGA (320 x 480)	WVGA800 (480 x 800)	640 x 960
	WQVGA432 (240 x 432)		WVGA854 (480 x 854) 600 x 1024	
Large screen	WVGA800 (480 x 800)	WVGA800 (480 x 800)		
	WVGA854 (480 x 854)	WVGA854 (480 x 854) 600 x 1024		
Extra large screen		WXGA (1280 x 800)	1536 x 1152	2048 x 1536
	1024 x 600	1024 x 768	1920 x 1152	2560 x 1536
		1280 x 768	1920 x 1200	2560 x 1600

## DLNA Media Hub

DLNA Media Hub allows you to stream your multimedia files to your DLNA-supported device and remotely control playback using your mobile device or your computer.

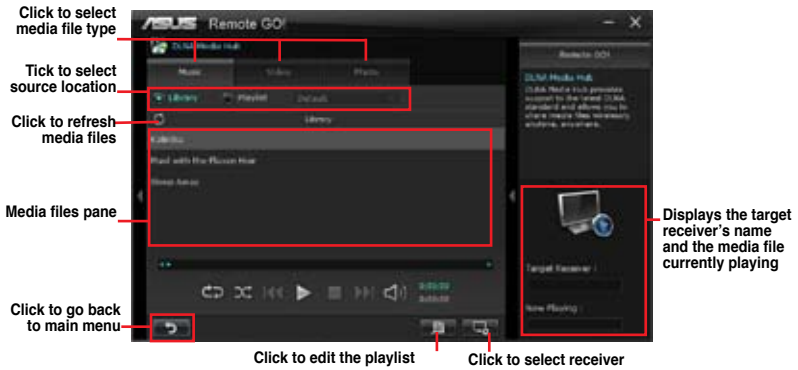

## Using the DLNA Media Hub

1. From the main screen, click **DLNA Media Hub**.
2. Click  to select a device as your receiver.
  - When using your DLNA display (such as DLNA TV) as the receiver, ensure that DLNA function is enabled.
  - When using another computer as the receiver, launch **Windows Media Player**, click **Stream > Allow remote control of my Player** to remotely control media playback.

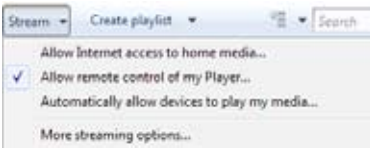

- When using the computer as sender and receiver, launch **Windows Media Player**, click **Stream > Allow remote control of my Player** and **Automatically allow devices to play my media**.

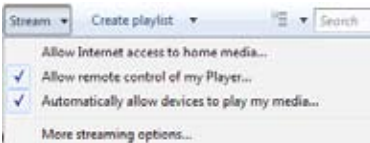



- Only computers under Windows® 7/8 support the DLNA Media Hub function.
- Keep the Windows Media Player open. Ensure that your media file formats supported on Windows Media Player and DLNA playback devices.

3. Click any of the tabs to select your preferred media file type.

## Playing music

### To play music:

1. Click **Music** tab.
2. Tick **Library** to view or play files.  
Tick **Playlist** and select an existing playlist from the dropdown list.
3. Click a music file, and click



## Editing the library

### To edit the library:

1. Tick **Library**.
2. Click to add or delete music files.
3. Click **Add** and locate the file from the directory. To delete, tick the selected file and click **Delete**.
4. Click **OK**.



## Editing the music playlist

### To edit the music playlist:

1. Tick **Playlist**.
2. Click .
3. Tick to select or deselect the music file and click **Save Profile**.
4. Select the profile name and click **Save**. To add as a new playlist, key in your profile name and click **Save**.
5. To delete the playlist, select the profile and click .





## Playing a video file

### To play a video file:

1. Click **Video** tab.
2. Tick **Library** to view the video files from your local computer. Tick **Playlist** to view the video files saved in your profile.
3. Click the video file you want to watch, and click .

Change the resolution from the **Quality** dropdown list.

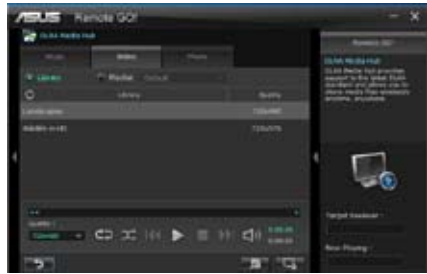

## Editing the video library

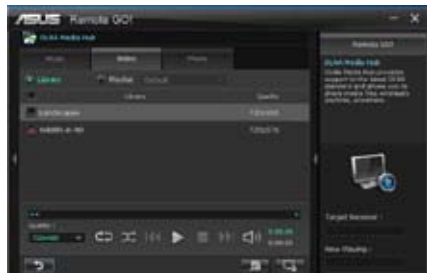

### To edit the video library:

1. Tick **Library**.
2. Click  to add or delete video files.
3. Click **Add** and locate the file from the directory. To delete, tick the selected file and click **Delete**.
4. Click **OK**.



## Editing the video playlist

### To edit the video playlist:

1. Tick **Playlist**.
2. Click .
3. Tick to select or deselect the video file and click **Save Profile**.
4. Select the profile name and click **Save**. To add as a new playlist, key in your profile name and click **Save**.
5. To delete playlist, select the profile and click .



## Viewing the images

To view the images:

1. Click **Photo** tab.
2. Tick **Library** to view the image files from your local computer. Tick **Playlist** to view the image files saved in your profile.

An image slideshow plays when pressing .



## Editing the image library



To edit the image library:

1. Tick **Library**.
2. Click  to add or delete image files.
3. Click **Add** and locate the file from the directory. To delete, tick the selected file and click **Delete**.
4. Click **OK**.



## Editing the image playlist

To edit the image playlist:

1. Tick **Playlist**.
2. Click .
3. Tick to select or deselect the image file and click **Save Profile**.
4. Select the profile name and click **Save**. To add as a new playlist, key in your profile name and click **Save**.
5. To delete playlist, select the profile and click .



## Using the DLNA Media Hub via W-Fi GO! Remote

You can access the DLNA Media Hub on your mobile device via W-Fi GO! Remote.

1. Tap **DLNA Media Hub**.
2. Select and tap the receiver name.



3. The mobile device shows the information of the DLNA Media Hub function. Tap **Enter** to proceed to the Remote GO! function.
4. Tap **Music**, **Video** or **Photo**, to play.



Your mobile device's W-Fi GO! Remote interface may vary with the mobile device's operating system.

## Remote Desktop

Remote Desktop allows you to view your computer's desktop and remotely operate your computer in real-time from your mobile device.

### Using the Remote Desktop

1. From the main screen, click **Remote Desktop**.
2. Click **Setting**.



3. Select a suitable codec **Auto**, **Speed optimization**, or **Image optimization** for your mobile device.
4. Click **Apply**.



## Using the Remote Desktop via W-Fi GO! Remote

When the **Remote Desktop** is enabled, the mobile device shows the contents of your desktop.



The W-Fi GO! Remote's user interface shown above is for reference only and may vary with the mobile device's operating system.

## File Transfer

Allows you to transfer files wirelessly between your computer and mobile device.



Before using File Transfer, ensure that your computer is connected to your mobile device. For more details, refer to the section **Wi-Fi GO! Remote**.

Application help

Destination path for the files transferred from mobile device to desktop

Destination path for the files transferred from desktop to mobile device

Click to go back to main menu

Click to select a destination path for your file transfer



- Android mobile devices can send and receive files.
- iOS mobile devices can only send files.

## Using File Transfer

1. Right-click the file and click **Send to > [Device name]**.
2. After the transfer is complete, click **OK**.

## Using File Transfer via W-Fi GO! Remote

1. On your mobile device, tap **File Transfer**.
2. Tap **Enable** to receive files from PC.
3. Tap **Enter** to send files to PC.



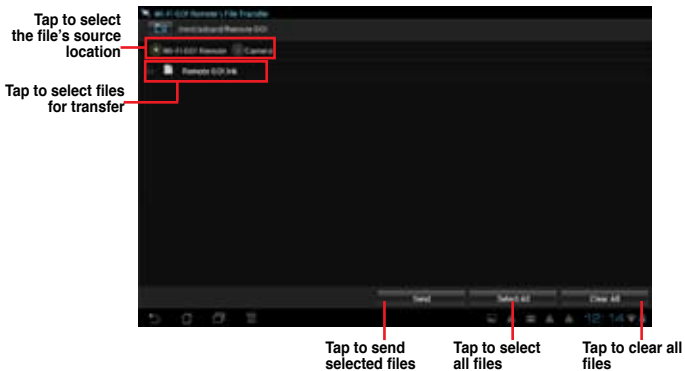

The W-Fi GO! Remote's user interface shown above is for reference only and may vary with the mobile device's operating system.

## Securing your computer for Wi-Fi GO! Remote functions

Remote GO! Settings allows you to create a password for your computer.

To create a password:

1. Click  in the main menu.
2. Tick **Use Password** and key in your password.
3. Click **Apply**.

# RAID support

# 5

## 5.1 RAID configurations

The motherboard comes with the AMD® chipset that allows you to configure Serial ATA hard disk drives as RAID sets. The motherboard supports the following RAID configurations: RAID 0, RAID 1, RAID 5 and RAID 10.



- You must install Windows® XP Service Pack 3 or later versions before using Serial ATA hard disk drives. The Serial ATA RAID feature is available only if you are using Windows® XP SP3 or later versions.
- Due to Windows® XP limitation, a RAID array with the total capacity over 2TB cannot be set as a boot disk. A RAID array over 2TB can only be set as a data disk only.
- If you want to install a Windows® operating system to a hard disk drive included in a RAID set, you have to create a RAID driver disk and load the RAID driver during OS installation. Refer to section 5.2 **Creating a RAID driver disk** for details.

### 5.1.1 RAID definitions

**RAID 0 (Data striping)** optimizes two identical hard disk drives to read and write data in parallel, interleaved stacks. Two hard disks perform the same work as a single drive but at a sustained data transfer rate, double that of a single disk alone, thus improving data access and storage. Use of two new identical hard disk drives is required for this setup.

**RAID 1 (Data mirroring)** copies and maintains an identical image of data from one drive to a second drive. If one drive fails, the disk array management software directs all applications to the surviving drive as it contains a complete copy of the data in the other drive. This RAID configuration provides data protection and increases fault tolerance to the entire system. Use two new drives or use an existing drive and a new drive for this setup. The new drive must be of the same size or larger than the existing drive.

**RAID 5** stripes both data and parity information across three or more hard disk drives. Among the advantages of RAID 5 configuration include better HDD performance, fault tolerance, and higher storage capacity. The RAID 5 configuration is best suited for transaction processing, relational database applications, enterprise resource planning, and other business systems. Use a minimum of three identical hard disk drives for this setup.

**RAID 10** is data striping and data mirroring combined without parity (redundancy data) having to be calculated and written. With the RAID 10 configuration you get all the benefits of both RAID 0 and RAID 1 configurations. Use four new hard disk drives or use an existing drive and three new drives for this setup.

## 5.1.2 Installing Serial ATA hard disks

The motherboard supports Serial ATA hard disk drives. For optimal performance, install identical drives of the same model and capacity when creating a disk array.

### To install the SATA hard disks for a RAID configuration:

1. Install the SATA hard disks into the drive bays.
2. Connect the SATA signal cables.
3. Connect a SATA power cable to the power connector on each drive.

## 5.1.3 Setting the RAID item in BIOS

You must enable the RAID function in the BIOS Setup before creating RAID sets using SATA HDDs. To do this:

1. Enter the BIOS Setup during POST.
2. Go to the **Advanced** menu > **SATA Configuration**, and then press <Enter>.
3. Set the SATA Mode item to [RAID Mode].
4. Save your changes, and then exit the BIOS Setup.



---

Refer to Chapter 3 for details on entering and navigating through the BIOS Setup

---



---

Due to chipset limitation, when SATA ports are set to RAID mode, all SATA ports run at RAID mode together.

---



## 5.1.4 AMD® Option ROM utility

To enter the AMD® Option ROM utility:

1. Turn on the system.
2. During POST, press <Ctrl> + <F> to display the utility main menu.

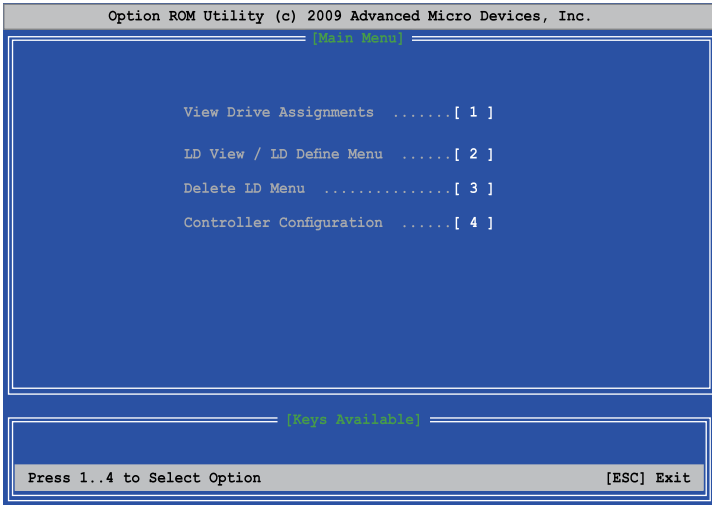

The Main Menu allows you to select an operation to perform. The Main Menu options include:

- **View Drive Assignments:** shows the status of the hard disk drives.
- **LD View / LD Define Menu:** displays the existing RAID set information / creates a RAID 0, RAID 1, RAID 5 or RAID 10 configuration.
- **Delete LD Menu:** deletes a selected RAID set and partition.
- **Controller Configuration:** shows the system resources configuration.

Press <1>, <2>, <3>, or <4> to enter the option you need; press <ESC> to exit the utility.



The RAID BIOS setup screens shown in this section are for reference only and may not exactly match the items on your screen.



The utility supports maximum four hard disk drives for RAID configuration.

## Creating a RAID volume

### To create a RAID volume:

1. In the Main Menu, press <2> to enter the **LD View / LD Define Menu** function.
2. Press <Ctrl> + <C>, and the following screen appears.

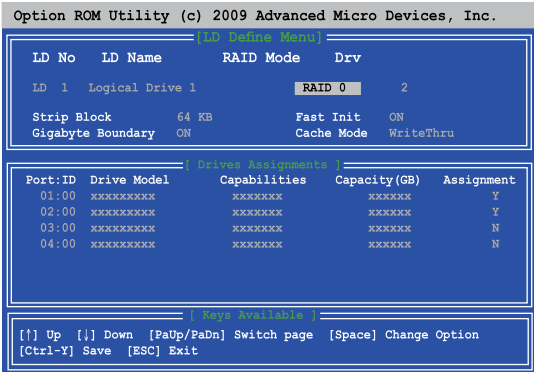

3. Move to the **RAID Mode** item and press <Space> to select a RAID mode to create.
4. Move to the **Assignment** item by using the down arrow key and set **Y** to select the hard disk drives you want to include in the RAID set.
5. Press <Ctrl> + <Y> to save the setting.
6. The utility prompts the following message. Press <Ctrl> + <Y> to input the LD name.

```
Please press Ctrl-Y key to input the LD Name
or press any key to exit.
If you do not input any LD name, the default LD
name will be used.
```

7. Enter an LD name, and then press any key to continue.

```
Enter the LD name here:
```

8. Press <Ctrl> + <Y> to erase the MBR, or you may press any key to abort the settings.

```
Fast Initialization Option has been selected
It will erase the MBR data of the disks.
<Press Ctrl-Y Key if you are sure to erase it>
<Press any other key to ignore this option>
```

9. Press <Ctrl> + <Y> to enter the screen to modify the array capacity, or press any key to use the maximum capacity.

## Deleting a RAID configuration



Be cautious when deleting a RAID volume. You will lose all data on the hard disk drives when you delete a RAID volume.

### To delete a RAID volume:

1. In the Main Menu, press <3> to enter the **Delete LD** function.
2. Select the RAID item you want to delete and press <Del> or <Alt> + <D>.

```
Option ROM Utility (c) 2009 Advanced Micro Devices, Inc.
[Delete LD Menu]
+-----+
| LD No   RAID Mode   Drv   Capacity (GB)   Status |
+-----+
| LD 1    RAID 0     2     xxxxxx          Functional |
+-----+
|                                     |
|                                     |
|                                     |
|                                     |
+-----+
[Keys Available]
[↑] Up [↓] Down [PaUp/PaDn] Switch page [Del/Alt+D] Delete LD
```

3. The utility prompts the following messages:

```
Press Ctrl-Y to delte the dats in the disk!
or press any other key to abort...
```

Press <Ctrl> + <Y> to delete the RAID volume.

## Displaying a RAID set information

### To display a RAID set information:

1. In the Main Menu, press <2> to enter the **LD View / LD Define Menu** function.
2. Select a RAID item and press <Enter> to display its information.

```
Option ROM Utility (c) 2009 Advanced Micro Devices, Inc.
[View LD Definition Menu]
+-----+
| LD No   LD Name      RAID Mode   Drv   Capacity (GB) |
+-----+
| LD 1    xxxxxx      RAID 0     2     157.99         |
+-----+
| Strip Block   64 KB   Cache Mode   WriteThru      |
+-----+
[Drives Assignments]
+-----+
| Port:ID   Drive Model   Capabilities   Capacity (GB) |
+-----+
| 01:00    xxxxxxxxxx    xxxxxxxx      xxxxxx        |
| 02:00    xxxxxxxxxx    xxxxxxxx      xxxxxx        |
+-----+
|                                     |
| Any Key To Continue.....         |
+-----+
```

## 5.2 Creating a RAID driver disk

A floppy disk with the RAID driver is required when installing a Windows® operating system on a hard disk drive that is included in a RAID set.



- The motherboard does not provide a floppy drive connector. You have to use a USB floppy disk drive when creating a SATA RAID driver disk.
- Windows® XP may not recognize the USB floppy disk drive due to Windows® XP limitation. To work around this OS limitation, refer to section 5.2.4 Using a USB floppy disk drive.

### 5.2.1 Creating a RAID driver disk without entering the OS

To create a RAID driver disk without entering the OS:

1. Boot your computer.
2. Press <Del> during POST to enter the BIOS setup utility.
3. Set the optical drive as the primary boot device.
4. Insert the support DVD into the optical drive.
5. Save changes and exit BIOS.
6. When the Make Disk menu appears, press <1> to create a RAID driver disk.
7. Insert a formatted floppy disk into the USB floppy disk drive, then press <Enter>.
8. Follow the succeeding screen instructions to complete the process.

### 5.2.2 Creating a RAID driver disk in Windows®

To create a RAID driver disk in Windows®:

1. Start Windows®.
2. Plug the USB floppy disk drive and insert a floppy disk.
3. Place the motherboard support DVD into the optical drive.
4. Go to the **Make Disk** menu, and then click **AMD AHCI/RAID 32/64bit xxxx Driver** to create a RAID driver disk.
5. Select **USB floppy disk drive** as the destination disk.
6. Follow the succeeding screen instructions to complete the process.



Write-protect the floppy disk to avoid a computer virus infection.

## 5.2.3 Installing the RAID driver during Windows® OS installation

### To install the RAID driver in Windows® XP:

1. During the OS installation, the system prompts you to press the <F6> key to install third-party SCSI or RAID driver.
2. Press <F6>, and then insert the floppy disk with RAID driver into the USB floppy disk drive.
3. When prompted to select the SCSI adapter to install, select the RAID driver for the corresponding OS version.
4. Follow the succeeding screen instructions to complete the installation.

### To install the RAID driver for Windows® 7 or later OS:

1. During the OS installation, click **Load Driver** to allow you to select the installation media containing the RAID driver.
2. Insert the USB flash drive with RAID driver into the USB port or the support DVD into the optical drive, and then click **Browse**.
3. Click the name of the device you've inserted, go to **Drivers > RAID**, and then select the RAID driver for the corresponding OS version. Click **OK**.
4. Follow the succeeding screen instructions to complete the installation.



---

Before loading the RAID driver from a USB flash drive, you have to use another computer to copy the RAID driver from the support DVD to the USB flash drive.

---

## 5.2.4 Using a USB floppy disk drive

Due to OS limitation, Windows® XP may not recognize the USB floppy disk drive when you install the RAID driver from a floppy disk during the OS installation.

To solve this issue, add the USB floppy disk drive's Vendor ID (VID) and Product ID (PID) to the floppy disk containing the RAID driver. Refer to the steps below:

1. Using another computer, plug the USB floppy disk drive, and insert the floppy disk containing the RAID driver.

2. Right-click **My Computer** on the Windows® desktop or start menu, and then select **Manage** from the pop-up window.



3. Select **Device Manager**. From the **Universal Serial Bus controllers**, right-click **xxxxxx USB Floppy**, and then select **Properties** from the pop-up window.



The name of the USB floppy disk drive varies with different vendors.

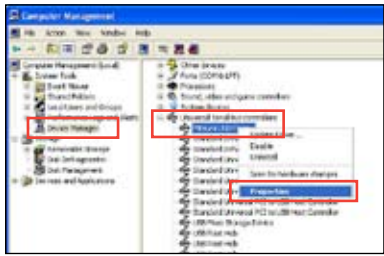

4. Click **Details** tab. The Vendor ID (VID) and Product ID (PID) are displayed.

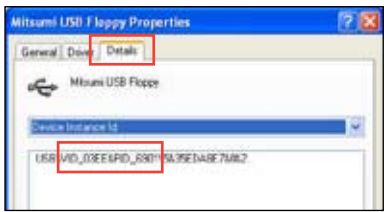

5. Browse the contents of the RAID driver disk to locate the file **txtsetup.oem**.

6. Double-click the file. A window appears, allowing you to select the program for opening the oem file.

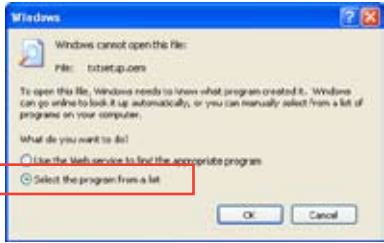

- Use Notepad to open the file.



- Find the `[HardwareIds.scsi.iaAHCI_DesktopWorkstationServer]` and `[HardwareIds.scsi.iaStor_DesktopWorkstationServer]` sections in the `txtsetup.oem` file.
- Type the following line to the bottom of the two sections:

`id = "USB\VID_xxxx&PID_xxxx", "usbstor"`

```
[HardwareIds.scsi.iaAHCI
DesktopWorkstationServer]
id="PCI\VEN_8086&DEV_1C02&CC_0106", "iaStor"
id="USB\VID_03EE&PID_6901", "usbstor"

[HardwareIds.scsi.iaStor
DesktopWorkstationServer]
id="PCI\VEN_8086&DEV_2822&CC_0104", "iaStor"
id="USB\VID_03EE&PID_6901", "usbstor"
```



Add the same line to both sections.



The VID and PID vary with different vendors.

- Save and exit the file.





# Multiple GPU support

# 6

## 6.1 AMD® CrossFireX™ technology

The motherboard supports the AMD® CrossFireX™ technology that allows you to install multi-graphics processing units (GPU) graphics cards. Follow the installation procedures in this section.

### 6.1.1 Requirements

- In Dual CrossFireX mode, you should have two identical CrossFireX-ready graphics cards or one CrossFireX-ready dual-GPU graphics card that are AMD® certified.
- Ensure that your graphics card driver supports the AMD CrossFireX technology. Download the latest driver from the AMD website ([www.amd.com](http://www.amd.com)).
- Ensure that your power supply unit (PSU) can provide at least the minimum power required by your system. See **Chapter 1** for details.



- 
- We recommend that you install additional chassis fans for better thermal environment.
  - Visit the AMD Game website (<http://game.amd.com>) for the latest certified graphics card and the supported 3D application list.
- 

### 6.1.2 Before you begin

For AMD CrossFireX to work properly, you have to uninstall all existing graphics card drivers before installing AMD CrossFireX graphics cards to your system.

#### To uninstall existing graphics card drivers:

1. Close all current applications.
2. For Windows XP, go to **Control Panel > Add/Remove Programs**.  
For Windows 7 / 8, go to **Control Panel > Programs and Features**.
3. Select your current graphics card driver/s.
4. For Windows XP, select **Add/Remove**.  
For Windows 7 / 8, select **Uninstall**.
5. Turn off your computer.

### 6.1.3 Installing two CrossFireX™ graphics cards



The following pictures are for reference only. The graphics cards and the motherboard layout may vary with models, but the installation steps remain the same.

1. Prepare two CrossFireX-ready graphics cards.
2. Insert the two graphics card into the PCIEX16 slots. If your motherboard has more than two PCIEX16 slots, refer to Chapter 1 in this user manual for the locations of the PCIEX16 slots recommended for multi-graphics card installation.
3. Ensure that the cards are properly seated on the slots.
4. Align and firmly insert the CrossFireX bridge connector to the goldfingers on each graphics card. Ensure that the connector is firmly in place.

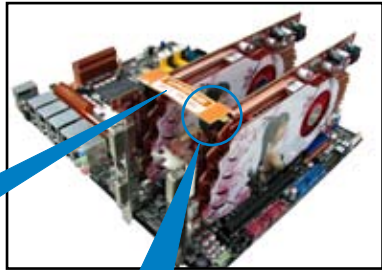
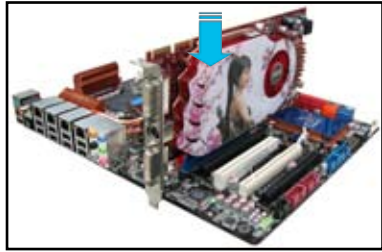

CrossFireX bridge  
(bundled with  
graphics cards)



Goldfingers

5. Connect two independent auxiliary power sources from the power supply to the two graphics cards separately.
6. Connect a VGA or a DVI cable to the graphics card.

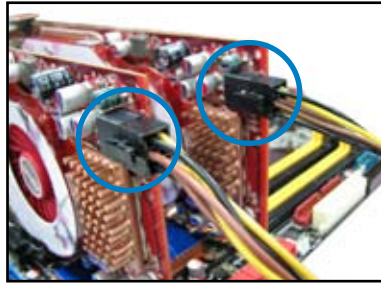

### 6.1.4 Installing the device drivers

Refer to the documentation that came with your graphics card package to install the device drivers.



Ensure that your PCI Express graphics card driver supports the AMD® CrossFireX™ technology. Download the latest driver from the AMD website ([www.amd.com](http://www.amd.com)).

### 6.1.5 Enabling the AMD® CrossFireX™ technology

After installing your graphics cards and the device drivers, enable the CrossFireX™ feature through the AMD Catalyst™ Control Center in Windows environment.

#### Launching the AMD Catalyst Control Center

To launch the AMD Catalyst Control Center:

1. Right-click on the Windows® desktop and select **Catalyst Control Center**.
2. Click **Catalyst Control Center** to configure the displays and settings of your AMD graphic cards.

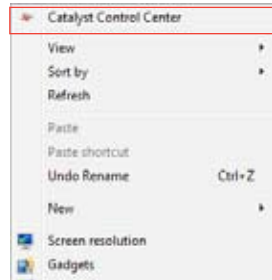

## Enabling Dual CrossFireX technology

1. In the Catalyst Control Center window, click **Performance > AMD CrossFireX™**.
2. Select **Enable CrossFireX™**.
3. Select a GPU combination from the drop-down list.
4. Click **Apply** to save and activate the GPU settings made.

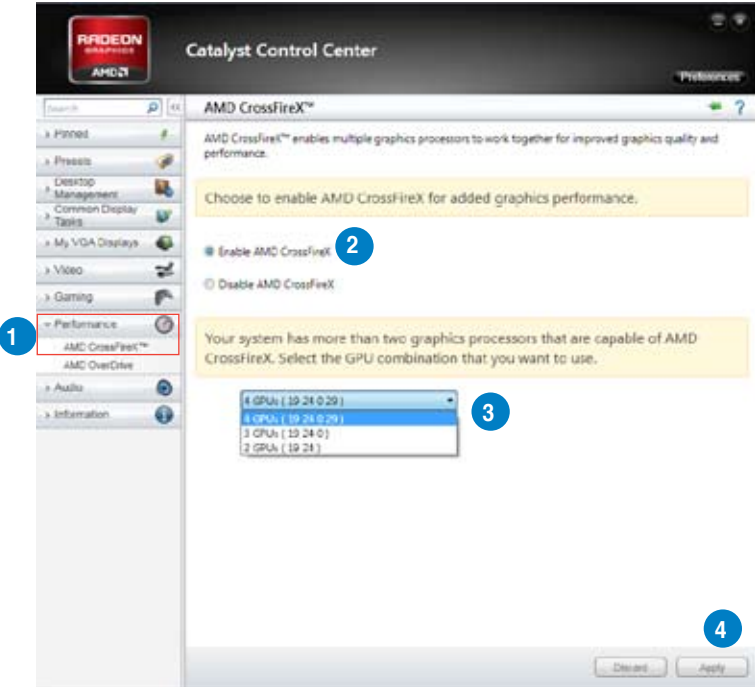

## 6.2 AMD® Dual Graphics technology

The motherboard supports the AMD® Dual Graphics technology that allows you to install multi-graphics processing units (GPU) CrossFireX cards.

### 6.2.1 System requirements

Before using AMD Dual Graphics, ensure that your system meets the following basic requirements:

- Operating System: Windows® 7
- Memory capacity: Minimum 2GB
- APU: A-Series
- On-board graphics card RAM: 256MB



Visit the AMD website for the latest graphics card support list.

### 6.2.2 Before you proceed

Configure the BIOS settings for the graphics card to support AMD Dual Graphics.

#### To set Internal Graphics:

1. Press **<Del>** during the Power-On-Self-Test (POST) to enter the BIOS Setup utility.
2. Go to **Advanced > NB configuration > IGFX Multi-Monitor**, set **IGFX Multi-Monitor** to **[Enabled]**.
3. Press **<F10>** to save the changes and exit BIOS settings. Select **OK** to confirm.

### 6.2.3 Installing AMD Chipset Driver

#### To install the driver that supports Dual Graphics technology:

1. Insert the Support DVD that comes with your motherboard into the optical drive. The DVD automatically displays the Highlights menu if Autorun is enabled on your computer.



If Autorun is NOT enabled in your computer, browse the contents of the support DVD to locate the file ASSETUP.EXE from the BIN folder. Double-click the ASSETUP.EXE to run the DVD.

2. From the Drivers menu, click **AMD Chipset Driver** to install it. Follow the onscreen instructions to finish the installation.
3. Restart your computer after the installation is completed.
4. When the system restarts, wait for a few seconds for the driver to load automatically.

## 6.2.4 Using the AMD® CATALYST® Control Center

### Using an add-on graphics card

1. Install a graphics card onto your motherboard. Refer to the User Guide that comes with your graphics card for details.
2. Right-click on the Windows® desktop, then click **AMD CATALYST(R) Control Center** from the shortcut menu. The AMD CATALYST Control Center screen appears.
3. Click **Graphics Settings > CrossFire™**, then select the **Enable CrossFire™** check box. When a confirmation message pops up, click **Yes**. The screen blacks out for about one minute.
4. Click **OK**. The add-on graphics card is set to be the main monitor.



### Using the onboard graphics card

1. Right-click on the Windows® desktop, and then click **AMD CATALYST(R) Control Center** from the shortcut menu. The AMD CATALYST Control Center screen appears.
2. Click **Graphics Settings > CrossFire™**, then clear the **Enable CrossFire™** check box. When a confirmation message pops up, click **Yes**. The screen blacks out for about one minute.
3. Click **OK**.



- Right-click on the Windows® desktop, then click **Personalize** from the shortcut menu.
- Click **Display Settings**. Select **[Default Monitor] on ATI Radeon HD 4250 Graphics**, then select the check boxes of **This is my main monitor** and **Extend the desktop onto this monitor**. Click **OK**, and then **Yes** from the confirmation window.
- Restart the system. Right-click on the Windows® desktop, then click **AMD CATALYST(R) Control Center** from the shortcut menu. The AMD CATALYST Control Center screen appears.
- Click **Graphics Settings > CrossFire™**, then select the **Enable CrossFire™** check box. When a confirmation pops up, click **Yes**. The screen blacks out for about one minute.
- Click **OK**. The onboard graphics card is set to be the main monitor.

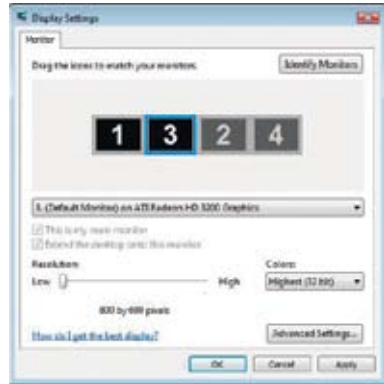

If you are using both an add-on and the onboard graphics cards at same time and want to set the onboard graphics card as your main monitor, follow the instructions below.

- Follow steps 1 to 3 on **Using the onboard graphics card**.
- From the AMD CATALYST(R) Control Center screen, click **Display Manager > Graphics Adapter**. Select **AMD Radeon HD 4250 Graphics [Gabb, G HW173]**. Click **OK**, and then **Yes** from the confirmation window.
- Follow steps 6 to step 8 on **Using the onboard graphics card** to complete the process of setting up the onboard graphics card as your main monitor.



## 6.3 LucidLogix Virtu MVP

LucidLogix Virtu MVP allows your computer's VGA output and discrete graphic cards to perform better, respond faster and process media files smoother within a low power environment. Its GPU virtualization assigns tasks to the best available graphic source while the newly-designed Virtual Vsync gives you a smoother gaming experience.



- 
- LucidLogix Virtu MVP supports Windows 7® operating systems.
  - iGPU Multi-Monitor support option must be enabled in BIOS and install both AMD Graphics Accelerator, and graphics card driver before installing LucidLogix Virtu MVP from ASUS support DVD. Refer to **3.5.4 System Configuration** for details.
  - Hyperformance® and Virtual VSync are enabled when using more than one discrete GPU at the same time.
  - Supports NVIDIA® GF4xx/5xx series and AMD® HD5xx/6xxx series graphic cards.
  - We do not recommended that you use LucidLogix Virtu MVP under RAID mode.
- 

### 6.3.1 Installing LucidLogix Virtu MVP

To install LucidLogix Virtu MVP:

1. Insert the support DVD in the optical drive. The ASUS Support Wizard appears if your computer has enabled the Autorun feature.
2. Click the **Utilites** tab, then click **LucidLogix Virtu MVP Software**.
3. Follow the succeeding onscreen instructions to complete the installation.



---

After you successfully installed the LucidLogix Virtu MVP, the LucidLogix Virtu MVP icon appears in the notification area.

---



## 6.3.2 Setting up your display

LucidLogix Virtu MVP solution comes with two distinct modes that allows you to enjoy better graphics either from your built-in video output (i-Mode) or from a discrete graphics card (d-Mode).

### i-Mode

To use LucidLogix Virtu MVP in i-Mode, the display must be connected to the onboard video output.



---

Ensure to set the Primary Display to iGPU in BIOS to activate i-Mode support.

---

### d-Mode

To use LucidLogix Virtu MVP in d-Mode, the display must be connected to the installed graphics card.



- 
- Ensure to set the Primary Display to PCIE or PCIE/PCI in BIOS to enable d-Mode support.
  - d-Mode is recommended for an enhanced 3D gaming performance.
- 

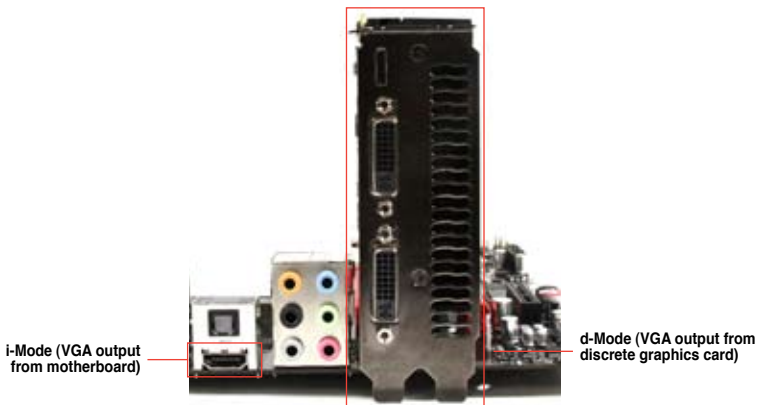

---

The motherboard's IO ports and discrete graphic card is for reference only and may vary in different models.

---

### 6.3.3 Configuring LucidLogix Virtu MVP

Launch the Virtu MVP Control Panel to allow you to configure the main features, adjust the performance settings and select applications for graphical virtualization.

To open the control panel, right-click **LucidLogix Virtu MVP** icon in the notification area and select **Open Virtu MVP Control Panel**.

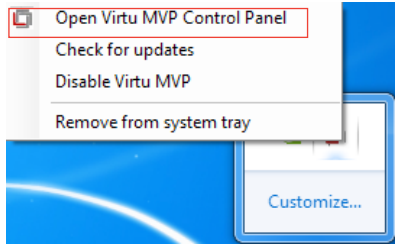

LucidLogix Virtu MVP is automatically activated when your system is powered on. Select **Remove from system tray** if you want to remove LucidLogix Virtu MVP icon from the notification area.

#### Main

Allows you to turn ON/OFF the GPU virtualization. Also from the Main tab, you can set to show or hide the In-Game icon.



Click to restore to default settings

Tick to show icon in system tray

Select display option for In-Game icon

## Performance

Allows you to turn ON/OFF the Hyperformance® or Virtual Vsync function.

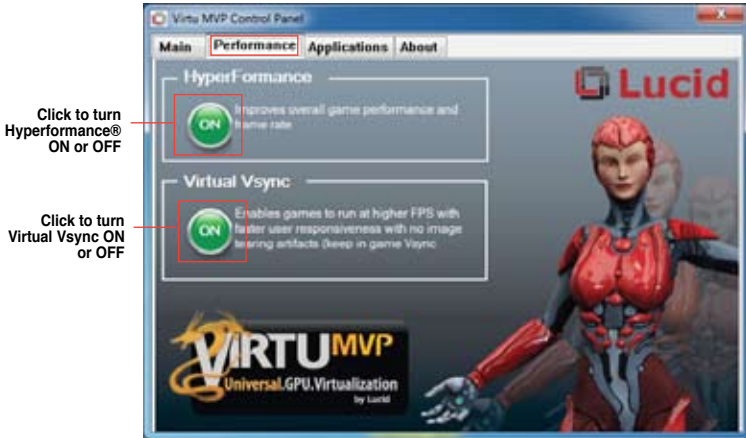

## Applications

Allows you to select applications for graphic virtualization.



See the descriptions of these columns below:

- D column allows you to run applications with the discrete graphic card. Select D to enable 3D graphical performance for that application.
- I column allows to run applications with iGPU. Select I for applications with media extensive performance.
- H column allows you to run applications with Hyperformance®. Tick H to enhance graphical performance for that application.



Actual graphical performance varies with the application used and graphics card installed.

# Appendices

## Notices

### Federal Communications Commission Statement

This device complies with Part 15 of the FCC Rules. Operation is subject to the following two conditions:

- This device may not cause harmful interference.
- This device must accept any interference received including interference that may cause undesired operation.

This equipment has been tested and found to comply with the limits for a Class B digital device, pursuant to Part 15 of the FCC Rules. These limits are designed to provide reasonable protection against harmful interference in a residential installation. This equipment generates, uses and can radiate radio frequency energy and, if not installed and used in accordance with manufacturer's instructions, may cause harmful interference to radio communications. However, there is no guarantee that interference will not occur in a particular installation. If this equipment does cause harmful interference to radio or television reception, which can be determined by turning the equipment off and on, the user is encouraged to try to correct the interference by one or more of the following measures:

- Reorient or relocate the receiving antenna.
- Increase the separation between the equipment and receiver.
- Connect the equipment to an outlet on a circuit different from that to which the receiver is connected.
- Consult the dealer or an experienced radio/TV technician for help.



---

The use of shielded cables for connection of the monitor to the graphics card is required to assure compliance with FCC regulations. Changes or modifications to this unit not expressly approved by the party responsible for compliance could void the user's authority to operate this equipment.

---

## IC: Canadian Compliance Statement

Complies with the Canadian ICES-003 Class B specifications. This device complies with RSS 210 of Industry Canada. This Class B device meets all the requirements of the Canadian interference-causing equipment regulations.

This device complies with Industry Canada license exempt RSS standard(s). Operation is subject to the following two conditions: (1) this device may not cause interference, and (2) this device must accept any interference, including interference that may cause undesired operation of the device.

Cet appareil numérique de la Classe B est conforme à la norme NMB-003 du Canada. Cet appareil numérique de la Classe B respecte toutes les exigences du Règlement sur le matériel brouilleur du Canada.

Cet appareil est conforme aux normes CNR exemptes de licence d'Industrie Canada. Le fonctionnement est soumis aux deux conditions suivantes :

- (1) cet appareil ne doit pas provoquer d'interférences et
- (2) cet appareil doit accepter toute interférence, y compris celles susceptibles de provoquer un fonctionnement non souhaité de l'appareil.

## Canadian Department of Communications Statement

This digital apparatus does not exceed the Class B limits for radio noise emissions from digital apparatus set out in the Radio Interference Regulations of the Canadian Department of Communications.

This class B digital apparatus complies with Canadian ICES-003.

## VCCI: Japan Compliance Statement

### VCCI Class B Statement

情報処理装置等電波障害自主規制について

この装置は、情報処理装置等電波障害自主規制協議会（VCCI）の基準に基づくクラスB情報技術装置です。この装置は家庭環境で使用することを目的としていますが、この装置がラジオやテレビジョン受信機に近接して使用されると、受信障害を引き起こすことがあります。

取扱説明書に従って正しい取り扱いをして下さい。

## KC: Korea Warning Statement

B급 기기 (가정용 방송통신기자재)

이 기기는 가정용(B급) 전자파적합기기로서 주로 가정에서 사용하는 것을 목적으로 하며, 모든 지역에서 사용할 수 있습니다.

\*당해 무선설비는 전파혼신 가능성이 있으므로 인명안전과 관련된 서비스는 할 수 없습니다.

## REACH

Complying with the REACH (Registration, Evaluation, Authorisation, and Restriction of Chemicals) regulatory framework, we published the chemical substances in our products at ASUS REACH website at <http://csr.asus.com/english/REACH.htm>.



---

DO NOT throw the motherboard in municipal waste. This product has been designed to enable proper reuse of parts and recycling. This symbol of the crossed out wheeled bin indicates that the product (electrical and electronic equipment) should not be placed in municipal waste. Check local regulations for disposal of electronic products.

---



---

DO NOT throw the mercury-containing button cell battery in municipal waste. This symbol of the crossed out wheeled bin indicates that the battery should not be placed in municipal waste.

---

## ASUS Recycling/Takeback Services

ASUS recycling and takeback programs come from our commitment to the highest standards for protecting our environment. We believe in providing solutions for you to be able to responsibly recycle our products, batteries, other components as well as the packaging materials. Please go to <http://csr.asus.com/english/Takeback.htm> for detailed recycling information in different regions.

## ASUS contact information

### ASUSTeK COMPUTER INC.

Address 15 Li-Te Road, Peitou, Taipei, Taiwan 11259  
Telephone +886-2-2894-3447  
Fax +886-2-2890-7798  
E-mail info@asus.com.tw  
Web site www.asus.com.tw

#### *Technical Support*

Telephone +86-21-38429911  
Online support support.asus.com

### ASUS COMPUTER INTERNATIONAL (America)

Address 800 Corporate Way, Fremont, CA 94539, USA  
Telephone +1-812-282-3777  
Fax +1-510-608-4555  
Web site usa.asus.com

#### *Technical Support*

Telephone +1-812-282-2787  
Support fax +1-812-284-0883  
Online support support.asus.com

### ASUS COMPUTER GmbH (Germany and Austria)

Address Harkort Str. 21-23, D-40880 Ratingen, Germany  
Fax +49-2102-959911  
Web site www.asus.de  
Online contact www.asus.de/sales

#### *Technical Support*

Telephone +49-1805-010923\*  
Support Fax +49-2102-9599-11  
Online support support.asus.com

\* EUR 0.14/minute from a German fixed landline; EUR 0.42/minute from a mobile phone.



# DECLARATION OF CONFORMITY

Per FCC Part 2 Section 2, 1.077(a)



Responsible Party Name: **Asus Computer International**

Address: **800 Corporate Way, Fremont, CA 94539.**

Phone/Fax No: **(510)739-3777/(510)608-4555**

hereby declares that the product

**Product Name : Motherboard**

**Model Number : F2A85-M PRO**

Conforms to the following specifications:

- FCC Part 15, Subpart B, Unintentional Radiators
- FCC Part 15, Subpart C, Intentional Radiators
- FCC Part 15, Subpart E, Intentional Radiators

### Supplementary Information:

This device complies with part 15 of the FCC Rules. Operation is subject to the following two conditions: (1) This device may not cause harmful interference, and (2) this device must accept any interference received, including interference that may cause undesired operation.

Representative Person's Name : Steve Chang / President

Signature :   
Date : May 7, 2012

Ver: 110101

# EC Declaration of Conformity



We, the undersigned,

Manufacturer: **ASUSTek COMPUTER INC.**  
Address: **No. 150, LITE RD., PEITOU, TAIPEI 112, TAIWAN R.O.C.**  
Country: **TAIWAN**  
Authorized representative in Europe: **ASUS COMPUTER GmbH**  
Address: **HARKORT STR. 21/23, 40880 RATINGEN**  
Country: **GERMANY**

declare the following apparatus:

Product name : **Motherboard**  
Model name : **F2A85-M PRO**

conform with the essential requirements of the following directives:

**2004/109/EC-EMC Directive**  
 EN 55022:2010, 2006+A1:2009+A2:2009  
 EN 55013:2001+A1:2003+A2:2006  
 EN 55020:2007

**1999/5/EC-R & TTE Directive**

EN 300 328 V1.7.1 (2006-10)  
 EN 300 440-1 V1.4.1 (2008-05)  
 EN 300 440-2 V1.2.1 (2008-03)  
 EN 301 908-1 V3.2.1 (2007-05)  
 EN 301 908-2 V3.2.1 (2007-05)  
 EN 301 893 V1.4.1 (2005-03)  
 EN 301 893 V1.1.1 (2005-01)  
 EN 50360:2001  
 EN 50371:2002  
 EN 50385:2002  
 EN 301 489-1 V1.8.1 (2008-04)  
 EN 301 489-3 V1.4.1 (2002-08)  
 EN 301 489-4 V1.3.1 (2002-08)  
 EN 301 489-9 V1.4.1 (2007-11)  
 EN 301 489-17 V2.1.1 (2009-05)  
 EN 301 489-24 V1.4.1 (2007-08)  
 EN 301 489-25 V1.4.1 (2007-08)  
 EN 302 326-3 V1.3.1 (2007-09)  
 EN 301 357-2 V1.3.1 (2006-05)  
 EN 302 623 V1.1.1 (2009-01)

**2006/95/EC-LVD Directive**

EN 60950-1 /A11:2009  
 EN 60950-1 /A12:2011  
 EN 60065:2002/A1:2008  
 EN 60065:2002 / A12:2011

**2009/125/EC-ERP Directive**

Regulation (EC) No. 1275/2008  
 EN 62301:2005  
Regulation (EC) No. 842/2009  
 EN 62301:2005  
Regulation (EC) No. 2782/2009  
 EN 62301:2005  
Ver: 111121

**CE marking**



(EC conformity marking)

Position : **CEO**  
Name : **Jerry Shen**



Signature : \_\_\_\_\_

Declaration Date: **May 7, 2012**  
Year to begin affixing CE marking: **2012**